

CATALOGO FILTRI PER CAMBI AUTOMATICI

AUTOMATIC TRANSMISSION FILTER CATALOGUE



ed.1

I filtri AB PARTS sono realizzati seguendo le prescrizioni delle normative ISO/TS16949 ed hanno quindi superato i controlli e le verifiche che ne garantiscono l'elevata qualità.

AB PARTS filters are manufactured according prescriptions of ISO/TS16949 guidelines, so they have passed checking and verification which can grant their quality.

Indice / Index

Dettaglio prodotti / Products detail

Introduzione / Introduction	2
Applicazioni / Applications	7
Dettaglio prodotti / Product Details	101
Comparazioni / Cross reference	161

Il presente catalogo si prefigge la corretta identificazione e verifica della parte di ricambio necessaria alla riparazione della vettura ed individua i prodotti/articoli commercializzati e distribuiti con il marchio ABPARTS. Le marche citate nel presente catalogo sono di proprietà dei costruttori di auto, o di dispositivi ad esse dedicati, cui si riferiscono. Il loro utilizzo nel presente catalogo, così come i riferimenti originali inclusi (cross references), hanno l'unico scopo di aiutare e agevolare l'identificazione del modello d'auto sul quale può essere installata la parte di ricambio ABPARTS corrispondente. Le immagini sono riportate a scopo illustrativo e potrebbero non rappresentare il maniera fedele il prodotto.

This catalogue has the purpose to permit the correct identification and verification of the spare-parts needed for vehicles maintenance and identifies parts under ABPARTS brand only. Brands mentioned in this catalogue are property of vehicle manufacturers, and are referred to those. Their use in this catalogue, as well as OE cross-references, has the sole purpose of identify the vehicle series where an ABPARTS spare-part can be fitted. Shown images are only illustratives and may not represent the product faithfully.

I cambi automatici sono sempre più popolari e sfruttando differenti tecnologie, negli anni sono stati migliorati permettendo di ottenere maggiore comfort e facilità di utilizzo. Possono essere a convertitore di coppia, con meccanismi robotizzati, a doppia frizione o a variazione continua del rapporto (CVT).

Nelle trasmissioni automatiche sono presenti numerosi attuatori idraulici e sistemi di pompaggio dell'olio che consentono di effettuare e gestire i cambi di marcia, l'olio assume un ruolo chiave nel funzionamento, non serve solo a lubrificare riducendo gli attriti, ma contribuisce direttamente alla trasmissione della potenza alle ruote.

A differenza del cambio manuale, l'olio è maggiormente stressato dalle temperature e alte pressioni che cambiano costantemente durante la guida. Infatti, per mantenere efficienti i sistemi idraulici ed evitare che i passaggi del lubrificante si possano ostruire con la formazione di morchie, nei cambi automatici sono presenti dei sistemi di filtri che servono a ripulire l'olio dalle impurità, le quali si formano con l'usura dei componenti metallici e dei pacchi frizione, se presenti. Senza la sostituzione dei filtri, l'olio nuovo verrebbe inquinato dopo breve tempo a causa delle impurità che sono state trattenute nel tempo dal filtro.

CARTUCCIA



CARATTERISTICHE:

Simili alle cartucce per l'olio motore, lavorano spesso assieme ai filtri a pannello per una maggiore filtrazione.

COPPA CON FILTRO INTEGRATO



CARATTERISTICHE:

Con il loro filtro integrato, consentono una manutenzione più veloce in quanto viene sostituita l'intera coppa olio.

FILTRO A PANNELLO



CARATTERISTICHE:

Filtri che si trovano internamente al cambio e che lavorano in abbinamento alle cartucce.

I punti di forza dei nostri filtri:

- *Prodotti in stabilimenti certificati secondo gli standard IATF16949, ISO9001, ISO14001, ISO45001;*
- *Prodotti con acciaio AISI 304 o lega al cromo-vanadio, stampati a freddo e con piegatura a CNC;*
- *Vibrosaldatura sui filtri con corpo in plastica;*
- *Media filtrante in cellulosa con il 20% di fibre di vetro; grammatura tra 190 e 300gr/m2 a seconda dell'applicazione;*
- *OR sempre inclusi, prodotti in gomma nitrilica NBR70 e NBR75;*
- *Guarnizioni a corredo in carta, gomma e gomma-metallo per garantire la massima tenuta.*

I nostri filtri sono disponibili in due pratiche tipologie di packaging:

SCATOLA



Per una miglior maneggevolezza del prodotto durante tutte le sue fasi di vendita e per proteggere al meglio le parti più sensibili.

BLISTER



La soluzione del blister consente di preservare al meglio le guarnizioni, pieghe e deformazioni potrebbero compromettere la corretta tenuta.

Tutte le nostre confezioni sono munite di una pratica etichetta a colori che riporta le principali informazioni e che aiuta a riconoscere velocemente il ricambio a scaffale. Inoltre, tutti i filtri sono sigillati all'interno di sacchetti di plastica per evitare contaminazioni esterne, nel caso di filtri metallici sono pre-oliati per preservare le caratteristiche del metallo nel tempo.



A B - PARTS
FILTRO CAMBIO AUTOMATICO
AUTOMATIC TRANSMISSION FILTER

AB6005AT

Per cambio: **ZF 8HP45**
Fit on:

Applicazioni: ALFA ROMEO, BMW,
CHRYSLER, IVECO, JAGUAR,
JEEP, LAND ROVER, MAN,
MASERATI, VW

QUALITY SYSTEM CONTROL
ISO/TS 16949

Realizzati in stabilimenti che operano secondo le procedure definite dalle normative ISO 9001 e IATF 16949 Per assicurarvi prestazioni massime

0,1a / 0,1x1pz

8 0 5 2 6 7 9 1 5 8 9 7 0 8

www.abparts.it - info@abparts.it

Lotto / Batch: 03C
Made in FR

Automatic transmissions are becoming more and more popular and they use different technologies, they have been improved over the years, with greater comfort and easy to use. They can be with torque converters, with robotic mechanisms, dual clutch or continuously variable ratio (CVT).

Automatic transmissions have many hydraulic actuators and oil pumping systems that allow and manage gear changes, the oil have a key role, it not only used to lubricate by reducing friction, but is used directly for the transmission of power to the wheels.

Unlike manual transmissions, oil is more stressed by temperatures and high pressures that constantly change while we drive. To keep the hydraulic systems efficient and prevent the lubricant channels from becoming clogged with the formation of oil waste, automatic transmissions have filter systems used to clean the oil from impurities, which are created by the wear of the metal components and clutch packs, if present. Without replacing the filters, the new oil would become contaminated after a short time due to the oil waste that have been stopped by the filter over time.

OIL CARTRIDGE



FEATURES:

Similar to engine oil cartridges, they often work in pairs with panel filters for a better filtration.

OIL PAN WITH INTEGRATED FILTER



FEATURES:

With their integrated filter, they allow faster maintenance as the whole oil pan is replaced.

PANEL FILTER



FEATURES:

This filters are located inside the gearbox and works in pair with the cartridges.

Strengths of our filters:

- Produced in factories certified according to IATF 16949, ISO9001, ISO14001, ISO45001 standards;
- Made from AISI 304 steel or chrome-vanadium alloy, cold-stamped and CNC-bent;
- Vibro Welding on filters with plastic body;
- Cellulose filter media with 20% glass fibres; weight from 190 to 300gr/m2 based on the application;
- O'Rings always included, produced in nitrile rubber NBR70 and NBR75;
- Paper, rubber and rubber-metal gaskets supplied to ensure maximum sealing.

Our filters are available in two types of packaging:

BOX



For better handling of the product during all sales phases and to protect better all the parts.

BLISTER



The blister solution allows to better preserve the gaskets, folds and deformations could compromise the sealing.

All our packages have a practical color label that shows the main information and helps to quickly recognize the spare parts on the shelf. In addition, all filters are closed inside plastic bags to avoid external contamination, for metal filters they are pre-oiled to preserve characteristics of the metal over time.



A B - PARTS
FILTRO CAMBIO AUTOMATICO
AUTOMATIC TRANSMISSION FILTER

AB6005AT

Per cambio: **ZF 8HP45**
Fit on:

Applicazioni: ALFA ROMEO, BMW,
Applications: CHRYSLER, IVECO, JAGUAR,
JEEP, LAND ROVER, MAN,
MASERATI, VW

QUALITY SYSTEM CONTROL
ISO/TS 16949

Realizzati in stabilimenti che operano secondo le procedure definite dalle normative ISO 9001 e IATF 16949
Per assicurarvi prestazioni massime

Q.ta / Qty: 1 pz.

8 0 5 2 6 7 9 1 5 8 9 7 0 8

www.abparts.it - info@abparts.it

Lotto / Batch: 03C
Made in FR

APPLICAZIONI - FILTRI PER CAMBI AUTOMATICI

APPLICATIONS - AUTOMATIC TRANSMISSION FILTERS

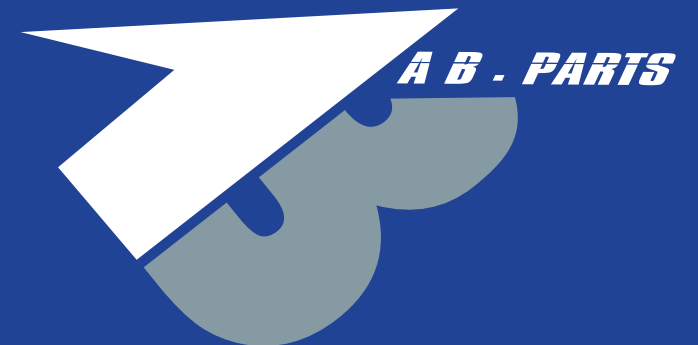

Istruzioni per la corretta interpretazione del catalogo

Nella prima colonna (1) sono riportati tutti codici di base per fare una manutenzione completa del vostro cambio automatico.
Per alcuni cambi automatici sono presenti più filtri, per questa casistica i codici vengono riportati come in esempio.

Marce / Gears:	Codice AB PARTS	Lubrificazione Consigliata
7	AB6102AT + AB6103AT * + AB6105AT *	VW G055529 G055549
	AB6104AT * AB6106AT *	

AB6102AT
S-TRONIC DL382

Altri riferimenti:
DCI, DCX, DCL

N. Rapporti	7
N. Fori Guarnizione	-

Note o Discriminanti:
Filtro interno

Intervallo di manutenzione:
60000 / 4 ANNI

Composizione del kit:
Filtro + Guarnizione in gomma

Acquisto consigliato insieme a:
AB6103AT + AB6105AT

Alternative al prodotto:
AB6104AT

AB6103AT
S-TRONIC DL382

Altri riferimenti:
DCI, DCX, DCL

N. Rapporti	7
N. Fori Guarnizione	-

Note o Discriminanti:
Filtro esterno

Intervallo di manutenzione:
60000 / 4 ANNI

Composizione del kit:
Cartuccia + O' Ring

Acquisto consigliato insieme a:
AB6102AT + AB6105AT

Alternative al prodotto:
AB6104AT

AB6105AT
S-TRONIC DL382

Altri riferimenti:
DCI, DCX, DCL

N. Rapporti	7
N. Fori Guarnizione	-

Note o Discriminanti:
Filtro esterno

Intervallo di manutenzione:
60000 / 4 ANNI

Composizione del kit:
Cartuccia + O' Ring

Acquisto consigliato insieme a:
AB6102AT + AB6103AT

Alternative al prodotto:
AB6106AT

Nella seconda sezione (2) troverete allineati con i codici di base i prodotti alternativi, si tratta prodotti di base con accessori in aggiunta o con varianti tecniche.

Nell'esempio riportato:

- AB6102AT** nessuna alternativa disponibile
- + **AB6103AT** o alternativa **AB6104AT** (previa verifica nella sezione Dettaglio Prodotti)
- + **AB6105AT** o alternativa **AB6106AT** (previa verifica nella sezione Dettaglio Prodotti)

Tutte le combinazioni di abbinamento disponibili si possono trovare al fondo della scheda tecnica di ogni codice nella sezione Dettaglio Prodotti (3).

L'asterisco accanto ai codici richiama la vostra attenzione sui prodotti per il quale è necessario visitare la sezione Dettaglio Prodotti per approfondire discriminanti tecniche e le loro varianti.

AB6104AT
S-TRONIC DL382

Altri riferimenti:
DCI, DCX, DCL

N. Rapporti	7
N. Fori Guarnizione	-

Note o Discriminanti:
Filtro esterno

Intervallo di manutenzione:
60000 / 4 ANNI

Composizione del kit:
Cartuccia + O' Ring + Calotta

Acquisto consigliato insieme a:

AB6106AT
S-TRONIC DL382

Altri riferimenti:
DCI, DCX, DCL

N. Rapporti	7
N. Fori Guarnizione	-

Note o Discriminanti:
Filtro esterno

Intervallo di manutenzione:
60000 / 4 ANNI

Composizione del kit:
Cartuccia + O' Ring + Calotta

Acquisto consigliato insieme a:

Marca / Brand:	Modello / Model:	Versioni / Version:	Da anno / From:	Ad anno / To:	Marce / Gears:	Codice AB PARTS		Lubrificante Consigliato
ALFA ROMEO	GIULIA (952_)	2.0; 2.0 Q4; 2.2 D; 2.2 D Q4; 2.9; 2.9 GTA; 2.9 Quadrifoglio	ott-15	In produzione	8	AB6164AT	-	ZF Lifeguard Fluid 8
ALFA ROMEO	STELVIO (949_)	2.0 Q4; 2.2 D; 2.2 D Q4; 2.2 JTDM Q4; 2.9 Q4	dic-16	In produzione	8	AB6164AT	-	ZF Lifeguard Fluid 8
ASTON MARTIN	DB9 Vantage	6.0 V12	gen-04	ott-16	6	AB6163AT	-	ZF Lifeguard Fluid 6
ASTON MARTIN	DB9 Volante	6.0; 6.0 V12	apr-04	ott-16	6	AB6163AT	-	ZF Lifeguard Fluid 6
ASTON MARTIN	RAPIDE	6.0; 6.0 S	mar-10	In produzione	6	AB6163AT	-	ZF Lifeguard Fluid 6
AUDI	100 C3 Avant (445, 446)	1.8; 1.8 Cat; 1.9; 2.0; 2.0 D; 2.0 E; 2.0 E Cat; 2.0 TD; 2.1; 2.2; 2.2 Turbo; 2.3; 2.4 D; 2.5 TDI	ago-82	nov-90	4	AB6132AT *	AB6133AT *	VW G052162A2 + 75W90 Gl4
AUDI	100 C3 Tre volumi (443, 444)	1.8; 1.8 Cat; 1.9; 2.0; 2.0 Cat; 2.0 D; 2.0 D Turbo; 2.1; 2.2; 2.2 Turbo; 2.3 E; 2.4 D; 2.5 TDI	ago-82	lug-91	4	AB6132AT *	AB6133AT *	VW G052162A2 + 75W90 Gl4
AUDI	100 C4 Avant (4A5)	2.0 E; 2.0 E 16V; 2.0 E 16V quattro; 2.0 E quattro; 2.3 E; 2.3 E quattro; 2.4 D; 2.5 TDI; 2.6; 2.6 quattro; 2.8 E; 2.8 E quattro	dic-90	lug-94	4	AB6141AT + AB6142AT	-	Total Fluide AT42
AUDI	100 C4 Avant (4A5)	2.0 E; 2.0 E 16V; 2.0 E 16V quattro; 2.0 E quattro; 2.3 E; 2.3 E quattro; 2.4 D; 2.5 TDI; 2.6; 2.6 quattro; 2.8 E; 2.8 E quattro	dic-90	lug-94	4	AB6132AT *	AB6133AT *	VW G052162A2 + 75W90 Gl4
AUDI	100 C4 Tre volumi (4A2)	2.0; 2.0 E; 2.0 E 16V; 2.0 E 16V quattro; 2.0 E quattro; 2.3 E; 2.3 E quattro; 2.4 D; 2.5 TDI; 2.6; 2.6 quattro; 2.8 E; 2.8 E quattro	dic-90	lug-94	4	AB6141AT + AB6142AT	-	Total Fluide AT42
AUDI	100 C4 Tre volumi (4A2)	2.0; 2.0 E; 2.0 E 16V; 2.0 E 16V quattro; 2.0 E quattro; 2.3 E; 2.3 E quattro; 2.4 D; 2.5 TDI; 2.6; 2.6 quattro; 2.8 E; 2.8 E quattro	dic-90	lug-94	4	AB6132AT *	AB6133AT *	VW G052162A2 + 75W90 Gl4
AUDI	80 B3 Tre volumi (893, 894, 8A2)	1.4; 1.6; 1.6 D; 1.6 TD; 1.8; 1.8 E; 1.8 E quattro; 1.8 quattro; 1.8 S; 1.8 S quattro; 1.9 D; 2.0 E; 2.0 E 16V; 2.0 E 16V quattro; 2.0 E quattro; 2.0 quattro; 2.3 quattro	giu-86	ott-91	4	AB6135AT	-	VW G052162A2 + 75W90 Gl4
AUDI	80 B3 Tre volumi (893, 894, 8A2)	1.6; 1.6 TD; 1.8; 1.8 E; 1.8 E quattro; 1.8 S; 1.8 S quattro; 1.9 D; 2.0 E; 2.0 E 16V; 2.0 E 16V quattro; 2.0 quattro	giu-86	ott-91	4	AB6132AT *	AB6133AT *	VW G052162A2 + 75W90 Gl4
AUDI	80 B4 Avant (8C5)	1.6 E; 1.9 TD; 1.9 TD; 2.0; 2.0 E; 2.0 E 16V; 2.0 E 16V quattro; 2.0 quattro; 2.3 E; 2.3 E quattro; 2.6; 2.6 quattro; 2.8; 2.8 quattro; RS2 quattro; S2 quattro	set-91	gen-96	4	AB6135AT	-	VW G052162A2 + 75W90 Gl4
AUDI	80 B4 Avant (8C5)	1.6 E; 1.9 TD; 1.9 TD; 2.0; 2.0 E; 2.0 E 16V; 2.0 E 16V quattro; 2.3 E; 2.3 E quattro; 2.6; 2.6 quattro; 2.8; 2.8 quattro; S2 quattro	set-91	gen-96	4	AB6132AT *	AB6133AT *	VW G052162A2 + 75W90 Gl4
AUDI	80 B4 Tre volumi (8C2)	1.6; 1.6 E; 1.9 TD; 1.9 TD; 2.0; 2.0 E; 2.0 E 16V; 2.0 E 16V quattro; 2.0 E quattro; 2.0 quattro; 2.3 E; 2.3 E quattro; 2.6; 2.6 quattro; 2.8; 2.8 quattro; S2 quattro	set-91	dic-94	4	AB6135AT	-	VW G052162A2 + 75W90 Gl4
AUDI	80 B4 Tre volumi (8C2)	1.6; 1.6 E; 1.9 TD; 1.9 TD; 2.0; 2.0 E; 2.0 E 16V; 2.0 E 16V quattro; 2.0 E quattro; 2.3 E; 2.3 E quattro; 2.6; 2.6 quattro; 2.8; 2.8 quattro; S2 quattro	set-91	dic-94	4	AB6132AT *	AB6133AT *	VW G052162A2 + 75W90 Gl4
AUDI	90 B3 (893, 894, 8A2)	1.6 TD; 2.0; 2.0 20 V; 2.0 20 V quattro; 2.2 E; 2.2 E quattro; 2.3 E; 2.3 E 20V; 2.3 E 20V quattro; 2.3 E quattro	apr-87	set-91	4	AB6132AT *	AB6133AT *	VW G052162A2 + 75W90 Gl4
AUDI	90 B3 (893, 894, 8A2)	2.0 quattro	ago-89	lug-90	4	AB6135AT	-	VW G052162A2 + 75W90 Gl4
AUDI	A1 (8X1, 8XK)	1.0 TFSI; 1.2 TFSI; 1.4 TDI; 1.4 TFSI; 1.4 TSI; 1.6 TDI; 1.8 TFSI; 2.0 TDI; 2.0 TFSI quattro; S1 quattro	mag-10	ott-18	7	AB6024AT	-	Meccatronica: VW G004000 Cambio: VW G052171
AUDI	A1 Allstreet (GBH)	25 TFSI; 35 TFSI	lug-22	In produzione	7	AB6024AT	-	Meccatronica: VW G004000 Cambio: VW G052171
AUDI	A1 City Carver (GBH)	25 TFSI; 30 TFSI; 35 TFSI	lug-19	giu-22	7	AB6024AT	-	Meccatronica: VW G004000 Cambio: VW G052171
AUDI	A1 Sportback (8XA, 8XF)	1.0 TFSI; 1.2 TFSI; 1.4 TDI; 1.4 TFSI; 1.4 TSI; 1.6 TDI; 1.8 TFSI; 2.0 TDI; S1 quattro	set-11	ott-18	7	AB6024AT	-	Meccatronica: VW G004000 Cambio: VW G052171
AUDI	A1 Sportback (GBA)	25 TFSI; 30 TFSI; 35 TFSI; 40 TFSI	lug-18	In produzione	7	AB6024AT	-	Meccatronica: VW G004000 Cambio: VW G052171

Marca / Brand:	Modello / Model:	Versioni / Version:	Da anno / From:	Ad anno / To:	Marce / Gears:	Codice AB PARTS		Lubrificante Consigliato
AUDI	A1 Sportback (GBA)	40 TFSI	set-18	In produzione	6	AB6025AT + AB6026AT	-	VW G052182
AUDI	A3 (8L1)	1.6; 1.8; 1.8 T; 1.8 T quattro; 1.9 TDI; 1.9 TDI quattro; S3 quattro	set-96	mag-03	4	AB6134AT	-	VW G052162A2 + 75W90 Gl4
AUDI	A3 (8L1)	1.6; 1.8; 1.8 T; 1.9 TDI; S3 quattro	set-96	mag-03	5	AB6071AT	-	ATF Type K17
AUDI	A3 (8P1)	1.2 TSI; 1.4 TFSI; 1.6; 1.6 E-Power; 1.6 FSI; 1.6 TDI; 1.8 TFSI; 1.8 TFSI quattro; 1.9 TDI; 2.0 FSI; 2.0 TDI; 2.0 TDI 16V; 2.0 TDI 16V quattro; 2.0 TDI quattro; 2.0 TFSI; 2.0 TFSI quattro; 3.2 V6 quattro; S3 quattro	mag-03	ago-12	7	AB6024AT	-	Meccatronica: VW G004000 Cambio: VW G052171
AUDI	A3 (8P1)	1.4 TFSI; 1.8 TFSI; 1.8 TFSI quattro; 1.9 TDI; 2.0 TDI; 2.0 TDI 16V; 2.0 TDI 16V quattro; 2.0 TDI quattro; 2.0 TFSI; 2.0 TFSI quattro; 3.2 V6 quattro; S3 quattro	mag-03	ago-12	6	AB6025AT + AB6027AT	-	VW G052182
AUDI	A3 (8P1)	1.6; 1.6 FSI; 1.8 TFSI; 1.9 TDI; 2.0 FSI; 2.0 TDI; 2.0 TDI 16V; 2.0 TDI 16V quattro; 2.0 TDI quattro; 2.0 TFSI; 2.0 TFSI quattro; 3.2 V6 quattro; S3 quattro	mag-03	ago-12	6	AB6136AT	-	VW G055025A2
AUDI	A3 (8P1)	1.6; 1.8 TFSI; 1.9 TDI; 2.0 FSI; 2.0 TDI; 2.0 TDI 16V;	mag-03	ago-12	6	AB6025AT + AB6026AT	-	VW G052182
AUDI	A3 (8V1, 8VK)	1.0 TFSI; 1.2 TFSI; 1.4 TFSI; 1.4 TSI; 1.5 TFSI; 1.6 TDI; 1.8 TFSI; 1.8 TFSI quattro; 2.0 TDI; 2.0 TDI quattro; 2.0 TFSI; 2.0 TFSI quattro; S3 quattro	apr-12	ott-20	7	AB6024AT	-	Meccatronica: VW G004000 Cambio: VW G052171
AUDI	A3 (8V1, 8VK)	1.4 TFSI; 1.8 TFSI; 1.8 TFSI quattro; 2.0 TDI; 2.0 TDI quattro	apr-12	ott-20	6	AB6025AT + AB6027AT	-	VW G052182
AUDI	A3 (8V1, 8VK)	1.8 TFSI; 2.0 TDI;	apr-12	ott-20	6	AB6025AT + AB6026AT	-	VW G052182
AUDI	A3 (8V1, 8VK)	S3 quattro	nov-12	ago-16	6	AB6010AT	-	VW G055025A2
AUDI	A3 (8V1, 8VK)	S3 quattro	nov-12	ago-16	8	AB6011AT	-	VW G055540A2
AUDI	A3 Cabriolet (8P7)	1.2 TFSI; 1.6; 1.6 TDI; 1.8 TFSI; 1.9 TDI; 2.0 TDI; 2.0 TFSI	apr-08	mag-13	7	AB6024AT	-	Meccatronica: VW G004000 Cambio: VW G052171
AUDI	A3 Cabriolet (8P7)	1.4 TFSI; 1.8 TFSI; 1.9 TDI; 2.0 TDI; 2.0 TFSI	apr-08	mag-13	6	AB6025AT + AB6027AT	-	VW G052182
AUDI	A3 Cabriolet (8P7)	1.8 TFSI; 2.0 TDI; 2.0 TFSI	apr-08	mag-13	6	AB6025AT + AB6026AT	-	VW G052182
AUDI	A3 Cabriolet (8V7, 8VE)	1.4 TFSI; 1.4 TSI; 1.5 TFSI; 1.6 TDI; 1.8 TFSI; 1.8 TFSI quattro; 2.0 TDI; 2.0 TDI quattro; 2.0 TFSI; 2.0 TFSI quattro; 35 TFSI; 40 TFSI; 40 TFSI quattro; S3 quattro	ott-13	ott-20	7	AB6024AT	-	Meccatronica: VW G004000 Cambio: VW G052171
AUDI	A3 Cabriolet (8V7, 8VE)	1.8 TFSI; 2.0 TDI;	ott-13	ott-20	6	AB6025AT + AB6026AT	-	VW G052182
AUDI	A3 Limousine (8VS, 8VM)	1.0 TFSI; 1.2 TFSI; 1.4 TFSI; 1.4 TSI; 1.5 TFSI; 1.6 TDI; 1.6 TDI quattro; 1.8 TFSI; 1.8 TFSI quattro; 2.0 TDI; 2.0 TDI quattro; 2.0 TFSI; 2.0 TFSI quattro; 30 TDI; 30 TFSI; 35 TDI; 35 TFSI; 40 TDI quattro; 40 TFSI; 40 TFSI quattro; S3 quattro	mag-13	ott-20	7	AB6024AT	-	Meccatronica: VW G004000 Cambio: VW G052171
AUDI	A3 Limousine (8VS, 8VM)	1.8 TFSI; 2.0 TDI;	mag-13	ott-20	6	AB6025AT + AB6026AT	-	VW G052182
AUDI	A3 Sportback (8PA)	1.2 TSI; 1.4 TFSI; 1.6; 1.6 E-Power; 1.6 FSI; 1.6 TDI; 1.8 TFSI; 1.8 TFSI quattro; 1.9 TDI; 2.0 FSI; 2.0 TDI; 2.0 TDI 16V; 2.0 TDI 16V quattro; 2.0 TDI quattro; 2.0 TFSI; 2.0 TFSI quattro; 3.2 V6 quattro; S3 quattro	set-04	mar-13	7	AB6024AT	-	Meccatronica: VW G004000 Cambio: VW G052171

Marca / Brand:	Modello / Model:	Versioni / Version:	Da anno / From:	Ad anno / To:	Marce / Gears:	Codice AB PARTS		Lubrificante Consigliato
AUDI	A3 Sportback (8PA)	1.4 TFSI; 1.8 TFSI; 1.8 TFSI quattro; 1.9 TDI; 2.0 TDI; 2.0 TDI 16V; 2.0 TDI 16V quattro; 2.0 TDI quattro; 2.0 TFSI; 2.0 TFSI quattro; 3.2 V6 quattro; S3 quattro	set-04	mar-13	6	AB6025AT + AB6027AT	-	VW G052182
AUDI	A3 Sportback (8PA)	1.6; 1.6 FSI; 1.8 TFSI; 1.9 TDI; 2.0 FSI; 2.0 TDI; 2.0 TDI 16V; 2.0 TDI 16V quattro; 2.0 TDI quattro; 2.0 TFSI; 2.0 TFSI quattro; 3.2 V6 quattro	set-04	mar-13	6	AB6136AT	-	VW G055025A2
AUDI	A3 Sportback (8PA)	1.6; 1.8 TFSI; 1.9 TDI; 2.0 FSI; 2.0 TDI; 2.0 TDI 16V; 2.0 TDI 16V quattro; 2.0 TDI quattro; 2.0 TFSI; 2.0 TFSI quattro; 3.2 V6 quattro; S3 quattro	set-04	mar-13	6	AB6025AT + AB6026AT	-	VW G052182
AUDI	A3 Sportback (8PA)	RS3 quattro	gen-11	dic-12	7	AB6029AT + AB6031AT *	- AB6032AT *	VW G055529A2
AUDI	A3 Sportback (8PA)	RS3 quattro	gen-11	dic-12	7	AB6029AT + AB6031AT *	- AB6032AT *	VW G055529A2
AUDI	A3 Sportback (8VA, 8VF)	1.0 TFSI; 1.2 TFSI; 1.4 TFSI; 1.4 TFSI e-tron; 1.4 TFSI g-tron; 1.4 TSI; 1.5 TFSI; 1.6 TDI; 1.6 TDI quattro; 1.8 TFSI; 1.8 TFSI quattro; 2.0 TDI; 2.0 TDI quattro; 2.0 TFSI; 2.0 TFSI quattro; 30 g-tron; 30 TDI; 30 TFSI; 35 TDI; 35 TFSI; 40 e-tron; 40 TDI quattro; 40 TFSI; 40 TFSI quattro; S3 quattro	set-12	ott-20	7	AB6024AT	-	Meccatronica: VW G004000 Cambio: VW G052171
AUDI	A3 Sportback (8VA, 8VF)	1.8 TFSI; 1.8 TFSI quattro; 2.0 TDI; 2.0 TDI quattro; 40 TDI quattro; S3 quattro	set-12	ott-20	6	AB6025AT + AB6026AT	-	VW G052182
AUDI	A3 Sportback (8VA, 8VF)	1.8 TFSI; 2.0 TDI; 2.0 TDI quattro	set-12	ott-20	6	AB6025AT + AB6027AT	-	VW G052182
AUDI	A3 Sportback (8VA, 8VF)	RS3 quattro	mar-15	ago-16	7	AB6029AT + AB6031AT *	- AB6032AT *	VW G055529A2
AUDI	A3 Sportback (8VA, 8VF)	RS3 quattro	mar-15	ago-16	7	AB6029AT + AB6031AT *	- AB6032AT *	VW G055529A2
AUDI	A4 Allroad B8 (8KH)	2.0 TDI quattro; 2.0 TFSI quattro; 3.0 TDI quattro	apr-09	mag-16	7	AB6107AT + AB6108AT *	- AB6109AT * AB6110AT *	VW G052529A2 + G055532A2
AUDI	A4 Allroad B8 (8KH)	2.0 TFSI quattro	apr-09	mag-16	8	AB6166AT	-	ZF Lifeguard Fluid 8
AUDI	A4 Allroad B9 (8WH, 8WJ)	2.0 TDI quattro; 2.0 TFSI Mild Hybrid quattro; 2.0 TFSI quattro; 3.0 TDI quattro; 40 TDI Mild Hybrid quattro; 40 TDI quattro; 45 TDI quattro; 45 TFSI Mild Hybrid quattro	gen-16	In produzione	7	AB6102AT + AB6103AT * + AB6105AT *	- AB6104AT * AB6106AT *	VW G055529A2 + G055549A2
AUDI	A4 Allroad B9 (8WH, 8WJ)	2.0 TDI quattro; 2.0 TFSI quattro; 3.0 TDI quattro; 40 TDI quattro; 45 TDI quattro; 50 TDI quattro	gen-16	In produzione	8	AB6168AT	-	ZF Lifeguard Fluid 8
AUDI	A4 Allroad B9 (8WH, 8WJ)	3.0 TDI quattro; 45 TDI quattro; 50 TDI quattro	gen-16	In produzione	8	AB6169AT	-	ZF Lifeguard Fluid 8
AUDI	A4 B5 (8D2)	1.6; 1.8; 1.8 quattro; 1.8 T; 1.8 T quattro; 1.9 TDI; 1.9 TDI quattro; 2.4; 2.4 quattro; 2.5 TDI; 2.5 TDI quattro; 2.6; 2.6 quattro; 2.8; 2.8 quattro; S4 quattro	nov-94	set-01	5	AB6149AT	-	ESSO LT 71141
AUDI	A4 B5 (8D2)	1.6; 1.8; 1.8 quattro; 1.8 T; 1.8 T quattro; 1.9 TDI; 1.9 TDI quattro; 2.4; 2.4 quattro; 2.5 TDI; 2.5 TDI quattro; 2.6; 2.6 quattro; 2.8; 2.8 quattro; S4 quattro	nov-94	set-01	4	AB6135AT	-	VW G052162A2 + 75W90 GI4
AUDI	A4 B5 Avant (8D5)	1.6; 1.8; 1.8 quattro; 1.8 T; 1.8 T quattro; 1.9 Hybrid; 1.9 TDI; 1.9 TDI quattro; 2.4; 2.4 quattro; 2.5 TDI; 2.5 TDI quattro; 2.6; 2.6 quattro; 2.8; 2.8 quattro; RS4 quattro; S4 quattro	nov-94	set-01	5	AB6149AT	-	ESSO LT 71141
AUDI	A4 B5 Avant (8D5)	1.6; 1.8; 1.8 quattro; 1.8 T; 1.8 T quattro; 1.9 Hybrid; 1.9 TDI; 1.9 TDI quattro; 2.4; 2.4 quattro; 2.5 TDI; 2.5 TDI quattro; 2.6; 2.6 quattro; 2.8; 2.8 quattro; RS4 quattro; S4 quattro	nov-94	set-01	4	AB6135AT	-	VW G052162A2 + 75W90 GI4

Marca / Brand:	Modello / Model:	Versioni / Version:	Da anno / From:	Ad anno / To:	Marce / Gears:	Codice AB PARTS		Lubrificante Consigliato
AUDI	A4 B6 (8E2)	1.6; 1.8 T; 1.8 T quattro; 1.9 TDI; 1.9 TDI quattro; 2.0; 2.0 FSI; 2.4; 2.5 TDI; 2.5 TDI quattro; 3.0; 3.0 quattro	nov-00	dic-04	CVT	AB6013AT	-	AUDI G052180A2
AUDI	A4 B6 (8E2)	1.6; 1.8 T; 1.8 T quattro; 1.9 TDI; 1.9 TDI quattro; 2.0; 2.0 FSI; 2.4; 2.5 TDI; 2.5 TDI quattro; 3.0; 3.0 quattro; S4 quattro	nov-00	dic-04	5	AB6149AT	-	ESSO LT 71141
AUDI	A4 B6 (8E2)	1.6; 1.8 T; 1.8 T quattro; 1.9 TDI; 1.9 TDI quattro; 2.0; 2.0 FSI; 2.4; 2.5 TDI; 2.5 TDI quattro; 3.0; 3.0 quattro; S4 quattro	nov-00	dic-04	4	AB6135AT	-	VW G052162A2 + 75W90 GI4
AUDI	A4 B6 (8E2)	1.6; 1.8 T; 1.8 T quattro; 1.9 TDI; 1.9 TDI quattro; 2.0; 2.0 FSI; 2.4; 2.5 TDI; 2.5 TDI quattro; 3.0; 3.0 quattro; S4 quattro	nov-00	dic-04	CVT	AB6012AT	-	AUDI G052180A2
AUDI	A4 B6 (8E2)	S4 quattro	mar-03	dic-04	6	AB6154AT *	AB6155AT *	DEXRON VI
AUDI	A4 B6 (8E2)	S4 quattro	mar-03	dic-04	6	AB6154AT *	AB6155AT *	DEXRON VI
AUDI	A4 B6 Avant (8E5)	1.6; 1.8 T; 1.8 T quattro; 1.9 TDI; 1.9 TDI quattro; 2.0; 2.0 FSI; 2.4; 2.5 TDI; 2.5 TDI quattro; 3.0; 3.0 quattro	apr-01	dic-04	CVT	AB6013AT	-	AUDI G052180A2
AUDI	A4 B6 Avant (8E5)	1.6; 1.8 T; 1.8 T quattro; 1.9 TDI; 1.9 TDI quattro; 2.0; 2.0 FSI; 2.4; 2.5 TDI; 2.5 TDI quattro; 3.0; 3.0 quattro; S4 quattro	apr-01	dic-04	5	AB6149AT	-	ESSO LT 71141
AUDI	A4 B6 Avant (8E5)	1.6; 1.8 T; 1.8 T quattro; 1.9 TDI; 1.9 TDI quattro; 2.0; 2.0 FSI; 2.4; 2.5 TDI; 2.5 TDI quattro; 3.0; 3.0 quattro; S4 quattro	apr-01	dic-04	4	AB6135AT	-	VW G052162A2 + 75W90 GI4
AUDI	A4 B6 Avant (8E5)	1.6; 1.8 T; 1.8 T quattro; 1.9 TDI; 1.9 TDI quattro; 2.0; 2.0 FSI; 2.4; 2.5 TDI; 2.5 TDI quattro; 3.0; 3.0 quattro; S4 quattro	apr-01	dic-04	CVT	AB6012AT	-	AUDI G052180A2
AUDI	A4 B6 Avant (8E5)	S4 quattro	mar-03	dic-04	6	AB6154AT *	AB6155AT *	DEXRON VI
AUDI	A4 B6 Avant (8E5)	S4 quattro	mar-03	dic-04	6	AB6154AT *	AB6155AT *	DEXRON VI
AUDI	A4 B6 Cabriolet (8H7)	1.8 T; 1.8 T quattro; 2.0; 2.0 TDI; 2.0 TFSI 16V; 2.4; 2.5 TDI; 2.7 TDI; 3.0; 3.0 quattro; 3.0 TDI quattro; 3.2 FSI; 3.2 FSI quattro	apr-02	mar-09	CVT	AB6013AT	-	AUDI G052180A2
AUDI	A4 B6 Cabriolet (8H7)	1.8 T; 1.8 T quattro; 2.0; 2.0 TDI; 2.0 TFSI 16V; 2.4; 2.5 TDI; 2.7 TDI; 3.0; 3.0 quattro; 3.0 TDI quattro; 3.2 FSI; 3.2 FSI quattro; RS4 quattro; S4 quattro	apr-02	mar-09	5	AB6149AT	-	ESSO LT 71141
AUDI	A4 B6 Cabriolet (8H7)	1.8 T; 1.8 T quattro; 2.0; 2.0 TDI; 2.0 TFSI 16V; 2.4; 2.5 TDI; 2.7 TDI; 3.0; 3.0 quattro; 3.0 TDI quattro; 3.2 FSI; 3.2 FSI quattro; RS4 quattro; S4 quattro	apr-02	mar-09	4	AB6135AT	-	VW G052162A2 + 75W90 GI4
AUDI	A4 B6 Cabriolet (8H7)	1.8 T; 1.8 T quattro; 2.0; 2.0 TDI; 2.0 TFSI 16V; 2.4; 2.5 TDI; 2.7 TDI; 3.0; 3.0 quattro; 3.0 TDI quattro; 3.2 FSI; 3.2 FSI quattro; RS4 quattro; S4 quattro	apr-02	mar-09	CVT	AB6012AT	-	AUDI G052180A2
AUDI	A4 B6 Cabriolet (8H7)	2.0 TDI; 2.0 TFSI 16V; 3.0 TDI quattro; 3.2 FSI; 3.2 FSI quattro; S4 quattro	mar-04	mar-09	6	AB6154AT *	AB6155AT *	DEXRON VI
AUDI	A4 B6 Cabriolet (8H7)	3.0 TDI quattro; 3.2 FSI quattro; S4 quattro	mar-04	mar-09	6	AB6154AT *	AB6155AT *	DEXRON VI
AUDI	A4 B7 (8EC)	1.6; 1.8 T; 1.8 T quattro; 1.9 TDI; 2.0; 2.0 TDI; 2.0 TDI 16V; 2.0 TDI quattro; 2.0 TFSI; 2.0 TFSI quattro; 2.5 TDI; 2.7 TDI; 3.0 TDI quattro; 3.2 FSI; 3.2 FSI quattro; RS4 quattro; S4 quattro	nov-04	giu-08	5	AB6149AT	-	ESSO LT 71141
AUDI	A4 B7 (8EC)	1.6; 1.8 T; 1.8 T quattro; 1.9 TDI; 2.0; 2.0 TDI; 2.0 TDI 16V; 2.0 TDI quattro; 2.0 TFSI; 2.0 TFSI quattro; 2.5 TDI; 2.7 TDI; 3.0; 3.0 quattro; 3.0 TDI quattro; 3.2 FSI; 3.2 FSI quattro	nov-04	giu-08	CVT	AB6013AT	-	AUDI G052180A2
AUDI	A4 B7 (8EC)	1.6; 1.8 T; 1.8 T quattro; 1.9 TDI; 2.0; 2.0 TDI; 2.0 TDI 16V; 2.0 TDI quattro; 2.0 TFSI; 2.0 TFSI quattro; 2.5 TDI; 2.7 TDI; 3.0; 3.0 quattro; 3.0 TDI quattro; 3.2 FSI; 3.2 FSI quattro; RS4 quattro; S4 quattro	nov-04	giu-08	4	AB6135AT	-	VW G052162A2 + 75W90 GI4
AUDI	A4 B7 (8EC)	2.0 TDI; 2.0 TDI 16V; 2.0 TFSI; 2.0 TFSI quattro; 3.0 TDI quattro; 3.2 FSI; 3.2 FSI quattro; S4 quattro	nov-04	giu-08	6	AB6154AT *	AB6155AT *	DEXRON VI
AUDI	A4 B7 (8EC)	2.0 TFSI quattro; 3.0 TDI quattro; 3.2 FSI quattro; S4 quattro	nov-04	giu-08	6	AB6154AT *	AB6155AT *	DEXRON VI
AUDI	A4 B7 Avant (8ED)	1.6; 1.8 T; 1.8 T quattro; 1.9 TDI; 2.0; 2.0 TDI; 2.0 TDI 16V; 2.0 TDI quattro; 2.0 TFSI; 2.0 TFSI quattro; 2.5 TDI; 2.7 TDI; 3.0 TDI quattro; 3.2 FSI; 3.2 FSI quattro; RS4 quattro; S4 quattro	nov-04	giu-08	5	AB6149AT	-	ESSO LT 71141
AUDI	A4 B7 Avant (8ED)	1.6; 1.8 T; 1.8 T quattro; 1.9 TDI; 2.0; 2.0 TDI; 2.0 TDI 16V; 2.0 TDI quattro; 2.0 TFSI; 2.0 TFSI quattro; 2.5 TDI; 2.7 TDI; 3.0; 3.0 quattro; 3.0 TDI quattro; 3.2 FSI; 3.2 FSI quattro	nov-04	giu-08	CVT	AB6013AT	-	AUDI G052180A2
AUDI	A4 B7 Avant (8ED)	1.6; 1.8 T; 1.8 T quattro; 1.9 TDI; 2.0; 2.0 TDI; 2.0 TDI 16V; 2.0 TDI quattro; 2.0 TFSI; 2.0 TFSI quattro; 2.5 TDI; 2.7 TDI; 3.0; 3.0 quattro; 3.0 TDI quattro; 3.2 FSI; 3.2 FSI quattro; RS4 quattro; S4 quattro	nov-04	giu-08	4	AB6135AT	-	VW G052162A2 + 75W90 GI4

Marca / Brand:	Modello / Model:	Versioni / Version:	Da anno / From:	Ad anno / To:	Marce / Gears:	Codice AB PARTS		Lubrificante Consigliato
AUDI	A4 B7 Avant (8ED)	2.0 TDI; 2.0 TDI 16V; 2.0 TFSI; 2.0 TFSI quattro; 3.0 TDI quattro; 3.2 FSI; 3.2 FSI quattro; S4 quattro	nov-04	giu-08	6	AB6154AT *	AB6155AT *	DEXRON VI
AUDI	A4 B7 Avant (8ED)	2.0 TFSI quattro; 3.0 TDI quattro; 3.2 FSI quattro; S4 quattro	nov-04	giu-08	6	AB6154AT *	AB6155AT *	DEXRON VI
AUDI	A4 B7 Cabriolet (8HE)	1.8 T	gen-06	mar-09	CVT	AB6013AT	-	AUDI G052180A2
AUDI	A4 B7 Cabriolet (8HE)	1.8 T; S4 quattro	nov-05	mar-09	4	AB6135AT	-	VW G052162A2 + 75W90 GL4
AUDI	A4 B7 Cabriolet (8HE)	S4 quattro	nov-05	mar-09	6	AB6154AT *	AB6155AT *	DEXRON VI
AUDI	A4 B7 Cabriolet (8HE)	S4 quattro	nov-05	mar-09	6	AB6154AT *	AB6155AT *	DEXRON VI
AUDI	A4 B8 (8K2)	1.8 TFSI; 1.8 TFSI quattro; 2.0 TDI; 2.0 TDI quattro; 2.0 TFSI; 2.0 TFSI flexible fuel; 2.0 TFSI flexible fuel quattro; 2.0 TFSI quattro; 2.7 TDI; 3.0 TDI; 3.0 TDI quattro; 3.0 TFSI quattro; 3.2 FSI; 3.2 FSI quattro	nov-07	dic-15	CVT	AB6095AT + AB6097AT *	AB6096AT *	VW G052516A2
AUDI	A4 B8 (8K2)	1.8 TFSI; 1.8 TFSI quattro; 2.0 TDI; 2.0 TDI quattro; 2.0 TFSI; 2.0 TFSI flexible fuel; 2.0 TFSI flexible fuel quattro; 2.0 TFSI quattro; 2.7 TDI; 3.0 TDI; 3.0 TDI quattro; 3.0 TFSI quattro; 3.2 FSI; 3.2 FSI quattro	nov-07	dic-15	CVT 8	AB6095AT + AB6097AT *	AB6096AT *	VW G052516A2
AUDI	A4 B8 (8K2)	1.8 TFSI; 1.8 TFSI quattro; 2.0 TDI; 2.0 TDI quattro; 2.0 TFSI; 2.0 TFSI flexible fuel; 2.0 TFSI flexible fuel quattro; 2.0 TFSI quattro; 2.7 TDI; 3.0 TDI; 3.0 TDI quattro; 3.0 TFSI quattro; 3.2 FSI; 3.2 FSI quattro; S4 quattro	nov-07	dic-15	7	AB6107AT + AB6108AT *	AB6109AT * AB6110AT *	VW G052529A2 + G055532A2
AUDI	A4 B8 (8K2)	2.0 TFSI quattro; 3.0 TDI quattro; 3.2 FSI quattro	nov-07	dic-15	6	AB6160AT *	AB6161AT *	ZF Lifeguard Fluid 6
AUDI	A4 B8 (8K2)	2.0 TFSI; 2.0 TFSI flexible fuel; 2.0 TFSI flexible fuel quattro; 2.0 TFSI quattro	giu-08	dic-15	8	AB6166AT	-	ZF Lifeguard Fluid 8
AUDI	A4 B8 Avant (8K5)	1.8 TFSI; 1.8 TFSI quattro; 2.0 TDI; 2.0 TDI quattro; 2.0 TFSI; 2.0 TFSI flexible fuel; 2.0 TFSI flexible fuel quattro; 2.0 TFSI quattro; 2.7 TDI; 3.0 TDI; 3.0 TDI quattro; 3.0 TFSI quattro; 3.2 FSI; 3.2 FSI quattro	nov-07	dic-15	CVT	AB6095AT + AB6097AT *	AB6096AT *	VW G052516A2
AUDI	A4 B8 Avant (8K5)	1.8 TFSI; 1.8 TFSI quattro; 2.0 TDI; 2.0 TDI quattro; 2.0 TFSI; 2.0 TFSI flexible fuel; 2.0 TFSI flexible fuel quattro; 2.0 TFSI quattro; 2.7 TDI; 3.0 TDI; 3.0 TDI quattro; 3.0 TFSI quattro; 3.2 FSI; 3.2 FSI quattro	nov-07	dic-15	CVT 8	AB6095AT + AB6097AT *	AB6096AT *	VW G052516A2
AUDI	A4 B8 Avant (8K5)	1.8 TFSI; 1.8 TFSI quattro; 2.0 TDI; 2.0 TDI quattro; 2.0 TFSI; 2.0 TFSI flexible fuel; 2.0 TFSI flexible fuel quattro; 2.0 TFSI quattro; 2.7 TDI; 3.0 TDI; 3.0 TDI quattro; 3.0 TFSI quattro; 3.2 FSI; 3.2 FSI quattro; RS4 quattro; S4 quattro	nov-07	dic-15	7	AB6107AT + AB6108AT *	AB6109AT * AB6110AT *	VW G052529A2 + G055532A2
AUDI	A4 B8 Avant (8K5)	2.0 TFSI quattro; 3.0 TDI quattro; 3.2 FSI quattro	apr-08	dic-15	6	AB6160AT *	AB6161AT *	ZF Lifeguard Fluid 6
AUDI	A4 B8 Avant (8K5)	2.0 TFSI; 2.0 TFSI flexible fuel; 2.0 TFSI flexible fuel quattro; 2.0 TFSI quattro	giu-08	dic-15	8	AB6166AT	-	ZF Lifeguard Fluid 8
AUDI	A4 B9 (8W2, 8WC)	1.4 TFSI; 2.0 TDI; 2.0 TDI quattro; 2.0 TFSI; 2.0 TFSI Mild Hybrid; 2.0 TFSI Mild Hybrid quattro; 2.0 TFSI quattro; 3.0 TDI; 3.0 TDI quattro; 30 TDI; 30 TDI Mild Hybrid; 35 TDI; 35 TDI Mild Hybrid; 35 TFSI Mild Hybrid; 40 TDI; 40 TDI Mild Hybrid quattro; 40 TDI quattro; 40 TFSI Mild Hybrid; 40 TFSI Mild Hybrid quattro; 45 TDI quattro; 45 TFSI Mild Hybrid; 45 TFSI Mild Hybrid quattro; 50 TDI quattro; S4 quattro	mag-15	In produzione	7	AB6102AT + AB6103AT * + AB6105AT *	AB6104AT * AB6106AT *	VW G055529A2 + G055549A2
AUDI	A4 B9 (8W2, 8WC)	2.0 TDI quattro; 2.0 TFSI quattro; 3.0 TDI quattro; 40 TDI quattro; 45 TDI quattro; 50 TDI quattro; S4 quattro	mag-15	In produzione	8	AB6168AT	-	ZF Lifeguard Fluid 8
AUDI	A4 B9 (8W2, 8WC)	3.0 TDI quattro; 45 TDI quattro; 50 TDI quattro; S4 quattro	mag-15	In produzione	8	AB6169AT	-	ZF Lifeguard Fluid 8
AUDI	A4 B9 Avant (8W5, 8WD)	1.4 TFSI; 2.0 TDI; 2.0 TDI quattro; 2.0 TFSI; 2.0 TFSI g-tron; 2.0 TFSI Mild Hybrid; 2.0 TFSI Mild Hybrid quattro; 2.0 TFSI quattro; 3.0 TDI; 3.0 TDI quattro; 30 TDI; 30 TDI Mild Hybrid; 35 TDI; 35 TDI Mild Hybrid; 35 TFSI Mild Hybrid; 40 TDI; 40 TDI Mild Hybrid quattro; 40 TDI quattro; 40 TFSI g-tron; 40 TFSI Mild Hybrid; 40 TFSI Mild Hybrid quattro; 45 TDI quattro; 45 TFSI Mild Hybrid; 45 TFSI Mild Hybrid quattro; 50 TDI quattro; RS4 quattro; S4 quattro	ago-15	In produzione	7	AB6102AT + AB6103AT * + AB6105AT *	AB6104AT * AB6106AT *	VW G055529A2 + G055549A2
AUDI	A4 B9 Avant (8W5, 8WD)	2.0 TDI quattro; 2.0 TFSI quattro; 3.0 TDI quattro; 40 TDI quattro; 45 TDI quattro; 50 TDI quattro; RS4 quattro; S4 quattro	ago-15	In produzione	8	AB6168AT	-	ZF Lifeguard Fluid 8
AUDI	A4 B9 Avant (8W5, 8WD)	3.0 TDI quattro; 45 TDI quattro; 50 TDI quattro; S4 quattro	ago-15	In produzione	8	AB6169AT	-	ZF Lifeguard Fluid 8

Marca / Brand:	Modello / Model:	Versioni / Version:	Da anno / From:	Ad anno / To:	Marce / Gears:	Codice AB PARTS		Lubrificante Consigliato
AUDI	A5 (8T3)	1.8 TFSI; 2.0 TDI; 2.0 TDI quattro; 2.0 TFSI; 2.0 TFSI quattro; 2.7 TDI; 3.0 TDI; 3.0 TDI quattro; 3.0 TFSI quattro; 3.2 FSI; 3.2 FSI quattro	giu-07	gen-17	CVT	AB6095AT + AB6097AT *	- AB6096AT *	VW G052516A2
AUDI	A5 (8T3)	1.8 TFSI; 2.0 TDI; 2.0 TDI quattro; 2.0 TFSI; 2.0 TFSI quattro; 2.7 TDI; 3.0 TDI; 3.0 TDI quattro; 3.0 TFSI quattro; 3.2 FSI; 3.2 FSI quattro	giu-07	gen-17	CVT 8	AB6095AT + AB6097AT *	- AB6096AT *	VW G052516A2
AUDI	A5 (8T3)	1.8 TFSI; 2.0 TDI; 2.0 TDI quattro; 2.0 TFSI; 2.0 TFSI quattro; 2.7 TDI; 3.0 TDI; 3.0 TDI quattro; 3.0 TFSI quattro; 3.2 FSI; 3.2 FSI quattro; RS5 quattro; S5 quattro	giu-07	gen-17	7	AB6107AT + AB6108AT *	- AB6109AT * AB6110AT *	VW G052529A2 + G055532A2
AUDI	A5 (8T3)	2.0 TFSI quattro; 3.2 FSI; 3.2 FSI quattro; S5 quattro	giu-07	gen-17	6	AB6160AT *	AB6161AT *	ZF Lifeguard Fluid 6
AUDI	A5 (8T3)	2.0 TFSI; 2.0 TFSI quattro	giu-08	gen-17	8	AB6166AT	-	ZF Lifeguard Fluid 8
AUDI	A5 (F53, F5P)	1.4 TFSI; 2.0 TDI; 2.0 TDI quattro; 2.0 TFSI; 2.0 TFSI Mild Hybrid; 2.0 TFSI Mild Hybrid quattro; 2.0 TFSI quattro; 3.0 TDI; 3.0 TDI quattro; 30 TDI Mild Hybrid; 35 TDI; 35 TFSI Mild Hybrid; 40 TDI; 40 TDI Mild Hybrid quattro; 40 TDI quattro; 40 TFSI; 40 TFSI Mild Hybrid; 40 TFSI Mild Hybrid quattro; 45 TDI quattro; 45 TFSI Mild Hybrid; 45 TFSI Mild Hybrid quattro; RS5 quattro; S5 quattro	giu-16	In produzione	7	AB6102AT + AB6103AT * + AB6105AT *	- AB6104AT * AB6106AT *	VW G055529A2 + G055549A2
AUDI	A5 (F53, F5P)	2.0 TDI quattro; 2.0 TFSI quattro; 3.0 TDI quattro; 40 TDI quattro; 45 TDI quattro; 50 TDI quattro; RS5 quattro; S5 quattro	giu-16	In produzione	8	AB6168AT	-	ZF Lifeguard Fluid 8
AUDI	A5 (F53, F5P)	3.0 TDI quattro; 45 TDI quattro; 50 TDI Mild Hybrid quattro; 50 TDI quattro; S5 quattro; S5 TDI Mild Hybrid quattro	lug-16	In produzione	8	AB6169AT	-	ZF Lifeguard Fluid 8
AUDI	A5 Cabriolet (8F7)	1.8 TFSI; 2.0 TDI; 2.0 TDI quattro; 2.0 TFSI; 2.0 TFSI quattro; 2.7 TDI; 3.0 TDI; 3.0 TDI quattro; 3.0 TFSI quattro; 3.2 FSI; 3.2 FSI quattro	mar-09	gen-17	CVT	AB6095AT + AB6097AT *	- AB6096AT *	VW G052516A2
AUDI	A5 Cabriolet (8F7)	1.8 TFSI; 2.0 TDI; 2.0 TDI quattro; 2.0 TFSI; 2.0 TFSI quattro; 2.7 TDI; 3.0 TDI; 3.0 TDI quattro; 3.0 TFSI quattro; 3.2 FSI; 3.2 FSI quattro	mar-09	gen-17	CVT 8	AB6095AT + AB6097AT *	- AB6096AT *	VW G052516A2
AUDI	A5 Cabriolet (8F7)	1.8 TFSI; 2.0 TDI; 2.0 TDI quattro; 2.0 TFSI; 2.0 TFSI quattro; 2.7 TDI; 3.0 TDI; 3.0 TDI quattro; 3.0 TFSI quattro; 3.2 FSI; 3.2 FSI quattro; RS5 quattro; S5 quattro	mar-09	gen-17	7	AB6107AT + AB6108AT *	- AB6109AT * AB6110AT *	VW G052529A2 + G055532A2
AUDI	A5 Cabriolet (8F7)	2.0 TFSI quattro; 3.2 FSI quattro	mar-09	gen-17	6	AB6160AT *	AB6161AT *	ZF Lifeguard Fluid 6
AUDI	A5 Cabriolet (8F7)	2.0 TFSI; 2.0 TFSI quattro	mar-09	gen-17	8	AB6166AT	-	ZF Lifeguard Fluid 8
AUDI	A5 Cabriolet (F57, F5E)	2.0 TDI quattro; 2.0 TFSI Mild Hybrid quattro; 2.0 TFSI quattro; 3.0 TDI quattro; 40 TDI quattro; 45 TFSI Mild Hybrid quattro; 50 TDI quattro; S5 quattro	nov-16	In produzione	8	AB6168AT	-	ZF Lifeguard Fluid 8
AUDI	A5 Cabriolet (F57, F5E)	2.0 TDI; 2.0 TDI quattro; 2.0 TFSI; 2.0 TFSI Mild Hybrid; 2.0 TFSI Mild Hybrid quattro; 2.0 TFSI quattro; 3.0 TDI; 3.0 TDI quattro; 30 TDI MILD HYBRID; 35 TDI; 35 TFSI Mild Hybrid; 40 TDI; 40 TDI Mild Hybrid; 40 TDI Mild Hybrid quattro; 40 TDI quattro; 40 TFSI Mild Hybrid; 40 TFSI Mild Hybrid quattro; 45 TFSI Mild Hybrid; 45 TFSI Mild Hybrid quattro; S5 quattro	nov-16	In produzione	7	AB6102AT + AB6103AT * + AB6105AT *	- AB6104AT * AB6106AT *	VW G055529A2 + G055549A2
AUDI	A5 Cabriolet (F57, F5E)	3.0 TDI quattro; 50 TDI quattro; S5 quattro	nov-16	In produzione	8	AB6169AT	-	ZF Lifeguard Fluid 8
AUDI	A5 Sportback (8TA)	1.8 TFSI; 2.0 TDI; 2.0 TDI quattro; 2.0 TFSI; 2.0 TFSI quattro; 2.7 TDI; 3.0 TDI; 3.0 TDI quattro; 3.0 TFSI quattro; 3.2 FSI quattro	set-09	gen-17	CVT	AB6095AT + AB6097AT *	- AB6096AT *	VW G052516A2
AUDI	A5 Sportback (8TA)	1.8 TFSI; 2.0 TDI; 2.0 TDI quattro; 2.0 TFSI; 2.0 TFSI quattro; 2.7 TDI; 3.0 TDI; 3.0 TDI quattro; 3.0 TFSI quattro; 3.2 FSI quattro	set-09	gen-17	CVT 8	AB6095AT + AB6097AT *	- AB6096AT *	VW G052516A2
AUDI	A5 Sportback (8TA)	1.8 TFSI; 2.0 TDI; 2.0 TDI quattro; 2.0 TFSI; 2.0 TFSI quattro; 2.7 TDI; 3.0 TDI; 3.0 TDI quattro; 3.0 TFSI quattro; 3.2 FSI quattro; S5 quattro	set-09	gen-17	7	AB6107AT + AB6108AT *	- AB6109AT * AB6110AT *	VW G052529A2 + G055532A2
AUDI	A5 Sportback (8TA)	2.0 TFSI quattro; 3.2 FSI quattro	set-09	gen-17	6	AB6160AT *	AB6161AT *	ZF Lifeguard Fluid 6

Marca / Brand:	Modello / Model:	Versioni / Version:	Da anno / From:	Ad anno / To:	Marce / Gears:	Codice AB PARTS		Lubrificante Consigliato
AUDI	A5 Sportback (8TA)	2.0 TFSI; 2.0 TFSI quattro	set-09	gen-17	8	AB6166AT	-	ZF Lifeguard Fluid 8
AUDI	A5 Sportback (F5A, F5F)	1.4 TFSI; 2.0 TDI; 2.0 TDI quattro; 2.0 TFSI; 2.0 TFSI g-tron; 2.0 TFSI Mild Hybrid; 2.0 TFSI Mild Hybrid quattro; 2.0 TFSI quattro; 3.0 TDI; 3.0 TDI quattro; 3.0 TDI Mild Hybrid; 3.5 TDI; 3.5 TFSI Mild Hybrid; 4.0 TDI; 4.0 TDI Mild Hybrid; 4.0 TDI Mild Hybrid quattro; 4.0 TDI quattro; 4.0 TFSI; 4.0 TFSI g-tron; 4.0 TFSI Mild Hybrid; 4.0 TFSI Mild Hybrid quattro; 4.5 TDI quattro; 4.5 TFSI Mild Hybrid; 4.5 TFSI Mild Hybrid quattro; RS5 quattro; S5 quattro	ago-16	In produzione	7	AB6102AT + AB6103AT * + AB6105AT *	AB6104AT * AB6106AT *	VW G05529A2 + G05549A2
AUDI	A5 Sportback (F5A, F5F)	2.0 TDI quattro; 2.0 TFSI quattro; 3.0 TDI quattro; 4.0 TDI quattro; 4.5 TDI quattro; 5.0 TDI quattro; RS5 quattro; S5 quattro	ago-16	In produzione	8	AB6168AT	-	ZF Lifeguard Fluid 8
AUDI	A5 Sportback (F5A, F5F)	3.0 TDI quattro; 4.5 TDI quattro; 5.0 TDI quattro; S5 quattro	set-16	In produzione	8	AB6169AT	-	ZF Lifeguard Fluid 8
AUDI	A6 Allroad C6 (4FH)	2.7 TDI quattro; 3.0 TDI quattro; 3.0 TFSI quattro; 3.2 FSI quattro; 4.2 FSI quattro	mar-06	ago-11	6	AB6154AT *	AB6155AT *	DEXRON VI
AUDI	A6 Allroad C6 (4FH)	2.7 TDI quattro; 3.0 TDI quattro; 3.0 TFSI quattro; 3.2 FSI quattro; 4.2 FSI quattro	mar-06	ago-11	CVT	AB6013AT	-	AUDI G052180A2
AUDI	A6 Allroad C6 (4FH)	2.7 TDI quattro; 3.0 TDI quattro; 3.0 TFSI quattro; 3.2 FSI quattro; 4.2 FSI quattro	mar-06	ago-11	6	AB6154AT *	AB6155AT *	DEXRON VI
AUDI	A6 Allroad C6 (4FH)	2.7 TDI quattro; 3.0 TDI quattro; 3.2 FSI quattro; 4.2 FSI quattro	mar-06	ago-11	5	AB6149AT	-	ESSO LT 71141
AUDI	A6 Allroad C7 (4GH, 4GJ)	3.0 TDI quattro; 3.0 TFSI quattro	gen-12	set-18	8	AB6166AT	-	ZF Lifeguard Fluid 8
AUDI	A6 Allroad C7 (4GH, 4GJ)	3.0 TDI quattro; 3.0 TFSI quattro	gen-12	set-18	7	AB6107AT + AB6108AT *	AB6109AT * AB6110AT *	VW G052529A2 + G05532A2
AUDI	A6 Allroad C8 (4AH)	5.0 TDI Mild Hybrid quattro; 5.5 TDI Mild Hybrid quattro	nov-18	In produzione	8	AB6169AT	-	ZF Lifeguard Fluid 8
AUDI	A6 C4 (4A2)	1.8; 1.8 quattro	dic-95	ott-97	CVT	AB6013AT	-	AUDI G052180A2
AUDI	A6 C4 (4A2)	1.8; 1.8 quattro; 1.9 TDI; 2.0; 2.0 16V; 2.0 16V quattro; 2.3; 2.3 quattro; 2.5 TDI; 2.5 TDI quattro; 2.6; 2.6 quattro; 2.8; 2.8 quattro	giu-94	ott-97	4	AB6141AT + AB6142AT	-	Total Fluide AT42
AUDI	A6 C4 (4A2)	1.8; 1.8 quattro; 1.9 TDI; 2.0; 2.0 16V; 2.0 16V quattro; 2.3; 2.3 quattro; 2.5 TDI; 2.5 TDI quattro; 2.6; 2.6 quattro; 2.8; 2.8 quattro; S6 4.2 quattro; S6 Plus quattro; S6 Turbo quattro	giu-94	ott-97	4	AB6135AT	-	VW G052162A2 + 75W90 G14
AUDI	A6 C4 (4A2)	1.8; 1.9 TDI; 2.0; 2.0 16V; 2.0 16V quattro; 2.3; 2.3 quattro; 2.5 TDI; 2.6; 2.6 quattro; 2.8; 2.8 quattro; S6 4.2 quattro	giu-94	ott-97	4	AB6132AT *	AB6133AT *	VW G052162A2 + 75W90 G14
AUDI	A6 C4 (4A2)	1.8; 1.9 TDI; 2.0; 2.0 16V; 2.3; 2.5 TDI; 2.6; 2.8	giu-94	ott-97	5	AB6149AT	-	ESSO LT 71141
AUDI	A6 C4 (4A2)	S6 4.2 quattro	giu-94	ott-97	4	AB6147AT	-	DEXRON III
AUDI	A6 C4 Avant (4A5)	1.8; 1.8 quattro	dic-95	dic-97	CVT	AB6013AT	-	AUDI G052180A2
AUDI	A6 C4 Avant (4A5)	1.8; 1.8 quattro; 1.9 TDI; 2.0; 2.0 16V; 2.0 16V quattro; 2.3; 2.3 quattro; 2.5 TDI; 2.5 TDI quattro; 2.6; 2.6 quattro; 2.8; 2.8 quattro	giu-94	dic-97	4	AB6141AT + AB6142AT	-	Total Fluide AT42
AUDI	A6 C4 Avant (4A5)	1.8; 1.8 quattro; 1.9 TDI; 2.0; 2.0 16V; 2.0 16V quattro; 2.3; 2.3 quattro; 2.5 TDI; 2.5 TDI quattro; 2.6; 2.6 quattro; 2.8; 2.8 quattro; S6 4.2 quattro; S6 Plus quattro; S6 Turbo quattro	giu-94	dic-97	4	AB6135AT	-	VW G052162A2 + 75W90 G14
AUDI	A6 C4 Avant (4A5)	1.8; 1.9 TDI; 2.0; 2.0 16V; 2.0 16V quattro; 2.3; 2.3 quattro; 2.5 TDI; 2.6; 2.6 quattro; 2.8; 2.8 quattro	giu-94	dic-97	4	AB6132AT *	AB6133AT *	VW G052162A2 + 75W90 G14
AUDI	A6 C4 Avant (4A5)	S6 4.2 quattro	giu-94	dic-97	4	AB6147AT	-	DEXRON III
AUDI	A6 C5 (4B2)	1.8; 1.8 T; 1.8 T quattro; 1.9 TDI; 2.0; 2.4; 2.4 quattro; 2.5 TDI; 2.5 TDI quattro; 2.7 quattro; 2.7 T; 2.7 T quattro; 2.8; 2.8 quattro; 3.0; 3.0 quattro; 3.7; 3.7 quattro; 4.2 quattro	gen-97	gen-05	CVT	AB6013AT	-	AUDI G052180A2
AUDI	A6 C5 (4B2)	1.8; 1.8 T; 1.8 T quattro; 1.9 TDI; 2.0; 2.4; 2.4 quattro; 2.5 TDI; 2.5 TDI quattro; 2.7 quattro; 2.7 T; 2.7 T quattro; 2.8; 2.8 quattro; 3.0; 3.0 quattro; 3.7; 3.7 quattro; 4.2 quattro; RS6 quattro; S6 quattro	gen-97	gen-05	CVT	AB6012AT	-	AUDI G052180A2

Marca / Brand:	Modello / Model:	Versioni / Version:	Da anno / From:	Ad anno / To:	Marce / Gears:	Codice AB PARTS		Lubrificante Consigliato
AUDI	A6 C5 (4B2)	1.8; 1.8 T; 1.8 T quattro; 1.9 TDI; 2.0; 2.4; 2.4 quattro; 2.5 TDI; 2.5 TDI quattro; 2.7 T; 2.7 T quattro; 2.8; 2.8 quattro; 3.0; 3.0 quattro; 3.7; 3.7 quattro; 4.2 quattro; RS6 quattro; S6 quattro	gen-97	gen-05	4	AB6135AT	-	VW G052162A2 + 75W90 GI4
AUDI	A6 C5 (4B2)	1.8; 1.8 T; 1.9 TDI; 2.0; 2.4; 2.4 quattro; 2.5 TDI; 2.5 TDI quattro; 2.7 T; 2.7 T quattro; 2.8; 3.0; 3.0 quattro; 3.7; 3.7 quattro; 4.2 quattro; RS6 quattro; S6 quattro	gen-97	gen-05	5	AB6149AT	-	ESSO LT 71141
AUDI	A6 C5 Avant (4B5)	1.8; 1.8 T; 1.8 T quattro; 1.9 TDI; 2.0; 2.4; 2.4 quattro; 2.5 TDI; 2.5 TDI quattro; 2.7 T; 2.7 T quattro; 2.8; 2.8 quattro; 3.0; 3.0 quattro; 3.7; 3.7 quattro; 4.2 quattro	dic-97	gen-05	CVT	AB6013AT	-	AUDI G052180A2
AUDI	A6 C5 Avant (4B5)	1.8; 1.8 T; 1.8 T quattro; 1.9 TDI; 2.0; 2.4; 2.4 quattro; 2.5 TDI; 2.5 TDI quattro; 2.7 T; 2.7 T quattro; 2.8; 2.8 quattro; 3.0; 3.0 quattro; 3.7; 3.7 quattro; 4.2 quattro; RS6 plus quattro; RS6 quattro; S6 quattro	dic-97	gen-05	4	AB6135AT	-	VW G052162A2 + 75W90 GI4
AUDI	A6 C5 Avant (4B5)	1.8; 1.8 T; 1.8 T quattro; 1.9 TDI; 2.0; 2.4; 2.4 quattro; 2.5 TDI; 2.5 TDI quattro; 2.7 T; 2.7 T quattro; 2.8; 2.8 quattro; 3.0; 3.0 quattro; 3.7; 3.7 quattro; 4.2 quattro; RS6 plus quattro; RS6 quattro; S6 quattro	dic-97	gen-05	CVT	AB6012AT	-	AUDI G052180A2
AUDI	A6 C5 Avant (4B5)	3.0; 3.0 quattro	giu-01	gen-05	6	AB6154AT *	AB6155AT *	DEXRON VI
AUDI	A6 C5 Avant (4B5)	RS6 plus quattro; RS6 quattro	lug-02	gen-05	5	AB6149AT	-	ESSO LT 71141
AUDI	A6 C6 (4F2)	2.0 TDI; 2.0 TFSI; 2.4; 2.4 quattro; 2.7 TDI; 2.7 TDI quattro; 2.8 FSI; 2.8 FSI quattro; 3.0; 3.0 quattro; 3.0 TDI quattro; 3.0 TFSI quattro; 3.2 FSI; 3.2 FSI quattro; 4.2 FSI quattro; 4.2 quattro; RS6 quattro; S6 quattro	mag-04	mar-11	CVT	AB6013AT	-	AUDI G052180A2
AUDI	A6 C6 (4F2)	2.0 TDI; 2.0 TFSI; 2.4; 2.4 quattro; 2.7 TDI; 2.7 TDI quattro; 3.0 quattro; 3.0 TDI quattro; 3.2 FSI; 3.2 FSI quattro; 4.2 quattro	mag-04	mar-11	5	AB6149AT	-	ESSO LT 71141
AUDI	A6 C6 (4F2)	2.7 TDI quattro; 2.8 FSI quattro; 3.0 quattro; 3.0 TDI quattro; 3.0 TFSI quattro; 3.2 FSI quattro; 4.2 FSI quattro; 4.2 quattro	mag-04	mar-11	6	AB6154AT *	AB6155AT *	DEXRON VI
AUDI	A6 C6 (4F2)	2.7 TDI; 2.7 TDI quattro; 2.8 FSI; 2.8 FSI quattro; 3.0; 3.0 quattro; 3.0 TDI quattro; 3.0 TFSI quattro; 3.2 FSI; 3.2 FSI quattro; 4.2 FSI quattro; 4.2 quattro; S6 quattro	mag-04	mar-11	6	AB6154AT *	AB6155AT *	DEXRON VI
AUDI	A6 C6 (4F2)	RS6 quattro	set-08	ago-10	6	AB6160AT *	AB6161AT *	ZF Lifeguard Fluid 6
AUDI	A6 C6 (4F2)	S6 quattro	mar-06	mar-11	6	AB6158AT *	AB6159AT *	VW G055005A2 (benzina) VW G055162A2 (diesel)
AUDI	A6 C6 Avant (4F5)	2.0 TDI; 2.0 TFSI; 2.4; 2.4 quattro; 2.7 TDI; 2.7 TDI quattro; 2.8 FSI; 2.8 FSI quattro; 3.0; 3.0 quattro; 3.0 TDI quattro; 3.0 TFSI quattro; 3.2 FSI; 3.2 FSI quattro; 4.2 FSI quattro; 4.2 quattro; RS6 quattro; S6 quattro	nov-04	ago-11	CVT	AB6013AT	-	AUDI G052180A2
AUDI	A6 C6 Avant (4F5)	2.0 TDI; 2.0 TFSI; 2.4; 2.4 quattro; 2.7 TDI; 2.7 TDI quattro; 3.0 quattro; 3.0 TDI quattro; 3.2 FSI; 3.2 FSI quattro; 4.2 quattro	nov-04	ago-11	5	AB6149AT	-	ESSO LT 71141
AUDI	A6 C6 Avant (4F5)	2.7 TDI quattro; 2.8 FSI quattro; 3.0 quattro; 3.0 TDI quattro; 3.0 TFSI quattro; 3.2 FSI quattro; 4.2 FSI quattro; 4.2 quattro	nov-04	ago-11	6	AB6154AT *	AB6155AT *	DEXRON VI
AUDI	A6 C6 Avant (4F5)	2.7 TDI; 2.7 TDI quattro; 2.8 FSI; 2.8 FSI quattro; 3.0; 3.0 quattro; 3.0 TDI quattro; 3.0 TFSI quattro; 3.2 FSI; 3.2 FSI quattro; 4.2 FSI quattro; 4.2 quattro; S6 quattro	nov-04	ago-11	6	AB6154AT *	AB6155AT *	DEXRON VI
AUDI	A6 C6 Avant (4F5)	RS6 quattro	apr-08	ago-10	6	AB6160AT *	AB6161AT *	ZF Lifeguard Fluid 6
AUDI	A6 C6 Avant (4F5)	S6 quattro	mar-06	ago-11	6	AB6158AT *	AB6159AT *	VW G055005A2 (benzina) VW G055162A2 (diesel)
AUDI	A6 C7 (4G2, 4GC)	1.8 TFSI; 2.0 TDI; 2.0 TDI quattro; 2.0 TFSI; 2.0 TFSI Hybrid; 2.0 TFSI quattro; 2.8 FSI; 2.8 FSI quattro; 3.0 TDI; 3.0 TDI quattro; 3.0 TFSI quattro; S6 quattro	nov-10	set-18	7	AB6107AT + AB6108AT *	- AB6109AT * AB6110AT *	VW G052529A2 + G055532A2

Marca / Brand:	Modello / Model:	Versioni / Version:	Da anno / From:	Ad anno / To:	Marce / Gears:	Codice AB PARTS		Lubrificante Consigliato
AUDI	A6 C7 (4G2, 4GC)	1.8 TFSI; 2.0 TDI; 2.0 TDI quattro; 2.0 TFSI; 2.0 TFSI Hybrid; 2.0 TFSI quattro; 2.8 FSI; 2.8 FSI quattro; 3.0 TDI; 3.0 TDI quattro; 3.0 TFSI quattro; S6 quattro	nov-10	set-18	7	AB6102AT + AB6103AT * + AB6105AT *	- AB6104AT * AB6106AT *	VW G055529A2 + G055549A2
AUDI	A6 C7 (4G2, 4GC)	2.0 TDI; 2.0 TFSI; 2.0 TFSI Hybrid; 2.0 TFSI quattro; 2.8 FSI; 2.8 FSI quattro; 3.0 TDI; 3.0 TDI quattro; 3.0 TFSI quattro	nov-10	set-18	CVT	AB6095AT + AB6097AT *	- AB6096AT *	VW G052516A2
AUDI	A6 C7 (4G2, 4GC)	2.0 TDI; 2.0 TFSI; 2.0 TFSI Hybrid; 2.0 TFSI quattro; 2.8 FSI; 2.8 FSI quattro; 3.0 TDI; 3.0 TDI quattro; 3.0 TFSI quattro	nov-10	set-18	CVT 8	AB6095AT + AB6097AT *	- AB6096AT *	VW G052516A2
AUDI	A6 C7 (4G2, 4GC)	2.0 TFSI Hybrid	nov-11	apr-15	8	AB6167AT	-	ZF Lifeguard Fluid 8
AUDI	A6 C7 (4G2, 4GC)	2.0 TFSI; 2.0 TFSI Hybrid; 2.0 TFSI quattro; 3.0 TDI; 3.0 TDI quattro; 3.0 TFSI quattro	nov-10	set-18	8	AB6166AT	-	ZF Lifeguard Fluid 8
AUDI	A6 C7 Avant (4G5, 4GD)	1.8 TFSI; 2.0 TDI; 2.0 TDI quattro; 2.0 TFSI; 2.0 TFSI quattro; 2.8 FSI; 2.8 FSI quattro; 3.0 TDI; 3.0 TDI quattro; 3.0 TFSI quattro; RS6 performance quattro; RS6 quattro; S6 quattro	mag-11	set-18	7	AB6107AT + AB6108AT *	- AB6109AT * AB6110AT *	VW G055529A2 + G055532A2
AUDI	A6 C7 Avant (4G5, 4GD)	1.8 TFSI; 2.0 TDI; 2.0 TDI quattro; 2.0 TFSI; 2.0 TFSI quattro; 2.8 FSI; 2.8 FSI quattro; 3.0 TDI; 3.0 TDI quattro; 3.0 TFSI quattro; RS6 performance quattro; RS6 quattro; S6 quattro	mag-11	set-18	7	AB6102AT + AB6103AT * + AB6105AT *	- AB6104AT * AB6106AT *	VW G055529A2 + G055549A2
AUDI	A6 C7 Avant (4G5, 4GD)	2.0 TDI; 2.0 TFSI; 2.8 FSI; 2.8 FSI quattro; 3.0 TDI; 3.0 TDI quattro; 3.0 TFSI quattro	mag-11	set-18	CVT	AB6095AT + AB6097AT *	- AB6096AT *	VW G052516A2
AUDI	A6 C7 Avant (4G5, 4GD)	2.0 TDI; 2.0 TFSI; 2.8 FSI; 2.8 FSI quattro; 3.0 TDI; 3.0 TDI quattro; 3.0 TFSI quattro	mag-11	set-18	CVT 8	AB6095AT + AB6097AT *	- AB6096AT *	VW G052516A2
AUDI	A6 C7 Avant (4G5, 4GD)	2.0 TFSI; 2.0 TFSI quattro; 3.0 TDI; 3.0 TDI quattro; 3.0 TFSI quattro; RS6 performance quattro; RS6 quattro	mag-11	set-18	8	AB6166AT	-	ZF Lifeguard Fluid 8
AUDI	A6 C8 (4A2)	30 TDI Mild Hybrid; 35 TDI Mild Hybrid; 40 TDI; 40 TDI Mild Hybrid; 40 TDI Mild Hybrid quattro; 40 TFSI; 45 TDI Mild Hybrid quattro; 45 TDI quattro; 45 TDI Mild Hybrid quattro; 45 TFSI Mild Hybrid; 45 TFSI Mild Hybrid quattro; 50 TDI Mild Hybrid quattro; 50 TFSI e quattro; 55 TFSI e quattro; 55 TFSI Mild Hybrid quattro	feb-18	In produzione	7	AB6102AT + AB6103AT * + AB6105AT *	- AB6104AT * AB6106AT *	VW G055529A2 + G055549A2
AUDI	A6 C8 (4A2)	45 TDI Mild Hybrid quattro; 45 TDI quattro; 50 TDI Mild Hybrid quattro; S6 TDI Mild Hybrid quattro	feb-18	In produzione	8	AB6169AT	-	ZF Lifeguard Fluid 8
AUDI	A6 C8 (4A2)	45 TDI quattro	lug-19	In produzione	8	AB6168AT	-	ZF Lifeguard Fluid 8
AUDI	A6 C8 Avant (4A5)	30 TDI Mild Hybrid; 35 TDI Mild Hybrid; 40 TDI Mild Hybrid; 40 TDI Mild Hybrid quattro; 40 TFSI; 45 TDI Mild Hybrid quattro; 45 TDI quattro; 45 TFSI Mild Hybrid; 45 TFSI Mild Hybrid quattro; 50 TDI Mild Hybrid quattro; 50 TFSI e quattro; 55 TFSI e quattro; 55 TFSI Mild Hybrid quattro; RS6 Mild Hybrid quattro	mag-18	In produzione	7	AB6102AT + AB6103AT * + AB6105AT *	- AB6104AT * AB6106AT *	VW G055529A2 + G055549A2
AUDI	A6 C8 Avant (4A5)	45 TDI Mild Hybrid quattro; 45 TDI quattro; 50 TDI Mild Hybrid quattro; S6 TDI Mild Hybrid quattro	mag-18	In produzione	8	AB6169AT	-	ZF Lifeguard Fluid 8
AUDI	A6 C8 Avant (4A5)	45 TDI quattro	lug-19	In produzione	8	AB6168AT	-	ZF Lifeguard Fluid 8
AUDI	A6 C8 Avant (4A5)	RS6 Mild Hybrid quattro	set-19	In produzione	8	AB6175AT	-	ZF Lifeguard Fluid 8
AUDI	A7 Sportback (4GA, 4GF)	1.8 TFSI; 2.0 TFSI; 2.0 TFSI quattro; 2.8 FSI; 2.8 FSI quattro; 3.0 TDI; 3.0 TDI quattro; 3.0 TFSI quattro; RS7 performance quattro; RS7 quattro	ott-10	mag-18	8	AB6166AT	-	ZF Lifeguard Fluid 8
AUDI	A7 Sportback (4GA, 4GF)	1.8 TFSI; 2.0 TFSI; 2.0 TFSI quattro; 2.8 FSI; 2.8 FSI quattro; 3.0 TDI; 3.0 TDI quattro; 3.0 TFSI quattro; RS7 performance quattro; RS7 quattro; S7 quattro	ott-10	mag-18	7	AB6107AT + AB6108AT *	- AB6109AT * AB6110AT *	VW G055529A2 + G055532A2

Marca / Brand:	Modello / Model:	Versioni / Version:	Da anno / From:	Ad anno / To:	Marce / Gears:	Codice AB PARTS		Lubrificante Consigliato
AUDI	A7 Sportback (4GA, 4GF)	1.8 TFSI; 2.0 TFSI; 2.0 TFSI quattro; 2.8 FSI; 2.8 FSI quattro; 3.0 TDI; 3.0 TDI quattro; 3.0 TFSI quattro; S7 quattro	ott-10	mag-18	7	AB6102AT + AB6103AT * + AB6105AT *	- AB6104AT * AB6106AT *	VW G055529A2 + G055549A2
AUDI	A7 Sportback (4GA, 4GF)	2.8 FSI; 2.8 FSI quattro; 3.0 TDI; 3.0 TDI quattro; 3.0 TFSI quattro	ott-10	giu-17	CVT	AB6095AT + AB6097AT *	- AB6096AT *	VW G052516A2
AUDI	A7 Sportback (4GA, 4GF)	2.8 FSI; 2.8 FSI quattro; 3.0 TDI; 3.0 TDI quattro; 3.0 TFSI quattro	ott-10	giu-17	CVT 8	AB6095AT + AB6097AT *	- AB6096AT *	VW G052516A2
AUDI	A7 Sportback (4KA)	40 TDI Mild Hybrid; 40 TDI Mild Hybrid quattro; 40 TFSI Mild Hybrid; 45 TDI Mild Hybrid quattro; 45 TFSI Mild Hybrid; 45 TFSI Mild Hybrid quattro; 50 TDI Mild Hybrid quattro; 50 TFSI e quattro; 55 TFSI e quattro; 55 TFSI Mild Hybrid quattro	ott-17	In produzione	7	AB6102AT + AB6103AT * + AB6105AT *	- AB6104AT * AB6106AT *	VW G055529A2 + G055549A2
AUDI	A7 Sportback (4KA)	45 TDI Mild Hybrid quattro; 50 TDI Mild Hybrid quattro; RS7 Mild Hybrid quattro; S7 TDI Mild Hybrid quattro	ott-17	In produzione	8	AB6175AT	-	ZF Lifeguard Fluid 8
AUDI	A7 Sportback (4KA)	45 TDI quattro	set-19	In produzione	8	AB6169AT	-	ZF Lifeguard Fluid 8
AUDI	A8 D2 (4D2, 4D8)	2.5 TDI; 2.5 TDI quattro; 2.8; 2.8 quattro; 3.3 TDI quattro; 3.7; 3.7 quattro; 4.2 quattro; 6.0 W12 quattro; S8 quattro	mar-94	set-02	5	AB6149AT	-	ESSO LT 71141
AUDI	A8 D2 (4D2, 4D8)	2.5 TDI; 2.5 TDI quattro; 2.8; 2.8 quattro; 3.7; 3.7 quattro; 4.2 quattro	mar-94	set-02	4	AB6141AT + AB6142AT	-	Total Fluide AT42
AUDI	A8 D2 (4D2, 4D8)	2.8; 2.8 quattro; 4.2 quattro	mar-94	nov-98	4	AB6147AT	-	DEXRON III
AUDI	A8 D3 (4E2, 4E8)	2.8 FSI; 3.0; 3.0 quattro; 3.0 TDI quattro; 3.2 FSI; 3.2 FSI quattro; 3.7 quattro; 4.0 TDI quattro; 4.2 FSI quattro; 4.2 quattro; 4.2 TDI quattro; 6.0 W12 quattro	ott-02	lug-10	CVT	AB6013AT	-	AUDI G052180A2
AUDI	A8 D3 (4E2, 4E8)	2.8 FSI; 3.0; 3.0 quattro; 3.0 TDI quattro; 3.2 FSI; 3.2 FSI quattro; 3.7 quattro; 4.0 TDI quattro; 4.2 FSI quattro; 4.2 quattro; 4.2 TDI quattro; 6.0 W12 quattro; S8 quattro	ott-02	lug-10	6	AB6154AT *	AB6155AT *	DEXRON VI
AUDI	A8 D3 (4E2, 4E8)	2.8 FSI; 3.0; 3.0 TDI quattro; 3.2 FSI; 3.2 FSI quattro; 3.7 quattro; 4.0 TDI quattro; 4.2 FSI quattro; 4.2 quattro; 4.2 TDI quattro; 6.0 W12 quattro; S8 quattro	ott-02	lug-10	CVT	AB6012AT	-	AUDI G052180A2
AUDI	A8 D3 (4E2, 4E8)	3.0 TDI quattro; 3.2 FSI quattro; 4.2 FSI quattro; 4.2 quattro; 4.2 TDI quattro	ott-02	lug-10	6	AB6154AT *	AB6155AT *	DEXRON VI
AUDI	A8 D3 (4E2, 4E8)	3.0 TDI quattro; 3.2 FSI; 3.2 FSI quattro; 3.7 quattro; 4.0 TDI quattro; 4.2 FSI quattro; 4.2 quattro; 4.2 TDI quattro; 6.0 W12 quattro; S8 quattro	ott-02	lug-10	6	AB6158AT *	AB6159AT *	VW G055005A2 (benzina) VW G055162A2 (diesel)
AUDI	A8 D3 (4E2, 4E8)	3.0; 3.0 TDI quattro; 3.7 quattro; 4.0 TDI quattro; 4.2 quattro; 6.0 W12 quattro	ott-02	lug-10	5	AB6149AT	-	ESSO LT 71141
AUDI	A8 D4 (4H2, 4H8, 4HC, 4HL)	2.0 TFSI hybrid	feb-12	nov-15	8	AB6167AT	-	ZF Lifeguard Fluid 8
AUDI	A8 D4 (4H2, 4H8, 4HC, 4HL)	2.0 TFSI hybrid; 2.0 TFSI quattro; 2.5 TFSI; 3.0 TDI; 3.0 TDI quattro; 3.0 TFSI quattro; 4.0 TFSI quattro; 4.2 FSI quattro; 4.2 TDI quattro; 6.3 W12 quattro; S8 plus quattro; S8 quattro	nov-09	gen-18	8	AB6166AT	-	ZF Lifeguard Fluid 8
AUDI	A8 D5 (4N2, 4N8, 4NC, 4NL)	45 TDI quattro	gen-19	In produzione	8	AB6168AT	-	ZF Lifeguard Fluid 8
AUDI	A8 D5 (4N2, 4N8, 4NC, 4NL)	45 TDI quattro	gen-19	In produzione	8	AB6169AT	-	ZF Lifeguard Fluid 8
AUDI	A8 D5 (4N2, 4N8, 4NC, 4NL)	60 TDI Mild Hybrid quattro; 60 TFSI Mild Hybrid quattro; S8 Mild Hybrid quattro	mag-18	In produzione	8	AB6175AT	-	ZF Lifeguard Fluid 8
AUDI	ALLROAD C5 (4BH)	2.5 TDI quattro	mag-03	ago-05	CVT	AB6013AT	-	AUDI G052180A2
AUDI	ALLROAD C5 (4BH)	2.5 TDI quattro; 2.7 T quattro; 4.2 V8 quattro	mag-00	ago-05	5	AB6149AT	-	ESSO LT 71141
AUDI	CABRIOLET B3 (8G7)	1.8; 1.9 TDI; 2.0 16V; 2.0 E; 2.3 E; 2.6; 2.8	mag-91	ago-00	4	AB6135AT	-	VW G052162A2 + 75W90 GL4
AUDI	CABRIOLET B3 (8G7)	1.8; 1.9 TDI; 2.0 16V; 2.0 E; 2.3 E; 2.6; 2.8	mag-91	ago-00	4	AB6132AT *	AB6133AT *	VW G052162A2 + 75W90 GL4

Marca / Brand:	Modello / Model:	Versioni / Version:	Da anno / From:	Ad anno / To:	Marce / Gears:	Codice AB PARTS		Lubrificante Consigliato
AUDI	COUPE B3 (89, 8B3)	1.8; 2.0; 2.0 16 V; 2.0 20 V; 2.0 20 V quattro; 2.2 quattro; 2.3; 2.3 20V; 2.3 20V quattro; 2.3 quattro; 2.6; 2.6 quattro; 2.8; 2.8 quattro	ott-88	dic-96	4	AB6132AT *	AB6133AT *	VW G052162A2 + 75W90 Gl4
AUDI	COUPE B3 (89, 8B3)	2.0 20 V	ago-89	lug-91	4	AB6135AT	-	VW G052162A2 + 75W90 Gl4
AUDI	Q2 (GAB, GAG)	1.0 TFSI; 1.4 TFSI; 1.6 TDI; 2.0 TDI; 2.0 TDI quattro; 2.0 TFSI quattro; 30 TFSI; 35 TDI; 35 TDI quattro	giu-16	In produzione	7	AB6024AT	-	Meccatronica: VW G004000 Cambio: VW G052171
AUDI	Q3 (8UB, 8UG)	1.4 TSI	ott-13	ott-18	6	AB6025AT + AB6026AT	-	VW G052182
AUDI	Q3 (8UB, 8UG)	2.0 TDI; 2.0 TDI quattro; 2.0 TFSI; 2.0 TFSI quattro; RS 2.5 quattro	mag-11	ott-18	7	AB6029AT + AB6031AT *	AB6032AT *	VW G055529A2
AUDI	Q3 (8UB, 8UG)	2.0 TDI; 2.0 TDI quattro; 2.0 TFSI; 2.0 TFSI quattro; RS 2.5 quattro	mag-11	ott-18	7	AB6029AT + AB6031AT *	AB6032AT *	VW G055529A2
AUDI	Q3 (8UB, 8UG)	2.0 TFSI quattro	set-14	ott-18	6	AB6008AT	-	VW G055025A2
AUDI	Q3 (F3B)	40 TFSI quattro; 45 TFSI quattro	lug-18	In produzione	7	AB6002AT	-	VW G055540A2
AUDI	Q5 (8RB)	2.0 TDI; 2.0 TDI quattro; 2.0 TFSI Hybrid quattro; 2.0 TFSI quattro	nov-08	mag-17	7	AB6102AT + AB6103AT * + AB6105AT *	AB6104AT * AB6106AT *	VW G055529A2 + G055549A2
AUDI	Q5 (8RB)	2.0 TDI; 2.0 TDI quattro; 2.0 TFSI Hybrid quattro; 2.0 TFSI quattro; 3.0 TDI quattro; 3.0 TFSI quattro; 3.2 FSI quattro; SQ5 TDI quattro; SQ5 TFSI quattro	nov-08	mag-17	6	AB6160AT *	AB6161AT *	ZF Lifeguard Fluid 6
AUDI	Q5 (8RB)	2.0 TDI; 2.0 TDI quattro; 2.0 TFSI Hybrid quattro; 2.0 TFSI quattro; 3.0 TDI quattro; 3.0 TFSI quattro; 3.2 FSI quattro; SQ5 TDI quattro; SQ5 TFSI quattro	nov-08	mag-17	8	AB6166AT	-	ZF Lifeguard Fluid 8
AUDI	Q5 (8RB)	2.0 TDI; 2.0 TDI quattro; 2.0 TFSI Hybrid quattro; 2.0 TFSI quattro; 3.0 TDI quattro; 3.0 TFSI quattro; 3.2 FSI quattro; SQ5 TDI quattro; SQ5 TFSI quattro	nov-08	mag-17	7	AB6107AT + AB6108AT *	AB6109AT * AB6110AT *	VW G052529A2 + G055532A2
AUDI	Q5 (8RB)	2.0 TFSI Hybrid quattro	giu-11	giu-16	8	AB6167AT	-	ZF Lifeguard Fluid 8
AUDI	Q5 (FYB, FYG)	2.0 TDI quattro; 2.0 TFSI quattro; 3.0 TDI quattro; 35 TDI quattro; 40 TDI quattro; 45 TDI quattro; 50 TDI quattro	giu-16	In produzione	8	AB6168AT	-	ZF Lifeguard Fluid 8
AUDI	Q5 (FYB, FYG)	2.0 TDI; 2.0 TDI quattro; 2.0 TFSI quattro; 30 TDI Mild Hybrid; 35 TDI; 35 TDI Mild Hybrid; 35 TDI quattro; 40 TDI Mild Hybrid quattro; 40 TDI quattro; 40 TFSI Mild Hybrid quattro; 45 TDI quattro; 45 TFSI Mild Hybrid quattro; 50 TFSI e quattro; 55 TFSI e quattro	giu-16	In produzione	7	AB6102AT + AB6103AT * + AB6105AT *	AB6104AT * AB6106AT *	VW G055529A2 + G055549A2
AUDI	Q5 (FYB, FYG)	SQ5 TFSI quattro	nov-16	In produzione	8	AB6169AT	-	ZF Lifeguard Fluid 8
AUDI	Q5 Sportback (FYT)	35 TDI Mild Hybrid; 40 TDI Mild Hybrid quattro; 40 TFSI Mild Hybrid quattro; 45 TFSI Mild Hybrid quattro; 50 TFSI e quattro; 55 TFSI e quattro	nov-20	In produzione	7	AB6102AT + AB6103AT * + AB6105AT *	AB6104AT * AB6106AT *	VW G055529A2 + G055549A2
AUDI	Q5 Van (8RB)	2.0 TDI; 2.0 TDI quattro; 2.0 TFSI quattro; 3.0 SQ5 TDI quattro; 3.0 TDI quattro; 3.2 FSI quattro	nov-08	mag-17	8	AB6166AT	-	ZF Lifeguard Fluid 8
AUDI	Q5 Van (8RB)	2.0 TDI; 2.0 TDI quattro; 2.0 TFSI quattro; 3.0 SQ5 TDI quattro; 3.0 TDI quattro; 3.2 FSI quattro	nov-08	mag-17	7	AB6107AT + AB6108AT *	AB6109AT * AB6110AT *	VW G052529A2 + G055532A2
AUDI	Q5 Van (FYB, FYG)	3.0 TDI quattro	lug-17	nov-20	8	AB6168AT	-	ZF Lifeguard Fluid 8
AUDI	Q7 (4LB)	3.0 TDI quattro; 3.0 TFSI quattro; 3.6 FSI quattro; 4.2 FSI quattro; 4.2 TDI quattro	mar-06	ago-15	6	AB6010AT	-	VW G055025A2

Marca / Brand:	Modello / Model:	Versioni / Version:	Da anno / From:	Ad anno / To:	Marce / Gears:	Codice AB PARTS		Lubrificante Consigliato
AUDI	Q7 (4LB)	3.0 TDI quattro; 3.0 TFSI quattro; 3.6 FSI quattro; 4.2 FSI quattro; 4.2 TDI quattro; 6.0 TDI quattro	mar-06	ago-15	8	AB6011AT	-	VW G055540A2
AUDI	Q7 (4LB)	3.0 TFSI quattro	mag-10	ago-15	7	AB6024AT	-	Meccatronica: VW G004000 Cambio: VW G052171
AUDI	Q7 (4LB)	3.6 FSI quattro	ago-06	mag-10	6	AB6152AT *	AB6153AT *	DEXRON VI
AUDI	Q7 (4MB, 4MG)	2.0 TFSI quattro; 3.0 TDI quattro; 3.0 TFSI quattro; 45 TDI Mild Hybrid quattro; 45 TDI quattro; 45 TFSI quattro; 50 TDI Mild Hybrid quattro; 55 TFSI Mild Hybrid quattro; 55 TFSI quattro	gen-15	In produzione	8	AB6169AT	-	ZF Lifeguard Fluid 8
AUDI	Q7 (4MB, 4MG)	2.0 TFSI quattro; 3.0 TDI quattro; 3.0 TFSI quattro; 45 TDI quattro; 45 TFSI quattro; 55 TFSI quattro	gen-15	In produzione	8	AB6168AT	-	ZF Lifeguard Fluid 8
AUDI	Q7 (4MB, 4MG)	2.0 TFSI quattro; 3.0 TDI quattro; 3.0 TFSI quattro; 45 TDI quattro; 55 TFSI quattro; SQ7 quattro; SQ7 TDI quattro	gen-15	In produzione	8	AB6174AT	-	ZF Lifeguard Fluid 8
AUDI	Q7 Van (4LB)	3.0 TDI quattro; 3.0 TFSI quattro; 3.6 FSI quattro; 4.2 FSI quattro; 4.2 TDI quattro	mar-06	ago-15	6	AB6010AT	-	VW G055025A2
AUDI	Q7 Van (4LB)	3.0 TDI quattro; 3.0 TFSI quattro; 3.6 FSI quattro; 4.2 FSI quattro; 4.2 TDI quattro; 6.0 TDI quattro	mar-06	ago-15	8	AB6011AT	-	VW G055540A2
AUDI	Q7 Van (4LB)	3.6 FSI quattro	ago-06	mag-10	6	AB6152AT *	AB6153AT *	DEXRON VI
AUDI	Q7 Van (4MB, 4MG)	3.0 45 TDI Mild Hybrid quattro; 3.0 50 TDI Mild Hybrid quattro; 3.0 TDI quattro	gen-15	dic-19	8	AB6169AT	-	ZF Lifeguard Fluid 8
AUDI	Q7 Van (4MB, 4MG)	3.0 TDI quattro	gen-15	dic-19	8	AB6168AT	-	ZF Lifeguard Fluid 8
AUDI	Q7 Van (4MB, 4MG)	3.0 TDI quattro; 4.0 SQ7 TDI quattro	gen-15	In produzione	8	AB6174AT	-	ZF Lifeguard Fluid 8
AUDI	Q8 (4MN, 4MT)	45 TDI quattro; 45 TFSI quattro	feb-18	In produzione	8	AB6168AT	-	ZF Lifeguard Fluid 8
AUDI	Q8 (4MN, 4MT)	45 TDI quattro; 45 TFSI quattro; SQ8 quattro; SQ8 TDI Mild Hybrid quattro	feb-18	In produzione	8	AB6174AT	-	ZF Lifeguard Fluid 8
AUDI	Q8 (4MN, 4MT)	45 TFSI quattro	ott-19	In produzione	8	AB6169AT	-	ZF Lifeguard Fluid 8
AUDI	Q8 (4MN, 4MT)	RS Mild Hybrid quattro; SQ8 quattro; SQ8 TDI Mild Hybrid quattro	mag-18	In produzione	8	AB6175AT	-	ZF Lifeguard Fluid 8
AUDI	R8 (422, 423)	4.2 FSI quattro; 5.2 FSI quattro	apr-09	lug-15	7	AB6029AT + AB6031AT *	AB6032AT *	VW G055529A2
AUDI	R8 (422, 423)	4.2 FSI quattro; 5.2 FSI quattro	apr-09	lug-15	7	AB6029AT + AB6031AT *	AB6032AT *	VW G055529A2
AUDI	R8 Spyder (427, 429)	4.2 FSI quattro; 5.2 FSI quattro	feb-10	lug-15	7	AB6029AT + AB6031AT *	AB6032AT *	VW G055529A2
AUDI	R8 Spyder (427, 429)	4.2 FSI quattro; 5.2 FSI quattro	feb-10	lug-15	7	AB6029AT + AB6031AT *	AB6032AT *	VW G055529A2
AUDI	TT (8J3)	1.8 TFSI; 2.0 TDI quattro; 2.0 TFSI; 2.0 TFSI quattro; 2.0 TTS quattro	mag-08	giu-14	7	AB6024AT	-	Meccatronica: VW G004000 Cambio: VW G052171
AUDI	TT (8J3)	1.8 TFSI; 2.0 TDI quattro; 2.0 TFSI; 2.0 TFSI quattro; 2.0 TTS quattro; 3.2 V6 quattro	ago-06	giu-14	6	AB6025AT + AB6027AT	-	VW G052182
AUDI	TT (8J3)	2.0 TDI quattro; 2.0 TFSI; 2.0 TFSI quattro; 2.0 TTS quattro; 3.2 V6 quattro	ago-06	giu-14	6	AB6025AT + AB6026AT	-	VW G052182
AUDI	TT (8J3)	2.5 RS quattro	lug-09	giu-14	7	AB6029AT + AB6031AT *	AB6032AT *	VW G055529A2
AUDI	TT (8J3)	2.5 RS quattro	lug-09	giu-14	7	AB6029AT + AB6031AT *	AB6032AT *	VW G055529A2
AUDI	TT (8N3)	1.8 T; 1.8 T quattro; 3.2 VR6 quattro	ott-98	giu-06	6	AB6136AT	-	VW G055025A2

Marca / Brand:	Modello / Model:	Versioni / Version:	Da anno / From:	Ad anno / To:	Marce / Gears:	Codice AB PARTS		Lubrificante Consigliato
AUDI	TT (8N3)	3.2 VR6 quattro	lug-03	giu-06	6	AB6025AT + AB6026AT	-	VW G052182
AUDI	TT (8N3)	3.2 VR6 quattro	lug-03	giu-06	6	AB6025AT + AB6027AT	-	VW G052182
AUDI	TT (FV3, FVP)	1.8 TFSI	lug-15	ago-18	7	AB6024AT	-	Meccatronica: VW G004000 Cambio: VW G052171
AUDI	TT (FV3, FVP)	1.8 TFSI; 2.0 TDI quattro; 2.0 TFSI; 2.0 TFSI quattro; 2.0 TTS quattro	lug-14	In produzione	6	AB6025AT + AB6026AT	-	VW G052182
AUDI	TT Roadster (8J9)	1.8 TFSI; 2.0 TDI quattro; 2.0 TFSI; 2.0 TFSI quattro; 2.0 TTS quattro	mag-08	giu-14	7	AB6024AT	-	Meccatronica: VW G004000 Cambio: VW G052171
AUDI	TT Roadster (8J9)	1.8 TFSI; 2.0 TDI quattro; 2.0 TFSI; 2.0 TFSI quattro; 2.0 TTS quattro; 3.2 V6 quattro	mar-07	giu-14	6	AB6025AT + AB6027AT	-	VW G052182
AUDI	TT Roadster (8J9)	2.0 TDI quattro; 2.0 TFSI; 2.0 TFSI quattro; 2.0 TTS quattro; 3.2 V6 quattro	mar-07	giu-14	6	AB6025AT + AB6026AT	-	VW G052182
AUDI	TT Roadster (8J9)	2.5 RS quattro	lug-09	giu-14	7	AB6029AT + AB6031AT *	- AB6032AT *	VW G05529A2
AUDI	TT Roadster (8J9)	2.5 RS quattro	lug-09	giu-14	7	AB6029AT + AB6031AT *	- AB6032AT *	VW G05529A2
AUDI	TT Roadster (8N9)	3.2 VR6 quattro	lug-03	giu-06	6	AB6025AT + AB6026AT	-	VW G052182
AUDI	TT Roadster (8N9)	3.2 VR6 quattro	lug-03	giu-06	6	AB6025AT + AB6027AT	-	VW G052182
AUDI	TT Roadster (FV9, FVR)	1.8 TFSI	lug-15	ago-18	7	AB6024AT	-	Meccatronica: VW G004000 Cambio: VW G052171
AUDI	TT Roadster (FV9, FVR)	1.8 TFSI; 2.0 TDI quattro; 2.0 TFSI; 2.0 TFSI quattro; 2.0 TTS quattro	nov-14	In produzione	6	AB6025AT + AB6026AT	-	VW G052182
AUDI	V8 (441, 442, 4C2, 4C8)	3.6 quattro; 4.2 quattro	ott-88	feb-94	4	AB6147AT	-	DEXRON III
BENTLEY	ARNAGE (RBS_)	4.4 V8; 6.7 V8; 6.8 V8 T	mar-98	dic-13	6	AB6163AT	-	ZF Lifeguard Fluid 6
BENTLEY	BENTAYGA (4V1)	4.0; 4.0 D; 4.0 TDI; 6.0	ott-15	In produzione	8	AB6174AT	-	ZF Lifeguard Fluid 8
BENTLEY	CONTINENTAL Cabriolet (3W_, 394)	6.0 AWD; 6.0 GTC Speed AWD	giu-06	apr-11	6	AB6158AT *	AB6159AT *	VW G055005A2 (benzina) VW G055162A2 (diesel)
BENTLEY	CONTINENTAL Coupé (3W_, 393)	6.0 GT; 6.0 GT Speed	giu-03	dic-11	6	AB6158AT *	AB6159AT *	VW G055005A2 (benzina) VW G055162A2 (diesel)
BENTLEY	CONTINENTAL FLYING SPUR (3W_)	6.0; 6.0 FLEX; 6.0 Speed	mar-05	dic-13	6	AB6158AT *	AB6159AT *	VW G055005A2 (benzina) VW G055162A2 (diesel)
BMW	1 (E81)	116 d; 116 i; 118 d; 118 i; 120 d; 120 i; 123 d; 130 i	set-06	set-12	6	AB6162AT	-	DEXRON VI
BMW	1 (E81)	116 i; 118 i; 120 i; 130 i	set-06	dic-11	6	AB6049AT	-	DEXRON VI

Marca / Brand:	Modello / Model:	Versioni / Version:	Da anno / From:	Ad anno / To:	Marce / Gears:	Codice AB PARTS		Lubrificante Consigliato
BMW	1 (E87)	116 d; 116 i; 118 d; 118 i; 120 d; 120 i; 123 d; 130 i	giu-04	dic-11	6	AB6162AT	-	DEXRON VI
BMW	1 (E87)	116 i; 118 i; 120 i; 130 i	giu-04	giu-11	6	AB6049AT	-	DEXRON VI
BMW	1 (F20)	114 d; 114 i; 116 d; 116 i; 118 d; 118 d xDrive; 118 i; 120 d; 120 d xDrive; 120 i; 125 d; 125 i; M 135 i; M 135 i xDrive; M 140 i; M 140 i xDrive	lug-11	giu-19	8	AB6164AT	-	ZF Lifeguard Fluid 8
BMW	1 (F21)	114 d; 114 i; 116 d; 116 i; 118 d; 118 d xDrive; 118 i; 120 d; 120 d xDrive; 120 i; 125 d; 125 i; M 135 i; M 135 i xDrive; M 140 i; M 140 i xDrive	dic-11	dic-19	8	AB6164AT	-	ZF Lifeguard Fluid 8
BMW	1 Cabriolet (E88)	118 d; 118 i; 120 d; 120 i; 123 d; 125 i; 128 i; 135 i	dic-07	dic-13	6	AB6162AT	-	DEXRON VI
BMW	1 Cabriolet (E88)	118 i; 120 i; 125 i	dic-07	dic-13	6	AB6049AT	-	DEXRON VI
BMW	1 Cabriolet (E88)	135 i	mar-08	dic-13	7	AB6014AT + AB6015AT	-	BMW DCTF +1
BMW	1 Coupé (E82)	118 d; 120 d; 120 i; 123 d; 125 i; 135 i; M	set-07	ott-13	6	AB6162AT	-	DEXRON VI
BMW	1 Coupé (E82)	120 i; 125 i	mar-08	ott-13	6	AB6049AT	-	DEXRON VI
BMW	1 Coupé (E82)	135 i	ott-07	ott-13	7	AB6014AT + AB6015AT	-	BMW DCTF +1
BMW	2 Active Tourer (F45)	214 d; 216 d; 216 i; 218 d; 218 d xDrive; 218 i; 220 d; 220 d xDrive; 220 i; 225 i; 225 i xDrive; 225 xe Plug-in-Hybrid	nov-13	ott-21	8	AB6164AT	-	ZF Lifeguard Fluid 8
BMW	2 Active Tourer Van (F45)	218 i; 220 d	nov-14	ott-21	8	AB6164AT	-	ZF Lifeguard Fluid 8
BMW	2 Cabriolet (F23)	218 d; 218 i; 220 d; 220 i; 225 d; 228 i; 230 i; M 235 i; M 235 i xDrive; M 240 i; M 240 i xDrive	mar-14	giu-21	8	AB6164AT	-	ZF Lifeguard Fluid 8
BMW	2 Coupé (F22, F87)	218 d; 218 i; 220 d; 220 d xDrive; 220 i; 225 d; 228 i; 230 i; M 235 i; M 235 i xDrive; M 240 i; M 240 i xDrive; M2; M2 Competition; M2 CS	ott-12	giu-21	8	AB6164AT	-	ZF Lifeguard Fluid 8
BMW	2 Coupé (F22, F87)	M2; M2 Competition; M2 CS	nov-15	giu-21	7	AB6014AT + AB6015AT	-	BMW DCTF +1
BMW	2 Coupé (G42, G87)	218 i; 220 d Mild-Hybrid; 220 i; 230 i; M2; M240 i; M240 i xDrive	ago-21	In produzione	8	AB6164AT	-	ZF Lifeguard Fluid 8
BMW	2 Gran Coupe (F44)	216 d; 218 d; 218 i; 220 d; 220 d xDrive; 220 i; 220 i xDrive; M 235 i xDrive	nov-19	In produzione	8	AB6164AT	-	ZF Lifeguard Fluid 8
BMW	2 Gran Tourer (F46)	214 d; 216 d; 216 i; 218 d; 218 d xDrive; 218 i; 220 d; 220 d xDrive; 220 i	lug-14	In produzione	8	AB6164AT	-	ZF Lifeguard Fluid 8
BMW	2 Gran Tourer Van (F46)	218 i; 220 d	lug-14	In produzione	8	AB6164AT	-	ZF Lifeguard Fluid 8
BMW	3 (E30)	315; 316; 316 i; 318 i; 318 is; 320 i; 320 is; 323 i; 324 d; 324 td; 325 e 2.7; 325 i; 325 i X; M3 2.3; M3 EVO I 2.3; M3 EVO II 2.5	set-82	gen-92	4	AB6144AT *	AB6145AT *	DEXRON III
BMW	3 (E36)	316 i; 318 i; 318 is; 318 tds; 320 i; 323 i; 325 i; 325 td; 325 tds; 328 i; M3 3.0; M3 3.2	set-90	nov-98	4	AB6043AT	-	DEXRON III o DEXRON VI
BMW	3 (E36)	316 i; 318 i; 318 is; 318 tds; 320 i; 323 i; 325 i; 325 td; 325 tds; 328 i; M3 3.0; M3 3.2	set-90	nov-98	5	AB6148AT	-	Mobil LT 71141
BMW	3 (E46)	316 i; 318 d; 318 i; 320 d; 320 i; 323 i; 325 i; 325 xi; 328 i; 330 d; 330 xd; 330 xi	dic-97	mag-05	5	AB6047AT	-	GM - DEXRON VI ZF - LIFEGUARD 5
BMW	3 (E46)	316 i; 318 d; 318 i; 320 d; 320 i; 323 i; 325 xi; 328 i; 330 d; 330 i; 330 xd; 330 xi	feb-98	mag-05	5	AB6046AT	-	GM - DEXRON VI ZF - LIFEGUARD 5
BMW	3 (E46)	316 i; 318 i; 320 i; 323 i; 325 i; 325 xi; 328 i; 330 xi	feb-98	feb-05	5	AB6048AT	-	GM - DEXRON VI ZF - LIFEGUARD 5
BMW	3 (E46)	320 i; 323 i; 325 i; 328 i; 330 i	feb-98	feb-05	5	AB6150AT	-	ESSO LT 71141
BMW	3 (E46)	330 xd	set-02	dic-04	4	AB6043AT	-	DEXRON III o DEXRON VI
BMW	3 (E90)	316 d; 316 i; 318 d; 318 i; 320 d; 320 d xDrive; 320 i; 320 si; 323 i; 325 d; 325 i; 325 i xDrive; 325 xi; 330 d; 330 i; 330 i xDrive; 330 xi; 335 i; 335 i xDrive; 335 xi	dic-04	dic-11	6	AB6162AT	-	DEXRON VI
BMW	3 (E90)	318 i; 320 i; 323 i; 325 i; 325 i xDrive; 325 xi; 328 i; 330 i; 330 i xDrive; 330 xi	dic-04	dic-11	6	AB6049AT	-	DEXRON VI

Marca / Brand:	Modello / Model:	Versioni / Version:	Da anno / From:	Ad anno / To:	Marce / Gears:	Codice AB PARTS		Lubrificante Consigliato
BMW	3 (E90)	325 d; 330 d; 330 d xDrive; 330 xd; 335 d	set-05	dic-11	6	AB6163AT	-	ZF Lifeguard Fluid 6
BMW	3 (E90)	335 i; 335 i xDrive; 335 xi; M3	mar-06	dic-11	7	AB6014AT + AB6015AT	-	BMW DCTF +1
BMW	3 (F30, F80)	316 d; 316 i; 318 d; 318 d xDrive; 318 i; 320 d; 320 d xDrive; 320 i; 320 i xDrive; 325 d; 328 i; 328 i xDrive; 330 d; 330 d xDrive; 330 e; 330 i; 330 i xDrive; 335 d xDrive; 335 i; 335 i xDrive; 340 i; 340 i xDrive; ActiveHybrid; M3; M3 Competition; M3 CS	nov-11	ott-18	8	AB6164AT	-	ZF Lifeguard Fluid 8
BMW	3 (F30, F80)	330 e	nov-15	ott-18	8	AB6172AT	-	ZF Lifeguard Fluid 8
BMW	3 (F30, F80)	ActiveHybrid	lug-12	giu-15	8	AB6171AT	-	ZF Lifeguard Fluid 8
BMW	3 (F30, F80)	M3; M3 Competition; M3 CS	mar-14	ott-18	7	AB6014AT + AB6015AT	-	BMW DCTF +1
BMW	3 (G20, G80, G28)	316 d; 316 d Mild-Hybrid; 318 d; 318 d Mild-Hybrid; 318 i; 320 d; 320 d Mild-Hybrid; 320 d Mild-Hybrid xDrive; 320 d xDrive; 320 e Plug-in-Hybrid; 320 i; 320 i 1.6; 320 i xDrive; 330 d; 330 d Mild-Hybrid; 330 d Mild-Hybrid xDrive; 330 d xDrive; 330 e Plug-in-Hybrid; 330 e Plug-in-Hybrid xDrive; 330 i; 330 i xDrive; M 340 i Mild-Hybrid xDrive; M 340 i xDrive; M3; M3 Competition; M3 Competition xDrive; M3 CS xDrive; M340 d Mild-Hybrid xDrive	nov-18	In produzione	8	AB6164AT	-	ZF Lifeguard Fluid 8
BMW	3 (G20, G80, G28)	320 e Plug-in-Hybrid; 330 e Plug-in-Hybrid; 330 e Plug-in-Hybrid xDrive	lug-19	In produzione	8	AB6172AT	-	ZF Lifeguard Fluid 8
BMW	3 Cabriolet (E30)	316 i Baur TC; 318 Baur TC; 318 i; 318 i Baur TC; 320 i; 325 i; M3 2.3	set-82	nov-93	4	AB6144AT *	AB6145AT *	DEXRON III
BMW	3 Cabriolet (E36)	318 i; 320 i; 323 i; 325 i; 328 i; M3 3.0; M3 3.2	mar-93	nov-99	4	AB6043AT	-	DEXRON III o DEXRON VI
BMW	3 Cabriolet (E36)	318 i; 320 i; 323 i; 325 i; 328 i; M3 3.0; M3 3.2	mar-93	nov-99	5	AB6148AT	-	Mobil LT 71141
BMW	3 Cabriolet (E46)	318 Ci; 320 Cd; 320 Ci; 323 Ci; 325 Ci; 330 Cd; 330 Ci	apr-00	dic-07	5	AB6047AT	-	GM - DEXRON VI ZF - LIFEGUARD 5
BMW	3 Cabriolet (E46)	318 Ci; 320 Ci; 323 Ci; 325 Ci; 330 Ci	apr-00	dic-07	5	AB6048AT	-	GM - DEXRON VI ZF - LIFEGUARD 5
BMW	3 Cabriolet (E46)	318 Ci; 323 Ci; 325 Ci; 330 Ci	apr-00	dic-07	5	AB6046AT	-	GM - DEXRON VI ZF - LIFEGUARD 5
BMW	3 Cabriolet (E46)	320 Ci; 323 Ci; 325 Ci; 330 Ci	apr-00	dic-07	5	AB6150AT	-	ESSO LT 71141
BMW	3 Cabriolet (E93)	320 d; 320 i; 323 i; 325 d; 325 i; 330 i; 335 i	mag-06	dic-13	6	AB6162AT	-	DEXRON VI
BMW	3 Cabriolet (E93)	320 i; 323 i; 325 i; 330 i	set-06	dic-13	6	AB6049AT	-	DEXRON VI
BMW	3 Cabriolet (E93)	325 d; 330 d	mar-07	dic-13	6	AB6163AT	-	ZF Lifeguard Fluid 6
BMW	3 Cabriolet (E93)	335 i; M3	mag-06	ott-13	7	AB6014AT + AB6015AT	-	BMW DCTF +1
BMW	3 Compact (E36)	316 g; 316 i; 318 tds; 318 ti; 323 ti	gen-94	ago-00	4	AB6043AT	-	DEXRON III o DEXRON VI
BMW	3 Compact (E36)	316 g; 316 i; 318 tds; 318 ti; 323 ti	gen-94	ago-00	5	AB6148AT	-	Mobil LT 71141
BMW	3 Compact (E46)	316 ti; 318 td; 318 ti; 320 td; 325 ti	mar-01	feb-05	5	AB6047AT	-	GM - DEXRON VI ZF - LIFEGUARD 5
BMW	3 Compact (E46)	316 ti; 318 ti; 320 td	mar-01	feb-05	5	AB6046AT	-	GM - DEXRON VI ZF - LIFEGUARD 5
BMW	3 Compact (E46)	316 ti; 318 ti; 325 ti	mar-01	feb-05	5	AB6048AT	-	GM - DEXRON VI ZF - LIFEGUARD 5
BMW	3 Compact (E46)	325 ti	apr-01	dic-04	5	AB6150AT	-	ESSO LT 71141
BMW	3 Coupé (E36)	316 i; 318 is; 320 i; 323 i; 325 i; 328 i; M3 3.0; M3 3.2	ott-91	apr-99	4	AB6043AT	-	DEXRON III o DEXRON VI
BMW	3 Coupé (E36)	316 i; 318 is; 320 i; 323 i; 325 i; 328 i; M3 3.0; M3 3.2	ott-91	apr-99	5	AB6148AT	-	Mobil LT 71141

Marca / Brand:	Modello / Model:	Versioni / Version:	Da anno / From:	Ad anno / To:	Marce / Gears:	Codice AB PARTS		Lubrificante Consigliato
BMW	3 Coupé (E46)	318 Ci; 320 Cd; 320 Ci; 323 Ci; 325 Ci; 328 Ci; 330 Cd; 330 Ci	dic-98	lug-06	5	AB6047AT	-	GM - DEXRON VI ZF - LIFEGUARD 5
BMW	3 Coupé (E46)	318 Ci; 320 Ci; 323 Ci; 325 Ci; 328 Ci; 330 Cd; 330 Ci	dic-98	lug-06	5	AB6046AT	-	GM - DEXRON VI ZF - LIFEGUARD 5
BMW	3 Coupé (E46)	318 Ci; 320 Ci; 323 Ci; 325 Ci; 328 Ci; 330 Ci	dic-98	mag-06	5	AB6048AT	-	GM - DEXRON VI ZF - LIFEGUARD 5
BMW	3 Coupé (E46)	320 Ci; 323 Ci; 325 Ci; 328 Ci; 330 Ci	dic-98	mag-06	5	AB6150AT	-	ESSO LT 71141
BMW	3 Coupé (E92)	320 d; 320 d xDrive; 320 i; 323 i; 325 d; 325 i; 325 i xDrive; 325 xi; 330 i; 330 i xDrive; 330 xi; 335 i; 335 i xDrive; 335 xi; M3 GTS	apr-06	dic-13	6	AB6162AT	-	DEXRON VI
BMW	3 Coupé (E92)	320 i; 323 i; 325 i; 325 i xDrive; 325 xi; 328 i; 330 i; 330 i xDrive; 330 xi	apr-06	dic-13	6	AB6049AT	-	DEXRON VI
BMW	3 Coupé (E92)	325 d; 330 d; 330 d xDrive; 330 xd; 335 d	mar-06	giu-13	6	AB6163AT	-	ZF Lifeguard Fluid 6
BMW	3 Coupé (E92)	335 i; 335 i xDrive; 335 xi; M3	giu-06	dic-13	7	AB6014AT + AB6015AT	-	BMW DCTF +1
BMW	3 Gran Turismo (F34)	318 d; 320 d; 320 d xDrive; 320 i; 320 i xDrive; 325 d; 328 i; 328 i xDrive; 330 d; 330 d xDrive; 330 i; 330 i xDrive; 335 d xDrive; 335 i; 335 i xDrive; 340 i; 340 i xDrive	nov-12	In produzione	8	AB6164AT	-	ZF Lifeguard Fluid 8
BMW	3 Touring (E30)	316 i; 318 i; 320 i; 324 td; 325 i; 325 i X	lug-87	giu-94	4	AB6144AT *	AB6145AT *	DEXRON III
BMW	3 Touring (E36)	316 i; 318 i; 318 tds; 320 i; 323 i; 325 tds; 328 i	gen-95	mag-99	4	AB6043AT	-	DEXRON III o DEXRON VI
BMW	3 Touring (E36)	316 i; 318 i; 318 tds; 320 i; 323 i; 325 tds; 328 i	gen-95	mag-99	5	AB6148AT	-	Mobil LT 71141
BMW	3 Touring (E46)	316 i; 318 d; 318 i; 320 d; 320 i; 325 i; 325 xi; 328 i; 330 d; 330 xd; 330 xi	giu-99	lug-05	5	AB6047AT	-	GM - DEXRON VI ZF - LIFEGUARD 5
BMW	3 Touring (E46)	316 i; 318 d; 318 i; 320 d; 325 xi; 328 i; 330 d; 330 xd; 330 xi	giu-99	lug-05	5	AB6046AT	-	GM - DEXRON VI ZF - LIFEGUARD 5
BMW	3 Touring (E46)	316 i; 318 i; 320 i; 325 i; 325 xi; 328 i; 330 xi	giu-99	lug-05	5	AB6048AT	-	GM - DEXRON VI ZF - LIFEGUARD 5
BMW	3 Touring (E46)	320 i; 325 i; 328 i; 330 i	giu-99	feb-05	5	AB6150AT	-	ESSO LT 71141
BMW	3 Touring (E46)	330 xd	ago-02	mag-05	4	AB6043AT	-	DEXRON III o DEXRON VI
BMW	3 Touring (E91)	316 d; 316 i; 318 d; 318 i; 320 d; 320 d xDrive; 320 i; 323 i; 325 d; 325 i; 325 i xDrive; 325 xi; 330 d; 330 d xDrive; 330 i; 330 i xDrive; 330 xd; 330 xi; 335 d; 335 i; 335 i xDrive; 335 xi	dic-04	dic-12	6	AB6162AT	-	DEXRON VI
BMW	3 Touring (E91)	318 i; 320 i; 323 i; 325 i; 325 i xDrive; 325 xi; 330 i; 330 i xDrive; 330 xi	dic-04	giu-12	6	AB6049AT	-	DEXRON VI
BMW	3 Touring (E91)	325 d; 330 d; 330 d xDrive; 330 xd; 335 d	dic-04	giu-12	6	AB6163AT	-	ZF Lifeguard Fluid 6
BMW	3 Touring (E91)	335 i; 335 i xDrive; 335 xi	set-06	giu-12	7	AB6014AT + AB6015AT	-	BMW DCTF +1
BMW	3 Touring (F31)	316 d; 316 i; 318 d; 318 d xDrive; 318 i; 320 d; 320 d xDrive; 320 i; 320 i xDrive; 325 d; 328 i; 328 i xDrive; 330 d; 330 d xDrive; 330 i; 330 i xDrive; 335 d xDrive; 335 i; 335 i xDrive; 340 i; 340 i xDrive	lug-12	giu-19	8	AB6164AT	-	ZF Lifeguard Fluid 8
BMW	3 Touring (G21, G81)	316 d; 316 d Mild-Hybrid; 318 d; 318 d Mild-Hybrid; 318 i; 320 d; 320 d Mild-Hybrid; 320 d Mild-Hybrid xDrive; 320 d xDrive; 320 e Plug-in-Hybrid; 320 e Plug-in-Hybrid xDrive; 320 i; 330 d; 330 d Mild-Hybrid; 330 d Mild-Hybrid xDrive; 330 d xDrive; 330 e Plug-in-Hybrid; 330 i; 330 i xDrive; M 340 d Mild-Hybrid xDrive; M 340 i Mild-Hybrid xDrive; M 340 i xDrive; M3 Competition xDrive	lug-19	In produzione	8	AB6164AT	-	ZF Lifeguard Fluid 8
BMW	3 Touring (G21, G81)	320 e Plug-in-Hybrid; 320 e Plug-in-Hybrid xDrive; 330 e Plug-in-Hybrid; 330 e Plug-in-Hybrid xDrive	lug-20	In produzione	8	AB6172AT	-	ZF Lifeguard Fluid 8
BMW	3 Touring Van (F31)	330 d xDrive; 330 i; 340 i	mar-13	giu-19	8	AB6164AT	-	ZF Lifeguard Fluid 8
BMW	3 Touring Van (G21)	318 d; 320 d; 320 d Mild-Hybrid; 320 d Mild-Hybrid xDrive; 320 d xDrive; 320 i; 330 d; 330 d xDrive; 330 i; M 340 i xDrive	lug-19	In produzione	8	AB6164AT	-	ZF Lifeguard Fluid 8

Marca / Brand:	Modello / Model:	Versioni / Version:	Da anno / From:	Ad anno / To:	Marce / Gears:	Codice AB PARTS		Lubrificante Consigliato
BMW	4 Cabriolet (F33, F83)	420 d; 420 i; 425 d; 428 i; 428 i xDrive; 430 d; 430 i; 430 i xDrive; 435 d xDrive; 435 i; 435 i xDrive; 440 i; 440 i xDrive; M4; M4 Competition	ott-13	lug-20	8	AB6164AT	-	ZF Lifeguard Fluid 8
BMW	4 Cabriolet (F33, F83)	M4; M4 Competition	lug-14	lug-20	7	AB6014AT + AB6015AT	-	BMW DCTF +1
BMW	4 Cabriolet (G23, G83)	420 d Mild-Hybrid; 420 i; 430 d Mild-Hybrid; 430 i; 430 i xDrive; M 440 i Mild-Hybrid; M 440 i Mild-Hybrid xDrive; M4 Competition M xDrive; M440 d Mild-Hybrid xDrive	nov-20	In produzione	8	AB6164AT	-	ZF Lifeguard Fluid 8
BMW	4 Coupé (F32, F82)	418 d; 418 i; 420 d; 420 d xDrive; 420 i; 420 i xDrive; 425 d; 428 i; 428 i xDrive; 430 d; 430 d xDrive; 430 i; 430 i xDrive; 435 d xDrive; 435 i; 435 i xDrive; 440 i; 440 i xDrive; M4; M4 Competition; M4 CS; M4 GTS	lug-13	giu-20	8	AB6164AT	-	ZF Lifeguard Fluid 8
BMW	4 Coupé (F32, F82)	M4 GTS	mar-16	giu-19	8	AB6173AT	-	ZF Lifeguard Fluid 8
BMW	4 Coupé (F32, F82)	M4; M4 Competition; M4 CS; M4 GTS	mar-14	giu-20	7	AB6014AT + AB6015AT	-	BMW DCTF +1
BMW	4 Coupé (G22, G82)	3.0 M4 3.0 CSL; 420 d Mild-Hybrid; 420 d Mild-Hybrid xDrive; 420 i; 420 i 1.6; 420 i xDrive; 430 d Mild-Hybrid xDrive; 430 i; 430 i xDrive; M 440 i Mild-Hybrid; M 440 i Mild-Hybrid xDrive; M4; M4 Competition; M4 Competition M xDrive; M4 CSL; M440 d Mild-Hybrid xDrive	lug-20	In produzione	8	AB6164AT	-	ZF Lifeguard Fluid 8
BMW	4 Gran Coupe (F36)	418 d; 418 i; 420 d; 420 d xDrive; 420 i; 420 i xDrive; 425 d; 428 i; 428 i xDrive; 430 d; 430 d xDrive; 430 i; 430 i xDrive; 435 d xDrive; 435 i; 435 i xDrive; 440 i; 440 i xDrive	mar-14	mag-21	8	AB6164AT	-	ZF Lifeguard Fluid 8
BMW	4 Gran Coupe (G26)	420 d Mild-Hybrid; 420 d Mild-Hybrid xDrive; 420 i; 430 d Mild-Hybrid xDrive; 430 i; 430 i xDrive; M440 i Mild-Hybrid; M440 i Mild-Hybrid xDrive	lug-21	In produzione	8	AB6164AT	-	ZF Lifeguard Fluid 8
BMW	5 (E28)	518; 518 i; 520 i; 524 d; 524 td; 525 e; 525 i; 528 i; 535 i; 535 i, M 535 i; M5; M535 i	mag-81	dic-87	4	AB6144AT *	AB6145AT *	DEXRON III
BMW	5 (E34)	518 i; 520 i; 520 i 24V; 524 td; 525 i; 525 i 24V; 525 iX 24V; 525 td; 525 tds; 530 i; 530 i V8; 535 i; 540 i V8; M5	giu-87	dic-95	4	AB6043AT	-	DEXRON III o DEXRON VI
BMW	5 (E34)	518 i; 520 i; 520 i 24V; 524 td; 525 i; 525 i 24V; 525 iX 24V; 525 td; 525 tds; 530 i; 530 i V8; 535 i; 540 i V8; M5	giu-87	dic-95	5	AB6148AT	-	Mobil LT 71141
BMW	5 (E34)	518 i; 520 i; 520 i 24V; 524 td; 525 i; 525 i 24V; 525 iX 24V; 525 td; 525 tds; 530 i; 530 i V8; 535 i; 540 i V8; M5	giu-87	dic-95	4	AB6145AT	-	DEXRON III
BMW	5 (E39)	520 d; 520 i; 523 i; 525 d; 525 i; 525 td; 525 tds; 528 i; 530 d; 530 i; 535 i; 540 i; M5	set-95	giu-03	5	AB6148AT	-	Mobil LT 71141
BMW	5 (E39)	520 d; 520 i; 523 i; 525 d; 525 i; 525 td; 525 tds; 528 i; 530 d; 530 i; 535 i; 540 i; M5	set-95	giu-03	5	AB6151AT	-	ESSO LT 71141
BMW	5 (E39)	520 i; 523 i; 525 i; 528 i; 530 i	set-95	giu-03	5	AB6150AT	-	ESSO LT 71141
BMW	5 (E39)	523 i; 525 d; 525 i; 528 i; 530 d; 530 i	set-95	giu-03	5	AB6046AT	-	GM - DEXRON VI ZF - LIFEGUARD 5
BMW	5 (E39)	525 i; 528 i; 530 d; 530 i	set-95	giu-03	5	AB6047AT	-	GM - DEXRON VI ZF - LIFEGUARD 5
BMW	5 (E39)	525 i; 528 i; 530 i	set-95	giu-03	5	AB6048AT	-	GM - DEXRON VI ZF - LIFEGUARD 5
BMW	5 (E39)	530 i	set-00	giu-03	6	AB6162AT	-	DEXRON VI
BMW	5 (E60)	520 d; 520 i; 523 i; 525 d; 525 d xDrive; 525 i; 525 i xDrive; 525 xd; 525 xi; 530 d; 530 d xDrive; 530 i; 530 i xDrive; 530 xd; 530 xi; 535 d; 535 i; 540 i; 545 i; 550 i; M5	dic-01	mar-10	6	AB6162AT	-	DEXRON VI
BMW	5 (E60)	525 d; 525 d xDrive; 525 xd; 530 d; 530 d xDrive; 530 xd; 535 d; 540 i; 545 i; 550 i	set-02	mar-10	6	AB6163AT	-	ZF Lifeguard Fluid 6
BMW	5 (F10)	518 d; 520 d; 520 d xDrive; 520 i; 523 i; 525 d; 525 d xDrive; 528 i; 528 i xDrive; 530 d; 530 d xDrive; 530 i; 535 d; 535 d xDrive; 535 i; 535 i xDrive; 550 i; 550 i xDrive; ActiveHybrid; M 550 d xDrive; M5; M5 30th Anniversary; M5 Competition	giu-09	ott-16	8	AB6164AT	-	ZF Lifeguard Fluid 8
BMW	5 (F10)	550 i; 550 i xDrive; M5; M5 30th Anniversary; M5 Competition	mar-10	ott-16	8	AB6173AT	-	ZF Lifeguard Fluid 8

Marca / Brand:	Modello / Model:	Versioni / Version:	Da anno / From:	Ad anno / To:	Marce / Gears:	Codice AB PARTS		Lubrificante Consigliato
BMW	5 (F10)	ActiveHybrid	dic-11	ott-16	8	AB6171AT	-	ZF Lifeguard Fluid 8
BMW	5 (F10)	M5; M5 30th Anniversary; M5 Competition	set-11	ott-16	7	AB6014AT + AB6015AT	-	BMW DCTF +1
BMW	5 (G30, F90)	518 d; 518 d Mild-Hybrid; 520 d; 520 d Mild-Hybrid; 520 d Mild-Hybrid xDrive; 520 d xDrive; 520 E PLUG-IN-HYBRID; 520 i; 520 i Mild-Hybrid; 525 d; 530 d; 530 d Mild-Hybrid; 530 d Mild-Hybrid xDrive; 530 d xDrive; 530 e Plug-in-Hybrid; 530 e Plug-in-Hybrid xDrive; 530 i; 530 i Mild-Hybrid; 530 i Mild-Hybrid xDrive; 530 i xDrive; 540 d Mild-Hybrid xDrive; 540 d xDrive; 540 i; 540 i Mild-Hybrid; 540 i Mild-Hybrid xDrive; 540 i xDrive; 545 e Plug-in-Hybrid xDrive; M 550 d xDrive; M 550 i xDrive; M5; M5 Competition; M5 CS	set-16	In produzione	8	AB6164AT	-	ZF Lifeguard Fluid 8
BMW	5 (G30, F90)	520 E PLUG-IN-HYBRID; 530 e Plug-in-Hybrid; 530 e Plug-in-Hybrid xDrive	mar-17	giu-23	8	AB6172AT	-	ZF Lifeguard Fluid 8
BMW	5 (G30, F90)	M5; M5 Competition	set-17	giu-23	8	AB6173AT	-	ZF Lifeguard Fluid 8
BMW	5 Gran Turismo (F07)	520 d; 528 i; 530 d; 530 d xDrive; 535 d; 535 d xDrive; 535 i; 535 i xDrive; 550 i; 550 i xDrive	gen-09	feb-17	8	AB6164AT	-	ZF Lifeguard Fluid 8
BMW	5 Gran Turismo (F07)	550 i; 550 i xDrive	ago-09	giu-12	8	AB6173AT	-	ZF Lifeguard Fluid 8
BMW	5 Touring (E34)	518 g; 518 i; 520 i; 525 i; 525 ix; 525 td; 525 tds; 530 i; 540 i; M5	lug-91	lug-96	4	AB6043AT	-	DEXRON III o DEXRON VI
BMW	5 Touring (E34)	518 g; 518 i; 520 i; 525 i; 525 ix; 525 td; 525 tds; 530 i; 540 i; M5	lug-91	lug-96	5	AB6148AT	-	Mobil LT 71141
BMW	5 Touring (E34)	518 g; 518 i; 520 i; 525 i; 525 ix; 525 td; 525 tds; 530 i; 540 i; M5	lug-91	lug-96	4	AB6145AT	-	DEXRON III
BMW	5 Touring (E39)	520 d; 520 i; 523 i; 525 d; 525 i; 525 tds; 528 i; 530 d; 530 i; 540 i	nov-96	mag-04	5	AB6148AT	-	Mobil LT 71141
BMW	5 Touring (E39)	520 d; 520 i; 523 i; 525 d; 525 i; 525 tds; 528 i; 530 d; 530 i; 540 i	nov-96	mag-04	5	AB6151AT	-	ESSO LT 71141
BMW	5 Touring (E39)	520 i; 523 i; 525 i; 528 i; 530 i	nov-96	mag-04	5	AB6150AT	-	ESSO LT 71141
BMW	5 Touring (E39)	525 d; 525 i; 528 i; 530 d	nov-96	mag-04	5	AB6046AT	-	GM - DEXRON VI ZF - LIFEGUARD 5
BMW	5 Touring (E39)	525 d; 525 i; 528 i; 530 d; 530 i	nov-96	mag-04	5	AB6047AT	-	GM - DEXRON VI ZF - LIFEGUARD 5
BMW	5 Touring (E39)	525 i; 528 i; 530 i	nov-96	mag-04	5	AB6048AT	-	GM - DEXRON VI ZF - LIFEGUARD 5
BMW	5 Touring (E61)	520 d; 520 i; 523 i; 525 d; 525 d xDrive; 525 i; 525 i xDrive; 525 xd; 525 xi; 530 d; 530 d xDrive; 530 i; 530 i xDrive; 530 xd; 530 xi; 535 d; 545 i; 550 i; M5	mar-04	dic-10	6	AB6162AT	-	DEXRON VI
BMW	5 Touring (E61)	525 d; 525 d xDrive; 525 xd; 530 d; 530 d xDrive; 530 xd; 535 d; 545 i; 550 i	mar-04	dic-10	6	AB6163AT	-	ZF Lifeguard Fluid 6
BMW	5 Touring (E61)	M5	feb-07	dic-10	8	AB6173AT	-	ZF Lifeguard Fluid 8
BMW	5 Touring (F11)	518 d; 520 d; 520 d xDrive; 520 i; 523 i; 525 d; 525 d xDrive; 528 i; 528 i xDrive; 530 d; 530 d xDrive; 530 i; 535 d; 535 d xDrive; 535 i; 535 i xDrive; 550 i; M 550 d xDrive	nov-09	feb-17	8	AB6164AT	-	ZF Lifeguard Fluid 8
BMW	5 Touring (G31)	518 d; 518 d Mild-Hybrid; 520 d; 520 d Mild-Hybrid; 520 d Mild-Hybrid xDrive; 520 d xDrive; 520 E PLUG-IN-HYBRID; 520 i; 520 i Mild-Hybrid; 525 d; 530 d; 530 d Mild-Hybrid; 530 d Mild-Hybrid xDrive; 530 d xDrive; 530 e Plug-in-Hybrid; 530 e Plug-in-Hybrid xDrive; 530 i; 530 i Mild-Hybrid; 530 i Mild-Hybrid xDrive; 530 i xDrive; 540 d Mild-Hybrid xDrive; 540 d xDrive; 540 i Mild-Hybrid xDrive; 540 i xDrive; M 550 d xDrive	mar-17	In produzione	8	AB6164AT	-	ZF Lifeguard Fluid 8
BMW	5 Touring (G31)	520 E PLUG-IN-HYBRID; 530 e Plug-in-Hybrid; 530 e Plug-in-Hybrid xDrive	nov-20	In produzione	8	AB6172AT	-	ZF Lifeguard Fluid 8
BMW	5 Touring Van (G31)	520 d; 520 d xDrive; 520 i; 530 d; 530 d xDrive; 540 d xDrive; 540 i xDrive	mar-17	In produzione	8	AB6164AT	-	ZF Lifeguard Fluid 8
BMW	6 (E24)	628 CSI; 630 CS; 633 CSI; 635 CSI; M 635 CSI	ott-75	apr-89	4	AB6144AT *	AB6145AT *	DEXRON III
BMW	6 (E63)	630 i; 635 d; 645 Ci; 650 i; M	set-03	ago-10	6	AB6162AT	-	DEXRON VI

Marca / Brand:	Modello / Model:	Versioni / Version:	Da anno / From:	Ad anno / To:	Marce / Gears:	Codice AB PARTS		Lubrificante Consigliato
BMW	6 (E63)	635 d; 645 Ci; 650 i	set-03	ago-10	6	AB6163AT	-	ZF Lifeguard Fluid 6
BMW	6 Cabriolet (E64)	630 i; 635 d; 645 Ci; 650 i; M6	apr-04	ago-10	6	AB6162AT	-	DEXRON VI
BMW	6 Cabriolet (E64)	635 d; 645 Ci; 650 i	apr-04	ago-10	6	AB6163AT	-	ZF Lifeguard Fluid 6
BMW	6 Cabriolet (E64)	M6	set-06	ago-10	8	AB6173AT	-	ZF Lifeguard Fluid 8
BMW	6 Cabriolet (F12)	640 d; 640 d xDrive; 640 i; 640 i xDrive; 650 i; 650 i xDrive; M6; M6 Competition	dic-10	giu-18	8	AB6164AT	-	ZF Lifeguard Fluid 8
BMW	6 Cabriolet (F12)	650 i	set-11	dic-12	8	AB6173AT	-	ZF Lifeguard Fluid 8
BMW	6 Cabriolet (F12)	M6; M6 Competition	mar-12	giu-18	7	AB6014AT + AB6015AT	-	BMW DCTF +1
BMW	6 Coupé (F13)	640 d; 640 d xDrive; 640 i; 640 i xDrive; 650 i; 650 i xDrive; M6; M6 Competition	lug-11	ott-17	8	AB6164AT	-	ZF Lifeguard Fluid 8
BMW	6 Coupé (F13)	650 i	set-11	dic-12	8	AB6173AT	-	ZF Lifeguard Fluid 8
BMW	6 Coupé (F13)	M6; M6 Competition	lug-12	ott-17	7	AB6014AT + AB6015AT	-	BMW DCTF +1
BMW	6 Gran Coupe (F06)	640 d; 640 d xDrive; 640 i; 640 i xDrive; 650 i; 650 i xDrive	mar-12	ott-18	8	AB6164AT	-	ZF Lifeguard Fluid 8
BMW	6 Gran Coupe (F06)	M6; M6 Competition	mar-13	ott-18	7	AB6014AT + AB6015AT	-	BMW DCTF +1
BMW	6 Gran Turismo (G32)	620 d; 620 d Mild-Hybrid; 620 d Mild-Hybrid xDrive; 620 d xDrive; 630 d; 630 d Mild-Hybrid; 630 d Mild-Hybrid xDrive; 630 d xDrive; 630 i; 630 i Mild-Hybrid; 630 i xDrive; 640 d Mild-Hybrid xDrive; 640 d xDrive; 640 i; 640 i Mild-Hybrid; 640 i Mild-Hybrid xDrive; 640 i xDrive	giu-17	In produzione	8	AB6164AT	-	ZF Lifeguard Fluid 8
BMW	7 (E23)	728; 730; 728 i; 732 i; 733 i; 735 i; 745 i	mag-77	set-86	4	AB6144AT *	AB6145AT *	DEXRON III
BMW	7 (E32)	730 i, iL; 730 i, iL V8; 735 i, iL; 740 i, iL V8; 750 i, iL V12	mar-85	set-94	4	AB6145AT	-	DEXRON III
BMW	7 (E32)	730 i, iL; 735 i, iL; 750 i, iL V12	mar-85	set-94	4	AB6144AT *	AB6145AT *	DEXRON III
BMW	7 (E38)	725 tds; 728 i, iL; 730 d; 730 i, iL; 735 i, iL; 740 d; 740 i, iL; 750 i, iL	mar-94	nov-01	5	AB6148AT	-	Mobil LT 71141
BMW	7 (E38)	725 tds; 728 i, iL; 730 d; 730 i, iL; 735 i, iL; 740 d; 740 i, iL; 750 i, iL	mar-94	nov-01	5	AB6151AT	-	ESSO LT 71141
BMW	7 (E38)	728 i, iL	ago-95	nov-01	5	AB6150AT	-	ESSO LT 71141
BMW	7 (E65, E66, E67)	730 d; 730 i, Li; 730 Ld; 735 i, Li; 740 d; 740 i, Li; 745 d; 745 i, Li; 750 i, Li; 760 i, Li	lug-01	ago-08	6	AB6162AT	-	DEXRON VI
BMW	7 (E65, E66, E67)	730 d; 730 Ld; 735 i, Li; 740 d; 740 i, Li; 745 d; 745 i, Li; 750 i, Li; 760 i, Li	lug-01	ago-08	6	AB6163AT	-	ZF Lifeguard Fluid 6
BMW	7 (E65, E66, E67)	745 d	mar-05	lug-08	6	AB6156AT *	AB6157AT *	ZF Lifeguard Fluid 6
BMW	7 (F01, F02, F03, F04)	730 d; 730 d xDrive; 730 i, Li; 740 d; 740 d xDrive; 740 i, Li; 740 i, Li xDrive; 750 d xDrive; 750 i, Li; 750 i, Li xDrive; 760 i, Li; ActiveHybrid 7	feb-08	dic-15	6	AB6162AT	-	DEXRON VI
BMW	7 (F01, F02, F03, F04)	730 d; 730 d xDrive; 730 i, Li; 740 d; 740 d xDrive; 740 i, Li; 750 d xDrive; 750 i, Li; 750 i, Li xDrive; 760 i, Li; ActiveHybrid 7	set-08	dic-15	6	AB6163AT	-	ZF Lifeguard Fluid 6
BMW	7 (F01, F02, F03, F04)	730 i, Li; 740 d; 740 d xDrive; 740 i, Li; 740 i, Li xDrive; 750 d xDrive; 750 i, Li; 750 i, Li xDrive	set-08	dic-15	8	AB6164AT	-	ZF Lifeguard Fluid 8
BMW	7 (F01, F02, F03, F04)	750 i, Li; 760 i, Li	set-08	dic-15	8	AB6173AT	-	ZF Lifeguard Fluid 8
BMW	7 (F01, F02, F03, F04)	ActiveHybrid 7	apr-10	giu-15	8	AB6171AT	-	ZF Lifeguard Fluid 8
BMW	7 (G11, G12)	725 d, Ld; 730 d; 730 d Mild-Hybrid xDrive; 730 d xDrive; 730 d, Ld Mild-Hybrid; 730 d, Ld Mild-Hybrid xDrive; 730 d, Ld xDrive; 730 i; 730 i, Li; 740 d, Ld Mild-Hybrid xDrive; 740 d, Ld xDrive; 740 e, Le; 740 i, Li; 740 i, Li; 740 Le xDrive; 740 Li xDrive; 745 e, Le Plug-in-Hybrid; 745 Le Plug-in-Hybrid xDrive; 750 d, Ld xDrive; 750 i, Li; 750 i, Li xDrive; M 760 i, Li xDrive; M 760 Li xDrive	lug-15	giu-22	8	AB6164AT	-	ZF Lifeguard Fluid 8
BMW	7 (G11, G12)	740 e, Le; 740 Le xDrive; 745 e, Le Plug-in-Hybrid; 745 Le Plug-in-Hybrid xDrive	lug-16	giu-22	8	AB6172AT	-	ZF Lifeguard Fluid 8

Marca / Brand:	Modello / Model:	Versioni / Version:	Da anno / From:	Ad anno / To:	Marce / Gears:	Codice AB PARTS		Lubrificante Consigliato
BMW	8 (E31)	840 Ci; 840 i; 850 Ci; 850 CSI; 850 i, Ci	gen-90	dic-99	4	AB6145AT	-	DEXRON III
BMW	8 (E31)	840 Ci; 840 i; 850 Ci; 850 CSI; 850 i, Ci	gen-90	dic-99	5	AB6151AT	-	ESSO LT 71141
BMW	8 Cabriolet (G14, F91)	840 d xDrive; 840 i; 840 i xDrive; M 850 i xDrive	nov-18	In produzione	8	AB6164AT	-	ZF Lifeguard Fluid 8
BMW	8 Coupé (G15, F92)	840 d xDrive; 840 i; 840 i xDrive; M 850 i xDrive	lug-18	In produzione	8	AB6164AT	-	ZF Lifeguard Fluid 8
BMW	8 Gran Coupe (G16, F93)	840 d xDrive; 840 i; 840 i xDrive; M 850 i xDrive	lug-19	In produzione	8	AB6164AT	-	ZF Lifeguard Fluid 8
BMW	X1 (E84)	sDrive 16 d; sDrive 16 i; sDrive 18 d; sDrive 18 i; sDrive 20 d; sDrive 20 i; xDrive 18 d; xDrive 20 d; xDrive 20 i; xDrive 23 d; xDrive 25 d; xDrive 25 i; xDrive 28 i	mar-09	giu-15	8	AB6164AT	-	ZF Lifeguard Fluid 8
BMW	X1 (E84)	sDrive 16 d; sDrive 16 i; sDrive 18 d; sDrive 18 i; sDrive 20 d; sDrive 20 i; xDrive 18 d; xDrive 20 d; xDrive 20 i; xDrive 23 d; xDrive 25 d; xDrive 25 i; xDrive 28 i	mar-09	giu-15	6	AB6162AT	-	DEXRON VI
BMW	X1 (E84)	sDrive 18 i; xDrive 25 i; xDrive 28 i	set-09	giu-15	6	AB6049AT	-	DEXRON VI
BMW	X3 (E83)	2.0 d; 2.0 i; 2.0 sd; 2.5 i; 2.5 si; 2.5 si xDrive; 3.0 d; 3.0 i xDrive; 3.0 sd; 3.0 si; xDrive 18 d; xDrive 20 d; xDrive 20 i; xDrive 25 i; xDrive 30 d; xDrive 30 i; xDrive 35 d	set-03	dic-11	6	AB6162AT	-	DEXRON VI
BMW	X3 (E83)	2.5 i; 3.0 d; 3.0 i xDrive	set-03	lug-06	5	AB6047AT	-	GM - DEXRON VI ZF - LIFEGUARD 5
BMW	X3 (E83)	2.5 i; 3.0 d; 3.0 i xDrive; 3.0 sd	set-03	ago-08	5	AB6046AT	-	GM - DEXRON VI ZF - LIFEGUARD 5
BMW	X3 (E83)	2.5 i; 3.0 i xDrive	set-03	lug-06	5	AB6048AT	-	GM - DEXRON VI ZF - LIFEGUARD 5
BMW	X3 (E83)	2.5 si; 2.5 si xDrive; 3.0 i xDrive; 3.0 si; xDrive 25 i; xDrive 30 i	set-03	ago-10	6	AB6049AT	-	DEXRON VI
BMW	X3 (E83)	3.0 d; 3.0 sd	set-05	ago-08	6	AB6156AT *	AB6157AT *	ZF Lifeguard Fluid 6
BMW	X3 (E83)	3.0 d; 3.0 sd; xDrive 30 d; xDrive 35 d	gen-04	ago-11	6	AB6163AT	-	ZF Lifeguard Fluid 6
BMW	X3 (F25)	sDrive 18 d; sDrive 20 i; xDrive 20 d; xDrive 20 i; xDrive 28 i; xDrive 30 d; xDrive 35 d; xDrive 35 i	set-10	ago-17	8	AB6164AT	-	ZF Lifeguard Fluid 8
BMW	X3 (G01, F97)	M; M Competition	mar-19	In produzione	8	AB6173AT	-	ZF Lifeguard Fluid 8
BMW	X3 (G01, F97)	M; M Competition; sDrive 18 d; sDrive 18 d Mild-Hybrid; sDrive 20 i; sDrive 20 i 1.6; xDrive 20 d; xDrive 20 d Mild-Hybrid; xDrive 20 i; xDrive 20 i Mild Hybrid; xDrive 25 d; xDrive 30 d; xDrive 30 d Mild-Hybrid; xDrive 30 e Plug-in-Hybrid; xDrive 30 i; xDrive 30 i Mild Hybrid; xDrive M40 d; xDrive M40 d Mild-Hybrid; xDrive M40 i; xDrive M40 i Mild Hybrid	ago-17	In produzione	8	AB6164AT	-	ZF Lifeguard Fluid 8
BMW	X3 (G01, F97)	xDrive 30 e Plug-in-Hybrid	dic-19	In produzione	8	AB6172AT	-	ZF Lifeguard Fluid 8
BMW	X3 Van (G01)	sDrive 18 d; xDrive 30 d; xDrive 30 i; xDrive M40 i	ago-17	In produzione	8	AB6164AT	-	ZF Lifeguard Fluid 8
BMW	X4 (F26)	M 40 i; xDrive 20 d; xDrive 20 i; xDrive 28 i; xDrive 30 d; xDrive 35 d; xDrive 35 i	apr-14	mar-18	8	AB6164AT	-	ZF Lifeguard Fluid 8
BMW	X4 (G02, F98)	M; M Competition; xDrive 20 d; xDrive 20 d Mild-Hybrid; xDrive 20 i; xDrive 20 i Mild Hybrid; xDrive 25 d; xDrive 30 d; xDrive 30 d Mild-Hybrid; xDrive 30 i; xDrive 30 i Mild Hybrid; xDrive M40 d; xDrive M40 d Mild-Hybrid; xDrive M40 i; xDrive M40 i Mild Hybrid	apr-18	In produzione	8	AB6164AT	-	ZF Lifeguard Fluid 8
BMW	X5 (E53)	3.0 d; 3.0 i	apr-00	ott-06	5	AB6046AT	-	GM - DEXRON VI ZF - LIFEGUARD 5
BMW	X5 (E53)	3.0 d; 4.4 i; 4.8 is	ott-03	ott-06	6	AB6156AT *	AB6157AT *	ZF Lifeguard Fluid 6
BMW	X5 (E70)	3.0 3.0d; 3.0 d; 3.0 sd; 3.0 si; 4.8 i xDrive; M; M 50 d; xDrive 30 d; xDrive 30 i; xDrive 35 d; xDrive 35 i; xDrive 40 d; xDrive 48 i; xDrive 50 i	ott-06	lug-13	8	AB6164AT	-	ZF Lifeguard Fluid 8
BMW	X5 (E70)	3.0 3.0d; 3.0 d; 3.0 sd; 3.0 si; 4.8 i xDrive; M; M 50 d; xDrive 30 d; xDrive 30 i; xDrive 35 d; xDrive 35 i; xDrive 40 d; xDrive 48 i; xDrive 50 i	ott-06	lug-13	6	AB6162AT	-	DEXRON VI
BMW	X5 (E70)	3.0 d; 3.0 sd; 3.0 si; 4.8 i xDrive; M; M 50 d; xDrive 30 d; xDrive 30 i; xDrive 35 d; xDrive 35 i; xDrive 40 d; xDrive 48 i; xDrive 50 i	ott-06	lug-13	6	AB6163AT	-	ZF Lifeguard Fluid 6
BMW	X5 (E70)	4.8 i xDrive; xDrive 50 i	ott-06	lug-13	8	AB6173AT	-	ZF Lifeguard Fluid 8

Marca / Brand:	Modello / Model:	Versioni / Version:	Da anno / From:	Ad anno / To:	Marce / Gears:	Codice AB PARTS		Lubrificante Consigliato
BMW	X5 (E70)	M	lug-09	lug-13	6	AB6156AT *	AB6157AT *	ZF Lifeguard Fluid 6
BMW	X5 (F15, F85)	M; M 50 d; sDrive 25 d; xDrive 25 d; xDrive 28 i; xDrive 30 d; xDrive 35 i; xDrive 40 d; xDrive 40e; xDrive 50 i	ago-13	lug-18	8	AB6164AT	-	ZF Lifeguard Fluid 8
BMW	X5 (F15, F85)	M; xDrive 50 i	ago-13	lug-18	8	AB6173AT	-	ZF Lifeguard Fluid 8
BMW	X5 (F15, F85)	xDrive 40e	ago-15	lug-18	8	AB6172AT	-	ZF Lifeguard Fluid 8
BMW	X5 (G05, F95)	xDrive 25 d; xDrive 30 d; xDrive 40 i; xDrive 50 i	ago-18	mar-23	8	AB6164AT	-	ZF Lifeguard Fluid 8
BMW	X5 (G05, F95)	xDrive 45 e Plug-in-Hybrid	giu-19	mar-23	8	AB6172AT	-	ZF Lifeguard Fluid 8
BMW	X5 Van (G05)	xDrive 30 d; xDrive 40 i	nov-19	mar-23	8	AB6164AT	-	ZF Lifeguard Fluid 8
BMW	X6 (E71, E72)	ActiveHybrid	gen-09	ott-11	8	AB6171AT	-	ZF Lifeguard Fluid 8
BMW	X6 (E71, E72)	ActiveHybrid; M; M 50 d; xDrive 30 d; xDrive 35 d; xDrive 35 i; xDrive 40 d; xDrive 50 i	giu-07	lug-14	8	AB6164AT	-	ZF Lifeguard Fluid 8
BMW	X6 (E71, E72)	ActiveHybrid; M; M 50 d; xDrive 30 d; xDrive 35 d; xDrive 35 i; xDrive 40 d; xDrive 50 i	giu-07	lug-14	6	AB6162AT	-	DEXRON VI
BMW	X6 (E71, E72)	M	lug-09	lug-14	6	AB6156AT *	AB6157AT *	ZF Lifeguard Fluid 6
BMW	X6 (E71, E72)	M; xDrive 30 d; xDrive 35 d; xDrive 50 i	gen-08	lug-14	6	AB6163AT	-	ZF Lifeguard Fluid 6
BMW	X6 (E71, E72)	xDrive 50 i	ott-07	lug-14	8	AB6173AT	-	ZF Lifeguard Fluid 8
BMW	X6 (F16, F86)	M	dic-14	lug-19	8	AB6173AT	-	ZF Lifeguard Fluid 8
BMW	X6 (F16, F86)	M; M 50 d; xDrive 30 d; xDrive 35 i; xDrive 40 d; xDrive 50 i	ago-14	lug-19	8	AB6164AT	-	ZF Lifeguard Fluid 8
BMW	X6 (G06, F96)	xDrive 40 i; xDrive M 50 d	ago-19	mar-23	8	AB6164AT	-	ZF Lifeguard Fluid 8
BMW	X7 (G07)	xDrive 30 d; xDrive 40 d Mild-Hybrid; xDrive 40 i; xDrive 40 i Mild-Hybrid; xDrive M 50 d; xDrive M 50 i; xDrive M 60 i Mild-Hybrid	mar-19	In produzione	8	AB6164AT	-	ZF Lifeguard Fluid 8
BMW	Z3 Coupé (E36)	2.8 i; 3.0 i; M	gen-98	giu-03	4	AB6043AT	-	DEXRON III o DEXRON VI
BMW	Z3 Coupé (E36)	3.0 i	giu-00	giu-03	5	AB6046AT	-	GM - DEXRON VI ZF - LIFEGUARD 5
BMW	Z3 Coupé (E36)	3.0 i	giu-00	giu-03	5	AB6047AT	-	GM - DEXRON VI ZF - LIFEGUARD 5
BMW	Z3 Coupé (E36)	3.0 i	giu-00	giu-03	5	AB6048AT	-	GM - DEXRON VI ZF - LIFEGUARD 5
BMW	Z3 Roadster (E36)	1.8 i; 1.9 i; 2.0 i; 2.2 i; 2.8 i; 3.0 i; M 3.2	ott-95	gen-03	4	AB6043AT	-	DEXRON III o DEXRON VI
BMW	Z3 Roadster (E36)	2.2 i; 3.0 i	giu-00	gen-03	5	AB6046AT	-	GM - DEXRON VI ZF - LIFEGUARD 5
BMW	Z3 Roadster (E36)	2.2 i; 3.0 i	giu-00	gen-03	5	AB6047AT	-	GM - DEXRON VI ZF - LIFEGUARD 5
BMW	Z3 Roadster (E36)	2.2 i; 3.0 i	giu-00	gen-03	5	AB6048AT	-	GM - DEXRON VI ZF - LIFEGUARD 5
BMW	Z3 Roadster (E36)	3.2 i; M 3.2	feb-98	dic-02	5	AB6148AT	-	Mobil LT 71141
BMW	Z4 Coupé (E86)	3.0 si; M	apr-06	ago-08	6	AB6162AT	-	DEXRON VI
BMW	Z4 Coupé (E86)	M	apr-06	ago-08	8	AB6173AT	-	ZF Lifeguard Fluid 8
BMW	Z4 Roadster (E85)	2.0 i; 2.2 i; 2.5 i; 2.5 si; 3.0 i; 3.0 si; M	dic-02	feb-09	6	AB6162AT	-	DEXRON VI
BMW	Z4 Roadster (E85)	2.2 i; 2.5 i; 3.0 i	dic-02	dic-05	5	AB6150AT	-	ESSO LT 71141
BMW	Z4 Roadster (E85)	M	gen-06	ago-08	8	AB6173AT	-	ZF Lifeguard Fluid 8
BMW	Z4 Roadster (E89)	sDrive 18 i; sDrive 20 i; sDrive 23 i; sDrive 28 i; sDrive 30 i; sDrive 35 i; sDrive 35 is	feb-09	ago-16	6	AB6162AT	-	DEXRON VI
BMW	Z4 Roadster (E89)	sDrive 18 i; sDrive 20 i; sDrive 28 i	set-11	ago-16	8	AB6164AT	-	ZF Lifeguard Fluid 8
BMW	Z4 Roadster (E89)	sDrive 35 i; sDrive 35 is	feb-09	ago-16	7	AB6014AT + AB6015AT	-	BMW DCTF +1

Marca / Brand:	Modello / Model:	Versioni / Version:	Da anno / From:	Ad anno / To:	Marce / Gears:	Codice AB PARTS		Lubrificante Consigliato
BMW	Z4 Roadster (G29)	M40 i; sDrive 20 i; sDrive 30 i	nov-18	In produzione	8	AB6164AT	-	ZF Lifeguard Fluid 8
CADILLAC	XT4	2.0; 2.0 AWD	mar-18	In produzione	8 / 9	AB6039AT + AB6040AT	-	DEXRON HP
CADILLAC	XT5	2.0 T AWD; 3.6; 3.6 AWD	mag-16	In produzione	8 / 9	AB6039AT + AB6040AT	-	DEXRON HP
CHEVROLET	AVEO / KALOS Hatchback (T200)	1.2; 1.4 16V; 1.5	mag-03	mag-08	6	AB6052AT	-	DEXRON VI
CHEVROLET	AVEO / KALOS Hatchback (T200)	1.4 16V	mag-03	mag-08	4	AB6001AT	-	AISIN JWS 3309
CHEVROLET	AVEO / KALOS Hatchback (T250, T255)	1.4; 1.4 16V	giu-06	In produzione	6	AB6052AT	-	DEXRON VI
CHEVROLET	AVEO / KALOS Hatchback (T250, T255)	1.4; 1.4 16V	giu-06	In produzione	4	AB6001AT	-	AISIN JWS 3309
CHEVROLET	AVEO / KALOS Tre volumi (T200)	1.4	mag-03	mag-08	4	AB6001AT	-	AISIN JWS 3309
CHEVROLET	AVEO / KALOS Tre volumi (T200)	1.4; 1.5	mag-03	mag-08	6	AB6052AT	-	DEXRON VI
CHEVROLET	AVEO / KALOS Tre volumi (T250, T255)	1.4	mar-05	In produzione	4	AB6001AT	-	AISIN JWS 3309
CHEVROLET	AVEO / KALOS Tre volumi (T250, T255)	1.4; 1.5	mar-05	In produzione	6	AB6052AT	-	DEXRON VI
CHEVROLET	AVEO Hatchback (T300)	1.4; 1.6	mar-11	In produzione	6	AB6051AT	-	DEXRON VI
CHEVROLET	AVEO Hatchback (T300)	1.4; 1.6	mar-11	In produzione	6	AB6052AT	-	DEXRON VI
CHEVROLET	AVEO Hatchback (T300)	1.6	mar-11	In produzione	4	AB6001AT	-	AISIN JWS 3309
CHEVROLET	AVEO Tre volumi (T300)	1.4; 1.6	mar-11	In produzione	6	AB6051AT	-	DEXRON VI
CHEVROLET	AVEO Tre volumi (T300)	1.4; 1.6	mar-11	In produzione	6	AB6052AT	-	DEXRON VI
CHEVROLET	AVEO Tre volumi (T300)	1.6	mar-11	In produzione	4	AB6001AT	-	AISIN JWS 3309
CHEVROLET	COBALT	1.5	gen-13	In produzione	6	AB6051AT	-	DEXRON VI
CHEVROLET	CRUZE Hatchback (J305)	1.6; 1.8	giu-11	In produzione	6	AB6051AT	-	DEXRON VI
CHEVROLET	CRUZE Hatchback (J305)	1.6; 2.0 CDI	giu-11	In produzione	6	AB6052AT	-	DEXRON VI
CHEVROLET	CRUZE Station Wagon (J308)	1.8	ago-12	In produzione	6	AB6051AT	-	DEXRON VI
CHEVROLET	EPICA (KL1_)	2.0; 2.0 D; 2.5	gen-05	dic-11	6	AB6052AT	-	DEXRON VI
CHEVROLET	LACETTI (J200)	1.8	mar-05	In produzione	4	AB6001AT	-	AISIN JWS 3309
CHEVROLET	LACETTI Familiare (J200)	1.8	ago-05	In produzione	4	AB6001AT	-	AISIN JWS 3309
CHEVROLET	LACETTI Tre volumi (J200)	1.6	mar-05	mar-13	4	AB6001AT	-	AISIN JWS 3309
CHEVROLET	MALIBU	3.7	gen-80	dic-83	6	AB6052AT	-	DEXRON VI
CHEVROLET	MALIBU (V300)	2.0 D; 2.4	gen-12	In produzione	6	AB6052AT	-	DEXRON VI
CHEVROLET	NUBIRA Familiare	1.8	mar-05	dic-11	4	AB6001AT	-	AISIN JWS 3309
CHEVROLET	NUBIRA Tre volumi	1.8	mar-05	dic-09	4	AB6001AT	-	AISIN JWS 3309
CHEVROLET	OPTRA (1J_)	1.6; 1.8	ago-03	dic-08	4	AB6001AT	-	AISIN JWS 3309
CHEVROLET	ORLANDO (J309)	2.0 D	feb-11	In produzione	6	AB6052AT	-	DEXRON VI
CHEVROLET	TRAILBLAZER	1.3; 1.3 AWD	set-21	In produzione	CVT	AB6053AT + AB6054AT	-	OPEL 95529854
CHEVROLET	TRAVERSE	3.6 AWD	lug-17	In produzione	8 / 9	AB6039AT + AB6040AT	-	DEXRON HP
CHEVROLET	TRAX	1.4; 1.7 TD; 1.8; 1.8 AWD	dic-12	In produzione	6	AB6052AT	-	DEXRON VI
CHRYSLER	300C (LX)	3.0 CRD; 3.6	lug-11	In produzione	8	AB6164AT	-	ZF Lifeguard Fluid 8
CHRYSLER	300C (LX)	3.0 CRD; 3.6; 6.4	gen-11	In produzione	5	AB6078AT	-	MB 236.14

Marca / Brand:	Modello / Model:	Versioni / Version:	Da anno / From:	Ad anno / To:	Marce / Gears:	Codice AB PARTS		Lubrificante Consigliato
CHRYSLER	300C (LX, LE)	2.7	set-04	nov-12	4	AB6019AT	-	MOPAR ATF +4
CHRYSLER	300C (LX, LE)	2.7; 3.0 CRD; 3.0 V6 CRD; 3.5; 3.5 AWD; 5.7; 6.1 SRT8	set-04	nov-12	8	AB6164AT	-	ZF Lifeguard Fluid 8
CHRYSLER	300C (LX, LE)	2.7; 3.0 CRD; 3.0 V6 CRD; 3.5; 3.5 AWD; 5.7; 6.1 SRT8	set-04	nov-12	5	AB6078AT	-	MB 236.14
CHRYSLER	300C Touring (LX, LE)	2.7	set-04	dic-10	4	AB6019AT	-	MOPAR ATF +4
CHRYSLER	300C Touring (LX, LE)	2.7; 3.0 CRD; 3.5; 3.5 AWD; 5.7; 5.7 AWD; 6.1 SRT8	set-04	dic-10	8	AB6164AT	-	ZF Lifeguard Fluid 8
CHRYSLER	300C Touring (LX, LE)	2.7; 3.0 CRD; 3.5; 3.5 AWD; 5.7; 5.7 AWD; 6.1 SRT8	set-04	dic-10	5	AB6078AT	-	MB 236.14
CHRYSLER	CROSSFIRE	3.2; SRT-6	lug-03	dic-08	5	AB6078AT	-	MB 236.14
CHRYSLER	CROSSFIRE Roadster	3.2; SRT-6	mag-04	dic-08	5	AB6078AT	-	MB 236.14
CHRYSLER	GRAND VOYAGER V (RT)	2.8 CRD; 3.3; 3.6; 3.6 Flexfuel; 3.8; 4.0	ott-07	In produzione	6	AB6022AT	-	MOPAR ATF +4
CITROEN	C3 I (FC_, FN_)	1.1 i; 1.4 BiFuel; 1.4 i; 1.4 i Bivalent; 1.6 16V	feb-02	nov-10	4	AB6101AT	-	PSA 97.36.22
CITROEN	C4 Coupé (LA_)	1.6 16V; 1.6 THP; 1.6 THP 150; 1.6 VTi 120; 2.0 16V; 2.0 VTR	nov-04	lug-11	4	AB6101AT	-	PSA 97.36.22
CITROEN	C4 GRAND PICASSO I (UA_)	1.6 16V; 2.0 i 16V	ott-06	dic-13	4	AB6101AT	-	PSA 97.36.22
CITROEN	C4 I (LC_)	1.6 16V; 1.6 16V Bio-Flex; 1.6 THP 140; 1.6 THP 150; 1.6 VTi 120; 2.0 16V	nov-04	lug-11	4	AB6101AT	-	PSA 97.36.22
CITROEN	C4 I Tre volumi	1.6 16V; 2.0 16V	lug-06	lug-11	4	AB6101AT	-	PSA 97.36.22
CITROEN	C4 II (NC_)	1.6 VTi 120; 1.6 VTi 120 LPG	nov-09	In produzione	4	AB6101AT	-	PSA 97.36.22
CITROEN	C4 PICASSO I MPV / Space wagon (UD_)	1.6 16V; 1.6 THP 140; 2.0 i 16V	set-07	ago-13	4	AB6101AT	-	PSA 97.36.22
CITROEN	C5 I (DC_)	1.8 16V; 2.0 16V; 2.0 16V HPI; 2.0 HDi	mar-01	ago-04	4	AB6101AT	-	PSA 97.36.22
CITROEN	C5 I (DC_)	1.8 16V; 2.0 16V; 2.0 16V HPI; 2.0 HDi; 2.2 HDi; 3.0 V6	mar-01	ago-04	4	AB6143AT	-	ESSO LT 71141
CITROEN	C5 I Break (DE_)	1.8 16V; 2.0 16V; 2.0 16V HPI; 2.0 HDi	giu-01	ago-04	4	AB6101AT	-	PSA 97.36.22
CITROEN	C5 I Break (DE_)	1.8 16V; 2.0 16V; 2.0 16V HPI; 2.0 HDi; 2.2 HDi; 3.0 Carlsson; 3.0 V6	giu-01	ago-04	4	AB6143AT	-	ESSO LT 71141
CITROEN	C5 I Furgone/familiare (DE_)	1.6 HDi; 1.8 16V; 2.0 16V; 2.0 HDi; 2.2 HDi	giu-02	gen-08	4	AB6143AT	-	ESSO LT 71141
CITROEN	C5 I Furgone/familiare (DE_)	1.8 16V; 2.0 16V; 2.0 HDi	giu-02	gen-08	4	AB6101AT	-	PSA 97.36.22
CITROEN	C5 II (RC_)	1.6 HDi; 1.8 16V; 2.0 16V; 2.0 HDi; 2.2 HDi; 3.0 V6	set-04	set-08	4	AB6143AT	-	ESSO LT 71141
CITROEN	C5 II (RC_)	1.8 16V; 2.0 16V	set-04	ago-08	4	AB6101AT	-	PSA 97.36.22
CITROEN	C5 II Break (RE_)	1.6 HDi; 1.8 16V; 2.0 16V; 2.0 HDi; 2.2 HDi; 3.0; 3.0 V6	set-04	ago-08	4	AB6143AT	-	ESSO LT 71141
CITROEN	C5 II Break (RE_)	1.8 16V; 2.0 16V	set-04	gen-08	4	AB6101AT	-	PSA 97.36.22
CITROEN	C5 III (RD_)	2.0 16V; 2.0 16V BioFlex	feb-08	ott-14	4	AB6101AT	-	PSA 97.36.22
CITROEN	C5 III (RD_)	2.2 HDi; 3.0 V6	feb-08	dic-11	4	AB6143AT	-	ESSO LT 71141
CITROEN	C5 III Break (RW_)	2.0 16V BioFlex; 2.0 i 16V	feb-08	ott-14	4	AB6101AT	-	PSA 97.36.22
CITROEN	C5 III Break (RW_)	2.2 HDi 165; 3.0 V6	feb-08	dic-10	4	AB6143AT	-	ESSO LT 71141
CITROEN	C8 (EA_, EB_)	2.0; 2.0 16V; 2.0 HDi	lug-02	In produzione	4	AB6101AT	-	PSA 97.36.22
CITROEN	C8 (EA_, EB_)	3.0 V6	lug-02	In produzione	4	AB6143AT	-	ESSO LT 71141
CITROEN	C8 Van (EA_, EB_)	2.0; HDi 110	nov-03	dic-11	4	AB6101AT	-	PSA 97.36.22
CITROEN	C8 Van (EA_, EB_)	3.0	nov-03	ott-07	4	AB6143AT	-	ESSO LT 71141
CITROEN	C-ELYSEE (DD_)	1.6 VTi 115	nov-12	In produzione	4	AB6101AT	-	PSA 97.36.22
CITROEN	DS3 (SA_)	1.6 VTi 120	apr-10	lug-15	4	AB6101AT	-	PSA 97.36.22
CITROEN	DS3 Cabriolet	1.6 VTi 120	gen-13	lug-15	4	AB6101AT	-	PSA 97.36.22
CITROEN	DS4 (NX_)	1.6 VTi 120	apr-11	lug-15	4	AB6101AT	-	PSA 97.36.22
CITROEN	EVASION MPV / Space wagon (22, U6)	1.8; 1.9 TD; 2.0; 2.0 16V; 2.0 HDi; 2.0 HDi 16V; 2.0 Turbo C.T.; 2.1 TD	giu-94	lug-02	4	AB6101AT	-	PSA 97.36.22
CITROEN	EVASION Van (U6_, AF_)	2.0; DT; HDi; TD	nov-94	ott-02	4	AB6101AT	-	PSA 97.36.22

Marca / Brand:	Modello / Model:	Versioni / Version:	Da anno / From:	Ad anno / To:	Marce / Gears:	Codice AB PARTS		Lubrificante Consigliato
CITROEN	JUMPY I (U6U_)	2.0; 2.0 i 16V	mar-00	dic-06	4	AB6101AT	-	PSA 97.36.22
CITROEN	JUMPY I Furgone (BS_, BT_, BY_, BZ_)	2.0; 2.0 i 16V	mar-00	ott-06	4	AB6101AT	-	PSA 97.36.22
CITROEN	JUMPY I Pianale piatto/Telaio (BU_, BV_, BW_, BX_)	2.0	dic-03	ott-06	4	AB6101AT	-	PSA 97.36.22
CITROEN	XANTIA (X1_, X2_)	1.8 i 16V; 1.9 Turbo D; 2.0 i 16V	mar-93	apr-03	4	AB6101AT	-	PSA 97.36.22
CITROEN	XANTIA (X1_, X2_)	3.0 i 24V	gen-97	apr-03	4	AB6143AT	-	ESSO LT 71141
CITROEN	XANTIA Break (X1_, X2_)	1.8 i 16V; 1.9 Turbo D; 2.0 i 16V	giu-95	apr-03	4	AB6101AT	-	PSA 97.36.22
CITROEN	XANTIA Break (X1_, X2_)	3.0 V6	gen-98	apr-03	4	AB6143AT	-	ESSO LT 71141
CITROEN	XANTIA Furgone/familiare (X2_)	1.9 DT	dic-97	dic-00	4	AB6101AT	-	PSA 97.36.22
CITROEN	XM (Y3)	3.0; 3.0 V6; 3.0 V6 24V	mag-89	giu-94	4	AB6143AT	-	ESSO LT 71141
CITROEN	XM (Y4)	3.0 V6; 3.0 V6 24V	mag-94	ott-00	4	AB6143AT	-	ESSO LT 71141
CITROEN	XM Break (Y3)	3.0; 3.0 Pullman; 3.0 V6; 3.0 V6 24V	mag-89	lug-94	4	AB6143AT	-	ESSO LT 71141
CITROEN	XM Break (Y4)	3.0 V6	mag-94	ott-00	4	AB6143AT	-	ESSO LT 71141
CITROEN	XSARA (N1)	1.6 16V; 1.6 i; 2.0 16V; 2.0 HDi 109	apr-97	mar-05	4	AB6101AT	-	PSA 97.36.22
CITROEN	XSARA Break (N2)	1.6 16V; 1.6 i; 2.0 16V; 2.0 HDi 109	ott-97	ago-05	4	AB6101AT	-	PSA 97.36.22
CITROEN	XSARA Coupé (N0)	1.6 16V; 1.6 i; 2.0 16V; 2.0 HDi 109	feb-98	mar-05	4	AB6101AT	-	PSA 97.36.22
CITROEN	XSARA PICASSO (N68)	2.0 16V	dic-99	giu-12	4	AB6101AT	-	PSA 97.36.22
CUPRA	ATECA (KH7, KHP, KBP)	1.5 TSI; 2.0 TSI 4Drive	set-18	In produzione	7	AB6024AT	-	Meccatronica: VW G004000 Cambio: VW G052171
DACIA	DUSTER (HM_)	1.5 dCi 110	ott-17	In produzione	CVT	AB6064AT + AB6065AT	-	MITSUBISHI CVTF-J4
DACIA	LOGAN (LS_)	1.6 16V; 1.6 16V Flexifuel	feb-06	In produzione	4	AB6101AT	-	PSA 97.36.22
DACIA	LOGAN MCV (KS_)	1.6 16V; 1.6 16V Hi-Flex	feb-07	In produzione	4	AB6101AT	-	PSA 97.36.22
DACIA	SANDERO	1.6 16V; 1.6 16V Bifuel	gen-11	In produzione	4	AB6101AT	-	PSA 97.36.22
DACIA	SANDERO III	1.0 TCe 90	gen-21	In produzione	CVT	AB6064AT + AB6065AT	-	MITSUBISHI CVTF-J4
DAEWOO	KALOS (KLAS)	1.4 16V	apr-03	In produzione	4	AB6001AT	-	AISIN JWS 3309
DAEWOO	KALOS Tre volumi (KLAS)	1.4	mag-03	dic-04	4	AB6001AT	-	AISIN JWS 3309
DAEWOO	LACETTI Hatchback (KLAN)	1.6	feb-04	In produzione	4	AB6001AT	-	AISIN JWS 3309
DAEWOO	NUBIRA Tre volumi (J200)	1.6	lug-03	In produzione	4	AB6001AT	-	AISIN JWS 3309
DAEWOO	NUBIRA Wagon (J200)	1.6	lug-03	In produzione	4	AB6001AT	-	AISIN JWS 3309
DODGE	AVENGER	2.4; 2.7; 2.7 Flex-Fuel; 3.6	giu-07	dic-14	6	AB6022AT	-	MOPAR ATF +4
DODGE	CHALLENGER Coupé	3.5	set-08	dic-10	4	AB6019AT	-	MOPAR ATF +4
DODGE	CHALLENGER Coupé	3.6	gen-11	In produzione	5	AB6078AT	-	MB 236.14
DODGE	CHARGER	5.7 R/T; 5.7 R/T AWD; 3.6; 5.7 Flexfuel AWD; 6.4 SRT8	set-10	In produzione	5	AB6078AT	-	MB 236.14
DODGE	DURANGO (DN)	4.7; 4.7 4WD; 5.2; 5.2 4WD	set-97	dic-03	4 / 5 / 6	AB6021AT	-	MOPAR ATF +4
DODGE	DURANGO (DN)	5.2; 5.2 4WD	dic-97	dic-00	4	AB6018AT	-	MOPAR ATF +4
DODGE	DURANGO (HB)	3.7; 3.7 AWD; 4.7; 4.7 AWD; 5.7 AWD	nov-03	dic-10	4	AB6019AT	-	MOPAR ATF +4
DODGE	DURANGO (HB)	4.7; 4.7 AWD; 5.7 AWD	nov-03	dic-10	4 / 5 / 6	AB6021AT	-	MOPAR ATF +4
DODGE	DURANGO (WD)	3.6; 3.6 AWD	gen-11	In produzione	5	AB6078AT	-	MB 236.14
DODGE	GRAND CARAVAN	3.3; 3.6; 3.8	giu-07	In produzione	6	AB6022AT	-	MOPAR ATF +4

Marca / Brand:	Modello / Model:	Versioni / Version:	Da anno / From:	Ad anno / To:	Marce / Gears:	Codice AB PARTS		Lubrificante Consigliato
DODGE	JOURNEY	2.4; 2.7; 2.7 FLEXFUEL; 3.5; 3.5 AWD; 3.6; 3.6 AWD	giu-08	In produzione	6	AB6022AT	-	MOPAR ATF +4
DODGE	JOURNEY VAN (JC)	2.4 VVT; 2.7 FlexFuel; 3.6 FlexFuel AWD	gen-09	In produzione	6	AB6022AT	-	MOPAR ATF +4
DODGE	NITRO	2.8 CRD 4WD; 3.7 4WD; 3.7 V6 4WD; 4.0 4WD	set-06	dic-12	4	AB6019AT	-	MOPAR ATF +4
DODGE	NITRO	2.8 CRD; 2.8 CRD 4WD; 4.0 4WD	set-06	dic-12	5	AB6078AT	-	MB 236.14
DODGE	NITRO VAN (KA)	2.8 CRD; 4.0 4WD	set-06	dic-11	5	AB6078AT	-	MB 236.14
DODGE	NITRO VAN (KA)	4.0 4WD	set-06	dic-11	4	AB6019AT	-	MOPAR ATF +4
DODGE	RAM 1500 Crew Cab Pickup	4.7; 5.7; 5.7 4WD	set-01	dic-10	4 / 5 / 6	AB6021AT	-	MOPAR ATF +4
DODGE	RAM 1500 Crew Cab Pickup	8.3 SRT-10	set-04	dic-06	4	AB6018AT	-	MOPAR ATF +4
DODGE	RAM 1500 Extended Crew Cab Pickup	5.7; 5.7 4WD	set-06	dic-08	4 / 5 / 6	AB6021AT	-	MOPAR ATF +4
DODGE	RAM 1500 Pick-up (BE, BR)	5.9; 5.9 4x4	gen-93	set-01	4	AB6018AT	-	MOPAR ATF +4
DODGE	RAM 1500 Pick-up (D1, DC, DH, DM, DR)	3.7	giu-01	set-08	4	AB6019AT	-	MOPAR ATF +4
DODGE	RAM 1500 Pick-up (D1, DC, DH, DM, DR)	4.7; 4.7 4x4; 5.7	giu-01	set-08	4 / 5 / 6	AB6021AT	-	MOPAR ATF +4
DODGE	RAM 1500 Standard Cab Pickup	4.7; 4.7 4WD; 5.7; 5.7 4WD	set-01	dic-10	4 / 5 / 6	AB6021AT	-	MOPAR ATF +4
DODGE	RAM 2500 Cab & Chassis	5.7; 5.7 4WD	set-02	dic-05	4 / 5 / 6	AB6021AT	-	MOPAR ATF +4
DODGE	RAM 2500 Crew Cab Pickup	5.7; 5.7 4WD	set-02	dic-08	4 / 5 / 6	AB6021AT	-	MOPAR ATF +4
DODGE	RAM 2500 Crew Cab Pickup (DJ)	5.7; 5.7 4WD	set-09	dic-10	4 / 5 / 6	AB6021AT	-	MOPAR ATF +4
DODGE	RAM 2500 Extended Crew Cab Pickup	5.7; 5.7 4WD	set-05	dic-08	4 / 5 / 6	AB6021AT	-	MOPAR ATF +4
DODGE	RAM 2500 Pick-up (BE, BR)	5.9; 5.9 4x4	gen-93	set-01	4	AB6018AT	-	MOPAR ATF +4
DODGE	RAM 2500 Pick-up (D1, DC, DH, DM, DR)	5.7; 5.7 4x4	gen-02	dic-09	4 / 5 / 6	AB6021AT	-	MOPAR ATF +4
DODGE	RAM 2500 Pick-up (DJ, DS)	5.7; 5.7 4x4	gen-09	In produzione	8	AB6170AT	-	ZF Lifeguard Fluid 8
DODGE	RAM 2500 Standard Cab Pickup	5.7; 5.7 4WD	set-02	dic-08	4 / 5 / 6	AB6021AT	-	MOPAR ATF +4
DODGE	RAM 2500 Standard Cab Pickup (DJ)	5.7	set-09	dic-10	4 / 5 / 6	AB6021AT	-	MOPAR ATF +4
DODGE	RAM 3500 Pick-up (BR, BE)	5.9	gen-93	mag-01	4	AB6018AT	-	MOPAR ATF +4
DODGE	RAM 3500 Pick-up (DR, DH, D1, DC, DM)	5.7; 5.7 4x4	gen-02	dic-08	4 / 5 / 6	AB6021AT	-	MOPAR ATF +4
DS	DS 3 (SA_)	1.6 THP; 1.6 THP 165	lug-15	lug-19	4	AB6101AT	-	PSA 97.36.22
DS	DS 3 Cabriolet (SB_)	1.6 THP; 1.6 THP 165	lug-15	lug-19	4	AB6101AT	-	PSA 97.36.22
FIAT	FREEMONT (345_)	3.6; 3.6 4x4	ago-11	dic-16	6	AB6022AT	-	MOPAR ATF +4
FIAT	FULLBACK Pick-up (502_, 503_)	2.4 D 4x4	apr-16	In produzione	5	AB6122AT	-	Toyota ATF WS
FORD	C-MAX (DM2)	1.6; 1.6 TDCi; 1.8; 1.8 Flexifuel; 1.8 TDCi; 2.0; 2.0 CNG; 2.0 LPG; 2.0 TDCi	feb-07	set-10	6	AB6098AT + AB6100AT *	AB6099AT *	FORD 1490763
FORD	C-MAX (DM2)	1.6; 1.6 TDCi; 1.8; 1.8 Flexifuel; 1.8 TDCi; 2.0; 2.0 CNG; 2.0 LPG; 2.0 TDCi	feb-07	set-10	4	AB6033AT	-	MERCON V
FORD	C-MAX (DM2)	1.6; 1.6 TDCi; 1.8; 1.8 Flexifuel; 1.8 TDCi; 2.0; 2.0 CNG; 2.0 LPG; 2.0 TDCi	feb-07	set-10	4 / 5	AB6034AT	-	MERCON V
FORD	C-MAX (DM2)	1.8; 2.0; 2.0 TDCi	feb-07	set-10	6	AB6098AT + AB6100AT *	AB6099AT *	FORD 1490763
FORD	C-MAX II (DXA/CB7, DXA/CEU)	1.0 EcoBoost; 1.5 EcoBoost; 1.5 TDCi; 1.5 TDCi ECONetic; 1.6 EcoBoost; 1.6 Flexifuel; 1.6 LPG; 1.6 TDCi; 1.6 Ti; 2.0 Energi; 2.0 TDCi	apr-10	giu-19	6	AB6098AT + AB6100AT *	AB6099AT *	FORD 1490763
FORD	C-MAX II (DXA/CB7, DXA/CEU)	1.5 EcoBoost; 1.5 TDCi; 2.0 Energi; 2.0 TDCi	apr-10	giu-19	6	AB6098AT + AB6100AT *	AB6099AT *	FORD 1490763

Marca / Brand:	Modello / Model:	Versioni / Version:	Da anno / From:	Ad anno / To:	Marce / Gears:	Codice AB PARTS		Lubrificante Consigliato
FORD	C-MAX II Van	1.0 EcoBoost; 1.5 EcoBoost; 1.5 TDCi ECOnetic; 1.6 EcoBoost; 1.6 TDCi; 1.6 Ti; 2.0 TDCi	ott-10	giu-19	6	AB6098AT + AB6100AT *	- AB6099AT *	FORD 1490763
FORD	C-MAX II Van	1.5 EcoBoost; 2.0 TDCi	dic-10	giu-19	6	AB6098AT + AB6100AT *	- AB6099AT *	FORD 1490763
FORD	EDGE	2.0 EcoBlue, 2.0 EcoBlue AWD	ago-18	In produzione	8	AB6035AT + AB6036AT	-	FORD WSS-M2C949-A
FORD	FIESTA Tre volumi	1.6 Ti	apr-10	apr-17	4	AB6033AT	-	MERCON V
FORD	FIESTA VI (CB1, CCN)	1.25; 1.4; 1.4 LPG; 1.4 TDCi; 1.6 TDCi; 1.6 Ti	giu-08	apr-17	4	AB6033AT	-	MERCON V
FORD	FIESTA VI (CB1, CCN)	1.25; 1.4; 1.4 LPG; 1.4 TDCi; 1.6 TDCi; 1.6 Ti	giu-08	apr-17	4 / 5	AB6034AT	-	MERCON V
FORD	FIESTA VI Van	1.25; 1.4; 1.4 TDCi; 1.6 TDCi; 1.6 Ti-VCT	ago-08	apr-17	4	AB6033AT	-	MERCON V
FORD	FIESTA VI Van	1.4	ott-08	dic-12	4 / 5	AB6034AT	-	MERCON V
FORD	FOCUS C-MAX (DM2)	1.6; 1.6 TDCi; 1.6 Ti; 1.8; 1.8 Flexifuel; 1.8 TDCi; 2.0; 2.0 TDCi	ott-03	mar-07	CVT	AB6037AT + AB6038AT	-	FORD ATF F-CVT
FORD	FOCUS C-MAX (DM2)	1.6; 1.6 TDCi; 1.6 Ti; 1.8; 1.8 Flexifuel; 1.8 TDCi; 2.0; 2.0 TDCi	ott-03	mar-07	4	AB6033AT	-	MERCON V
FORD	FOCUS C-MAX (DM2)	1.6; 1.6 TDCi; 1.6 Ti; 1.8; 1.8 Flexifuel; 1.8 TDCi; 2.0; 2.0 TDCi	ott-03	mar-07	4 / 5	AB6034AT	-	MERCON V
FORD	FOCUS I (DAW, DBW)	1.8 DI; 1.8 Turbo DI; 1.4 16V; 1.6 16V; 1.6 16V Flexifuel; 1.8 16V; 1.8 TDCi; 2.0 16V; RS; ST170	ott-98	nov-04	4	AB6033AT	-	MERCON V
FORD	FOCUS I (DAW, DBW)	1.8 DI; 1.8 Turbo DI; 1.4 16V; 1.6 16V; 1.6 16V Flexifuel; 1.8 16V; 1.8 TDCi; 2.0 16V; RS; ST170	ott-98	nov-04	4 / 5	AB6034AT	-	MERCON V
FORD	FOCUS I Furgone/familiare (DNW)	1.4; 1.6; 1.8; 1.8 TDCi; 1.8 TDDi	ago-98	mar-05	4	AB6033AT	-	MERCON V
FORD	FOCUS I Tre volumi (DFW)	1.8 Turbo DI; 1.4 16V; 1.6 16V; 1.8 16V; 1.8 TDCi; 2.0 16V	feb-99	mar-05	4	AB6033AT	-	MERCON V
FORD	FOCUS I Tre volumi (DFW)	2.0 16V	feb-99	nov-04	4 / 5	AB6034AT	-	MERCON V
FORD	FOCUS I Turnier (DNW)	1.8 DI; 1.8 Turbo DI; 1.4 16V; 1.6 16V; 1.8 16V; 1.8 TDCi; 2.0 16V; ST170	feb-99	nov-04	4	AB6033AT	-	MERCON V
FORD	FOCUS II (DA_, HCP, DP)	1.4; 1.6; 1.6 LPG; 1.6 TDCi; 1.6 Ti; 1.8; 1.8 Flexifuel; 1.8 TDCi; 2.0; 2.0 CNG; 2.0 LPG; 2.0 TDCi; 2.5 RS; 2.5 RS 500; 2.5 ST	lug-04	set-12	6	AB6098AT + AB6100AT *	- AB6099AT *	FORD 1490763
FORD	FOCUS II (DA_, HCP, DP)	1.4; 1.6; 1.6 LPG; 1.6 TDCi; 1.6 Ti; 1.8; 1.8 Flexifuel; 1.8 TDCi; 2.0; 2.0 CNG; 2.0 LPG; 2.0 TDCi; 2.5 RS; 2.5 RS 500; 2.5 ST	lug-04	set-12	CVT	AB6037AT + AB6038AT	-	FORD ATF F-CVT
FORD	FOCUS II (DA_, HCP, DP)	1.4; 1.6; 1.6 LPG; 1.6 TDCi; 1.6 Ti; 1.8; 1.8 Flexifuel; 1.8 TDCi; 2.0; 2.0 CNG; 2.0 LPG; 2.0 TDCi; 2.5 RS; 2.5 RS 500; 2.5 ST	lug-04	set-12	4	AB6033AT	-	MERCON V
FORD	FOCUS II (DA_, HCP, DP)	1.4; 1.6; 1.6 LPG; 1.6 TDCi; 1.6 Ti; 1.8; 1.8 Flexifuel; 1.8 TDCi; 2.0; 2.0 CNG; 2.0 LPG; 2.0 TDCi; 2.5 RS; 2.5 RS 500; 2.5 ST	lug-04	set-12	4 / 5	AB6034AT	-	MERCON V
FORD	FOCUS II (DA_, HCP, DP)	1.6; 2.0; 2.0 CNG; 2.0 TDCi	lug-04	set-12	6	AB6098AT + AB6100AT *	- AB6099AT *	FORD 1490763
FORD	FOCUS II Cabriolet	1.6; 2.0; 2.0 TDCi	ott-06	set-10	6	AB6098AT + AB6100AT *	- AB6099AT *	FORD 1490763
FORD	FOCUS II Cabriolet	1.6; 2.0; 2.0 TDCi	ott-06	set-10	CVT	AB6037AT + AB6038AT	-	FORD ATF F-CVT
FORD	FOCUS II Cabriolet	1.6; 2.0; 2.0 TDCi	ott-06	set-10	4	AB6033AT	-	MERCON V
FORD	FOCUS II Cabriolet	1.6; 2.0; 2.0 TDCi	ott-06	set-10	4 / 5	AB6034AT	-	MERCON V
FORD	FOCUS II Furgone/familiare	1.4; 1.6; 1.6 TDCi; 1.6 Ti-VCT; 2.0 TDCi	lug-04	lug-11	6	AB6098AT + AB6100AT *	- AB6099AT *	FORD 1490763

Marca / Brand:	Modello / Model:	Versioni / Version:	Da anno / From :	Ad anno / To :	Marce / Gears:	Codice AB PARTS		Lubrificante Consigliato
FORD	FOCUS II Furgone/familiare	1.4; 1.6; 1.6 TDCi; 1.6 Ti-VCT; 2.0 TDCi	lug-04	lug-11	CVT	AB6037AT + AB6038AT	-	FORD ATF F-CVT
FORD	FOCUS II Furgone/familiare	1.4; 1.6; 1.6 TDCi; 1.6 Ti-VCT; 2.0 TDCi	lug-04	lug-11	4	AB6033AT	-	MERCON V
FORD	FOCUS II Furgone/familiare	2.0 TDCi	giu-09	lug-11	6	AB6098AT + AB6100AT *	AB6099AT *	FORD 1490763
FORD	FOCUS II Tre volumi (DB_, FCH, DH)	1.4; 1.6; 1.6 TDCi; 1.6 Ti; 1.8; 1.8 Flexifuel; 1.8 TDCi; 2.0; 2.0 TDCi	apr-05	set-12	6	AB6098AT + AB6100AT *	AB6099AT *	FORD 1490763
FORD	FOCUS II Tre volumi (DB_, FCH, DH)	1.4; 1.6; 1.6 TDCi; 1.6 Ti; 1.8; 1.8 Flexifuel; 1.8 TDCi; 2.0; 2.0 TDCi	apr-05	set-12	CVT	AB6037AT + AB6038AT	-	FORD ATF F-CVT
FORD	FOCUS II Tre volumi (DB_, FCH, DH)	1.4; 1.6; 1.6 TDCi; 1.6 Ti; 1.8; 1.8 Flexifuel; 1.8 TDCi; 2.0; 2.0 TDCi	apr-05	set-12	4	AB6033AT	-	MERCON V
FORD	FOCUS II Tre volumi (DB_, FCH, DH)	1.4; 1.6; 1.6 TDCi; 1.6 Ti; 1.8; 1.8 Flexifuel; 1.8 TDCi; 2.0; 2.0 TDCi	apr-05	set-12	4 / 5	AB6034AT	-	MERCON V
FORD	FOCUS II Tre volumi (DB_, FCH, DH)	1.6; 1.6 TDCi; 1.8 Flexifuel; 2.0; 2.0 TDCi	apr-05	set-12	6	AB6098AT + AB6100AT *	AB6099AT *	FORD 1490763
FORD	FOCUS II Turnier (DA_, FFS, DS)	1.4; 1.6; 1.6 LPG; 1.6 TDCi; 1.6 Ti; 1.8; 1.8 Flexifuel; 1.8 TDCi; 2.0; 2.0 LPG; 2.0 TDCi	lug-04	set-12	6	AB6098AT + AB6100AT *	AB6099AT *	FORD 1490763
FORD	FOCUS II Turnier (DA_, FFS, DS)	1.4; 1.6; 1.6 LPG; 1.6 TDCi; 1.6 Ti; 1.8; 1.8 Flexifuel; 1.8 TDCi; 2.0; 2.0 LPG; 2.0 TDCi	lug-04	set-12	CVT	AB6037AT + AB6038AT	-	FORD ATF F-CVT
FORD	FOCUS II Turnier (DA_, FFS, DS)	1.4; 1.6; 1.6 LPG; 1.6 TDCi; 1.6 Ti; 1.8; 1.8 Flexifuel; 1.8 TDCi; 2.0; 2.0 LPG; 2.0 TDCi	lug-04	set-12	4	AB6033AT	-	MERCON V
FORD	FOCUS II Turnier (DA_, FFS, DS)	1.4; 1.6; 1.6 LPG; 1.6 TDCi; 1.6 Ti; 1.8; 1.8 Flexifuel; 1.8 TDCi; 2.0; 2.0 LPG; 2.0 TDCi	lug-04	set-12	4 / 5	AB6034AT	-	MERCON V
FORD	FOCUS II Turnier (DA_, FFS, DS)	1.6; 2.0; 2.0 TDCi	lug-04	set-12	6	AB6098AT + AB6100AT *	AB6099AT *	FORD 1490763
FORD	FOCUS III	1.0 EcoBoost; 1.5 EcoBoost; 1.5 TDCi; 1.5 TDCi ECONetic; 1.6 EcoBoost; 1.6 Flexifuel; 1.6 LPG; 1.6 TDCi; 1.6 TDCi ECONetic; 1.6 Ti; 2.0; 2.0 ST; 2.0 TDCi; 2.0 TDCi ST; 2.0 Ti-GDi; Electric	lug-10	feb-20	6	AB6098AT + AB6100AT *	AB6099AT *	FORD 1490763
FORD	FOCUS III	1.0 EcoBoost; 1.5 EcoBoost; 1.5 TDCi; 1.6 Ti; 2.0; 2.0 TDCi; 2.0 TDCi ST; 2.0 Ti-GDi	lug-10	feb-20	6	AB6098AT + AB6100AT *	AB6099AT *	FORD 1490763
FORD	FOCUS III Furgone/familiare	1.0 EcoBoost; 1.5 EcoBoost; 1.5 TDCi; 2.0 TDCi	feb-12	feb-20	6	AB6098AT + AB6100AT *	AB6099AT *	FORD 1490763
FORD	FOCUS III Furgone/familiare	1.0 EcoBoost; 1.5 EcoBoost; 1.5 TDCi; 2.0 TDCi	feb-12	feb-20	6	AB6098AT + AB6100AT *	AB6099AT *	FORD 1490763
FORD	FOCUS III Furgone/hatchback	1.0 EcoBoost; 1.5 EcoBoost; 1.5 TDCi; 1.6 EcoBoost; 1.6 TDCi; 1.6 Ti; 2.0 TDCi	gen-11	feb-20	6	AB6098AT + AB6100AT *	AB6099AT *	FORD 1490763
FORD	FOCUS III Furgone/hatchback	1.0 EcoBoost; 1.5 EcoBoost; 1.5 TDCi; 2.0 TDCi	gen-11	dic-17	6	AB6098AT + AB6100AT *	AB6099AT *	FORD 1490763
FORD	FOCUS III Tre volumi	1.0 EcoBoost; 1.5 EcoBoost; 1.5 TDCi; 1.5 TDCi ECONetic; 1.6 EcoBoost; 1.6 Flexifuel; 1.6 TDCi; 1.6 Ti; 2.0; 2.0 GDi; 2.0 TDCi	lug-10	feb-20	6	AB6098AT + AB6100AT *	AB6099AT *	FORD 1490763
FORD	FOCUS III Tre volumi	1.0 EcoBoost; 1.5 EcoBoost; 1.5 TDCi; 1.6 Ti; 2.0; 2.0 GDi; 2.0 TDCi	lug-10	feb-20	6	AB6098AT + AB6100AT *	AB6099AT *	FORD 1490763
FORD	FOCUS III Turnier	1.0 EcoBoost; 1.5 EcoBoost; 1.5 TDCi; 1.5 TDCi ECONetic; 1.6 EcoBoost; 1.6 Flexifuel; 1.6 LPG; 1.6 TDCi; 1.6 TDCi ECONetic; 1.6 Ti; 2.0; 2.0 ST; 2.0 TDCi; 2.0 TDCi ST; 2.0 Ti-GDi	lug-10	feb-20	6	AB6098AT + AB6100AT *	AB6099AT *	FORD 1490763

Marca / Brand:	Modello / Model:	Versioni / Version:	Da anno / From :	Ad anno / To:	Marce / Gears:	Codice AB PARTS		Lubrificante Consigliato
FORD	FOCUS III Turnier	1.0 EcoBoost; 1.5 EcoBoost; 1.5 TDCi; 1.6 Ti; 2.0; 2.0 TDCi; 2.0 TDCi ST; 2.0 Ti-GDi	lug-10	feb-20	6	AB6098AT + AB6100AT *	- AB6099AT *	FORD 1490763
FORD	FOCUS IV (HN)	1.0 EcoBoost; 1.0 EcoBoost mHEV; 1.0 EcoBoost mHEV Active; 1.0 EcoBoost mHEV Flex; 1.5 EcoBlue; 1.5 EcoBoost; 1.5 Ti-VCT; 2.0 EcoBlue; 2.0 ST EcoBlue	gen-18	In produzione	8	AB6035AT + AB6036AT	-	FORD WSS-M2C949-A
FORD	FOCUS IV Tre volumi (HM)	1.0 EcoBoost; 1.5 EcoBlue; 1.5 EcoBoost; 1.5 Ti-VCT	nov-18	In produzione	8	AB6035AT + AB6036AT	-	FORD WSS-M2C949-A
FORD	FOCUS IV Turnier (HP)	1.0 EcoBoost; 1.0 EcoBoost mHEV; 1.0 EcoBoost mHEV Flex; 1.5 EcoBlue; 1.5 EcoBoost; 1.5 Ti-VCT; 2.0 EcoBlue; 2.0 ST EcoBlue	set-18	In produzione	8	AB6035AT + AB6036AT	-	FORD WSS-M2C949-A
FORD	GALAXY I (WGR)	1.9 TDI; 2.8 V6	apr-00	mag-06	5	AB6072AT	-	ATF Type K17
FORD	GALAXY II (WA6)	1.6 EcoBoost; 1.6 TDCi; 1.8 TDCi; 2.0; 2.0 EcoBoost; 2.0 Flexifuel; 2.0 TDCi; 2.2 TDCi; 2.3	mag-06	giu-15	6	AB6098AT + AB6100AT *	- AB6099AT *	FORD 1490763
FORD	GALAXY II (WA6)	2.0; 2.0 EcoBoost; 2.0 TDCi; 2.2 TDCi; 2.3	mag-06	giu-15	6	AB6098AT + AB6100AT *	- AB6099AT *	FORD 1490763
FORD	GALAXY III (CK)	1.5 EcoBoost; 2.0 EcoBlue; 2.0 EcoBlue 4x4; 2.0 EcoBlue Bi-Turbo; 2.0 EcoBoost; 2.0 TDCi; 2.0 TDCi 4x4; 2.0 TDCi Bi-Turbo; 2.5 FHEV	gen-15	In produzione	6	AB6098AT + AB6100AT *	- AB6099AT *	FORD 1490763
FORD	GALAXY III (CK)	2.0 EcoBlue; 2.0 EcoBlue 4x4; 2.0 EcoBlue Bi-Turbo; 2.0 EcoBoost; 2.0 TDCi; 2.0 TDCi 4x4; 2.0 TDCi Bi-Turbo	gen-15	In produzione	6	AB6098AT + AB6100AT *	- AB6099AT *	FORD 1490763
FORD	GALAXY MK II VAN (WA6)	2.0 EcoBoost; TDCi	mag-06	giu-15	6	AB6098AT + AB6100AT *	- AB6099AT *	FORD 1490763
FORD	GALAXY MK II VAN (WA6)	2.0; 2.0 EcoBoost; EcoBoost; TDCi	mag-06	giu-15	6	AB6098AT + AB6100AT *	- AB6099AT *	FORD 1490763
FORD	GALAXY MK III VAN (CK)	2.0 EcoBlue; 2.0 EcoBlue AWD	mar-19	In produzione	6	AB6098AT + AB6100AT *	- AB6099AT *	FORD 1490763
FORD	GALAXY MK III VAN (CK)	2.0 EcoBlue; 2.0 EcoBlue AWD	mar-19	In produzione	6	AB6098AT + AB6100AT *	- AB6099AT *	FORD 1490763
FORD	GLADIATOR Pick UP (JT)	3.0D AWD, 3.6 VVT	apr-19	In produzione	8	AB6073AT	-	FIAT 9.55550-AV5
FORD	GRAND C-MAX (DXA/CB7, DXA/CEU)	1.0 EcoBoost; 1.5 EcoBoost; 1.5 TDCi; 1.6 EcoBoost; 1.6 TDCi; 1.6 Ti; 2.0 TDCi	dic-10	giu-19	6	AB6098AT + AB6100AT *	- AB6099AT *	FORD 1490763
FORD	GRAND C-MAX (DXA/CB7, DXA/CEU)	2.0 TDCi	feb-11	giu-19	4	AB6033AT	-	MERCON V
FORD	GRAND C-MAX Van	1.0 EcoBoost; 1.5 EcoBoost; 1.5 TDCi; 1.6 EcoBoost; 1.6 TDCi; 1.6 Ti; 2.0 TDCi	dic-10	giu-19	6	AB6098AT + AB6100AT *	- AB6099AT *	FORD 1490763
FORD	KUGA I	2.0 TDCi 4x4; 2.5 4x4	feb-08	nov-12	6	AB6098AT + AB6100AT *	- AB6099AT *	FORD 1490763
FORD	KUGA I	2.0 TDCi; 2.0 TDCi 4x4; 2.5 4x4	feb-08	nov-12	6	AB6098AT + AB6100AT *	- AB6099AT *	FORD 1490763
FORD	KUGA I VAN	2.5; TDCi 4x4	feb-08	nov-12	6	AB6098AT + AB6100AT *	- AB6099AT *	FORD 1490763
FORD	KUGA I VAN	2.5; TDCi; TDCi 4x4	feb-08	nov-12	6	AB6098AT + AB6100AT *	- AB6099AT *	FORD 1490763

Marca / Brand:	Modello / Model:	Versioni / Version:	Da anno / From:	Ad anno / To:	Marce / Gears:	Codice AB PARTS		Lubrificante Consigliato
FORD	KUGA II (DM2)	1.5 EcoBoost; 1.5 EcoBoost 4x4; 1.5 EcoBoost E85; 1.5 TDCi; 1.6 EcoBoost; 1.6 EcoBoost 4x4; 2.0 EcoBoost 4x4; 2.0 TDCi; 2.0 TDCi 4x4; 2.5	ott-12	dic-19	6	AB6098AT + AB6100AT *	- AB6099AT *	FORD 1490763
FORD	KUGA II (DM2)	1.5 EcoBoost; 1.5 EcoBoost 4x4; 1.5 TDCi; 1.6 EcoBoost 4x4; 2.0 EcoBoost 4x4; 2.0 TDCi; 2.0 TDCi 4x4; 2.5	ott-12	dic-19	6	AB6098AT + AB6100AT *	- AB6099AT *	FORD 1490763
FORD	KUGA II VAN	1.5 EcoBoost 4x4; 2.0 TDCi; 2.0 TDCi 4x4	set-14	dic-19	6	AB6098AT + AB6100AT *	- AB6099AT *	FORD 1490763
FORD	KUGA II VAN	1.5 EcoBoost; 1.5 EcoBoost 4x4; 1.5 TDCi; 2.0 TDCi; 2.0 TDCi 4x4	giu-12	dic-19	6	AB6098AT + AB6100AT *	- AB6099AT *	FORD 1490763
FORD	KUGA III (DFK)	2.0 EcoBlue mHEV	lug-19	In produzione	8	AB6035AT + AB6036AT	-	FORD WSS-M2C949-A
FORD	MONDEO IV (BA7)	1.6 EcoBoost; 1.6 TDCi; 1.6 Ti; 1.8 TDCi; 2.0; 2.0 EcoBoost; 2.0 Flexifuel; 2.0 LPG; 2.0 SCTi; 2.0 TDCi; 2.2 TDCi; 2.3; 2.5	mar-07	gen-15	6	AB6098AT + AB6100AT *	- AB6099AT *	FORD 1490763
FORD	MONDEO IV (BA7)	2.0 EcoBoost; 2.0 SCTi; 2.0 TDCi; 2.2 TDCi; 2.3	mar-07	gen-15	6	AB6098AT + AB6100AT *	- AB6099AT *	FORD 1490763
FORD	MONDEO IV Tre volumi (BA7)	1.6 EcoBoost; 1.6 TDCi; 1.6 Ti; 1.8 TDCi; 2.0; 2.0 EcoBoost; 2.0 Flexifuel; 2.0 LPG; 2.0 SCTi; 2.0 TDCi; 2.2 TDCi; 2.3; 2.5	mar-07	gen-15	6	AB6098AT + AB6100AT *	- AB6099AT *	FORD 1490763
FORD	MONDEO IV Tre volumi (BA7)	2.0 EcoBoost; 2.0 SCTi; 2.0 TDCi; 2.2 TDCi; 2.3	mar-07	gen-15	6	AB6098AT + AB6100AT *	- AB6099AT *	FORD 1490763
FORD	MONDEO IV Turnier (BA7)	1.6 EcoBoost; 1.6 TDCi; 1.6 Ti; 1.8 TDCi; 2.0; 2.0 EcoBoost; 2.0 Flexifuel; 2.0 LPG; 2.0 SCTi; 2.0 TDCi; 2.2 TDCi; 2.3; 2.5	mar-07	gen-15	6	AB6098AT + AB6100AT *	- AB6099AT *	FORD 1490763
FORD	MONDEO IV Turnier (BA7)	2.0 EcoBoost; 2.0 SCTi; 2.0 TDCi; 2.2 TDCi; 2.3	mar-07	gen-15	6	AB6098AT + AB6100AT *	- AB6099AT *	FORD 1490763
FORD	MONDEO IV Van	1.6 EcoBoost; 1.6 TDCi; 2.0; 2.0 EcoBoost; 2.0 TDCi	mar-07	set-14	6	AB6098AT + AB6100AT *	- AB6099AT *	FORD 1490763
FORD	MONDEO IV Van	2.0 EcoBoost; 2.0 TDCi	mar-07	set-14	6	AB6098AT + AB6100AT *	- AB6099AT *	FORD 1490763
FORD	MONDEO V Hatchback (CE)	1.0 EcoBoost; 1.5 EcoBoost; 1.5 TDCi; 1.6 TDCi; 2.0 EcoBlue; 2.0 EcoBlue 4x4; 2.0 EcoBoost; 2.0 TDCi; 2.0 TDCi 4x4; 2.0 TDCi Bi-Turbo	set-14	In produzione	6	AB6098AT + AB6100AT *	- AB6099AT *	FORD 1490763
FORD	MONDEO V Tre volumi (CD)	1.0 EcoBoost; 1.5 EcoBoost; 1.5 TDCi; 2.0 EcoBlue; 2.0 EcoBlue 4x4; 2.0 EcoBoost; 2.0 Hybrid; 2.0 TDCi; 2.0 TDCi 4x4; 2.0 TDCi Bi-Turbo; 2.5	ago-14	In produzione	6	AB6098AT + AB6100AT *	- AB6099AT *	FORD 1490763
FORD	MONDEO V Turnier (CF)	1.0 EcoBoost; 1.5 EcoBoost; 1.5 TDCi; 1.6 TDCi; 2.0 EcoBlue; 2.0 EcoBlue 4x4; 2.0 EcoBoost; 2.0 Hybrid iVCT; 2.0 TDCi; 2.0 TDCi 4x4; 2.0 TDCi Bi-Turbo	set-14	In produzione	6	AB6098AT + AB6100AT *	- AB6099AT *	FORD 1490763
FORD	RANGER (TKE)	2.0 EcoBlue 4x4; 2.2 TDCi; 2.2 TDCi 4x4; 3.2 TDCi 4x4	apr-11	In produzione	10	AB6041AT + AB6042AT	-	DEXRON ULV
FORD	S-MAX (CJ, WA6)	1.5 EcoBoost; 2.0 EcoBlue; 2.0 EcoBlue 4x4; 2.0 EcoBlue Bi-Turbo; 2.0 EcoBoost; 2.0 TDCi; 2.0 TDCi 4x4; 2.0 TDCi Bi-Turbo; 2.5 FHEV	gen-15	In produzione	6	AB6098AT + AB6100AT *	- AB6099AT *	FORD 1490763
FORD	S-MAX (CJ, WA6)	2.0 EcoBlue; 2.0 EcoBlue 4x4; 2.0 EcoBlue Bi-Turbo; 2.0 EcoBoost; 2.0 TDCi; 2.0 TDCi 4x4; 2.0 TDCi Bi-Turbo	gen-15	In produzione	6	AB6098AT + AB6100AT *	- AB6099AT *	FORD 1490763
FORD	S-MAX (WA6)	1.6 EcoBoost; 1.6 TDCi; 1.8 TDCi; 2.0; 2.0 EcoBoost; 2.0 Flexifuel; 2.0 TDCi; 2.2 TDCi; 2.3; 2.5 ST	mag-06	dic-14	6	AB6098AT + AB6100AT *	- AB6099AT *	FORD 1490763

Marca / Brand:	Modello / Model:	Versioni / Version:	Da anno / From:	Ad anno / To:	Marce / Gears:	Codice AB PARTS		Lubrificante Consigliato
FORD	S-MAX (WA6)	2.0 EcoBoost; 2.0 Flexifuel; 2.0 TDCi; 2.2 TDCi; 2.3	mag-06	dic-14	6	AB6098AT + AB6100AT *	- AB6099AT *	FORD 1490763
FORD	S-MAX VAN (WA6)	1.6; 2.0; 2.0 EcoBoost; 2.0 TDCi	gen-07	dic-14	6	AB6098AT + AB6100AT *	- AB6099AT *	FORD 1490763
FORD	S-MAX VAN (WA6)	2.0 EcoBoost; 2.0 TDCi	mar-10	dic-14	6	AB6098AT + AB6100AT *	- AB6099AT *	FORD 1490763
FORD	TOURNEO CONNECT / GRAND TOURNEO CONNECT V408 MPV / Space wag	1.0 EcoBoost; 1.5 EcoBlue; 1.5 TDCi; 1.6 EcoBoost; 1.6 TDCi	set-13	dic-22	6	AB6098AT + AB6100AT *	- AB6099AT *	FORD 1490763
FORD	TOURNEO CONNECT / GRAND TOURNEO CONNECT V408 MPV / Space wag	1.5 EcoBlue; 1.5 TDCi; 1.6 EcoBoost	nov-13	dic-22	6	AB6098AT + AB6100AT *	- AB6099AT *	FORD 1490763
FORD	TOURNEO COURIER B460 MPV / Space wagon	1.0 EcoBoost; 1.5 TDCi; 1.6 TDCi	feb-14	dic-23	6	AB6098AT + AB6100AT *	- AB6099AT *	FORD 1490763
FORD	TRANSIT CONNECT MPV / Space wagon	1.5 EcoBlue; 1.5 TDCi	mag-15	In produzione	6	AB6098AT + AB6100AT *	- AB6099AT *	FORD 1490763
FORD	TRANSIT CONNECT MPV / Space wagon	1.5 EcoBlue; 1.5 TDCi; 1.6 TDCi	feb-13	In produzione	6	AB6098AT + AB6100AT *	- AB6099AT *	FORD 1490763
FORD	TRANSIT CONNECT V408 Cassone/Limousine spaziosa	1.0 EcoBoost; 1.0 Flexifuel; 1.5 EcoBlue; 1.5 TDCi; 1.6 EcoBoost; 1.6 TDCi	feb-13	In produzione	6	AB6098AT + AB6100AT *	- AB6099AT *	FORD 1490763
FORD	TRANSIT CONNECT V408 Cassone/Limousine spaziosa	1.5 EcoBlue; 1.5 TDCi; 1.6 EcoBoost	nov-13	In produzione	6	AB6098AT + AB6100AT *	- AB6099AT *	FORD 1490763
FORD	TRANSIT CUSTOM V362 Autobus (F3)	2.0 EcoBlue; 2.0 EcoBlue mHEV	dic-15	dic-23	10	AB6041AT + AB6042AT	-	DEXRON ULV
FORD	TRANSIT CUSTOM V362 Furgone (FY, FZ)	2.0 EcoBlue; 2.0 EcoBlue mHEV	dic-15	dic-23	10	AB6041AT + AB6042AT	-	DEXRON ULV
FORD	TRANSIT V363 Autobus (FAD, FBD)	2.0 EcoBlue; 2.0 EcoBlue mHEV; 2.0 EcoBlue RWD	mar-16	In produzione	10	AB6041AT + AB6042AT	-	DEXRON ULV
FORD	TRANSIT V363 Furgone (FCD, FDD)	2.0 EcoBlue; 2.0 EcoBlue 4x4; 2.0 EcoBlue mHEV; 2.0 EcoBlue mHEV RWD; 2.0 EcoBlue RWD	mar-16	In produzione	10	AB6041AT + AB6042AT	-	DEXRON ULV
FORD	TRANSIT V363 Pianale piatto/Telaio (FED, FFD)	2.0 EcoBlue; 2.0 EcoBlue 4x4; 2.0 EcoBlue mHEV; 2.0 EcoBlue mHEV RWD; 2.0 EcoBlue RWD	mar-16	In produzione	10	AB6041AT + AB6042AT	-	DEXRON ULV
FORD	WRANGLER IV (JL)	2.0 4xe, 2.0 T-GDI, 2.2 Multijet	nov-17	In produzione	8	AB6073AT	-	FIAT 9.55550-AV5
HONDA	CIVIC IX (FK)	1.6 i-DTEC; 2.0 i-VTEC Type R	feb-13	dic-16	9	AB6176AT	-	ZF LifeguardFluid 9
HONDA	CIVIC IX Tourer (FK)	1.6 i-DTEC; 1.8 i-VTEC	gen-14	dic-16	9	AB6176AT	-	ZF LifeguardFluid 9
HONDA	CR-V IV (RM_)	1.6 i-DTEC; 1.6 i-DTEC 4WD; 2.4 AWD	ott-13	In produzione	9	AB6176AT	-	ZF LifeguardFluid 9
HUMMER	HUMMER H3	3.5; 3.7 4WD; 5.3 V8 AWD	apr-05	In produzione	4	AB6045AT	-	DEXRON VI
HYUNDAI	ACCENT IV (RB)	1.6; 1.6 CVVT	nov-10	mar-18	6	AB6057AT	-	HYUNDAI SP4-M ATF
HYUNDAI	ACCENT IV Tre volumi (RB)	1.6	nov-10	In produzione	6	AB6057AT	-	HYUNDAI SP4-M ATF
HYUNDAI	ACCENT V Tre volumi (HC)	1.4	lug-18	In produzione	6	AB6055AT	-	HYUNDAI ATF SP IV
HYUNDAI	CRETA	1.6; 1.6 4WD	gen-16	gen-21	6	AB6057AT	-	HYUNDAI SP4-M ATF
HYUNDAI	CRETA	2.0	gen-16	gen-21	6	AB6055AT	-	HYUNDAI ATF SP IV

Marca / Brand:	Modello / Model:	Versioni / Version:	Da anno / From:	Ad anno / To:	Marce / Gears:	Codice AB PARTS		Lubrificante Consigliato
HYUNDAI	ELANTRA IV Tre volumi (HD)	1.6 CVVT	giu-06	giu-11	6	AB6057AT	-	HYUNDAI SP4-M ATF
HYUNDAI	ELANTRA V Tre volumi (MD, UD)	1.6; 1.6 CRDi; 1.8	set-10	dic-16	6	AB6057AT	-	HYUNDAI SP4-M ATF
HYUNDAI	ELANTRA VI Tre volumi (AD, ADA)	1.6; 2.0	ott-15	dic-20	6	AB6055AT	-	HYUNDAI ATF SP IV
HYUNDAI	GRAND SANTA FÉ	2.2 CRDi AWD; 3.3; 3.3 AWD	giu-13	nov-18	6	AB6056AT	-	HYUNDAI ATF SP IV
HYUNDAI	GRANDEUR (HG)	2.4; 2.4 16V; 3.0 MPI	gen-11	In produzione	6	AB6057AT	-	HYUNDAI SP4-M ATF
HYUNDAI	GRANDEUR (HG)	2.4; 2.4 16V; 3.0; 3.0 MPI	gen-11	In produzione	6	AB6056AT	-	HYUNDAI ATF SP IV
HYUNDAI	i30 (FD)	1.6	ott-07	nov-11	6	AB6057AT	-	HYUNDAI SP4-M ATF
HYUNDAI	i30 (GD)	1.6; 1.6 CRDi; 1.6 GDI	dic-11	In produzione	6	AB6057AT	-	HYUNDAI SP4-M ATF
HYUNDAI	i30 Coupé	1.6 CRDi; 1.6 GDI; 1.6 MPI	mag-13	In produzione	6	AB6057AT	-	HYUNDAI SP4-M ATF
HYUNDAI	i30 Familiare (GD)	1.6; 1.6 CRDi; 1.6 GDI	giu-12	In produzione	6	AB6057AT	-	HYUNDAI SP4-M ATF
HYUNDAI	i40 I (VF)	1.7 CRDi; 2.0 CVVT; 2.0 GDI	mar-12	mag-19	6	AB6057AT	-	HYUNDAI SP4-M ATF
HYUNDAI	i40 I CW (VF)	1.7 CRDi; 2.0 CVVT; 2.0 GDI	lug-11	mag-19	6	AB6057AT	-	HYUNDAI SP4-M ATF
HYUNDAI	ix20 (JC)	1.6	nov-10	lug-19	6	AB6057AT	-	HYUNDAI SP4-M ATF
HYUNDAI	ix35 (LM, EL, ELH)	1.6; 2.0; 2.0 4WD; 2.0 CVVT; 2.0 CVVT 4WD; 2.0 CVVT AWD; 2.0 GDI; 2.0 GDi 4WD	ago-09	dic-15	6	AB6057AT	-	HYUNDAI SP4-M ATF
HYUNDAI	ix35 (LM, EL, ELH)	2.0 CRDi; 2.0 CRDi 4WD	gen-10	dic-15	6	AB6056AT	-	HYUNDAI ATF SP IV
HYUNDAI	ix35 Van	CRDi 4WD	ago-09	dic-15	6	AB6056AT	-	HYUNDAI ATF SP IV
HYUNDAI	ix55	3.0 V6 CRDi 4WD	set-08	dic-12	6	AB6056AT	-	HYUNDAI ATF SP IV
HYUNDAI	SANTA FÉ II (CM)	2.4; 2.4 4x4	lug-10	dic-12	6	AB6057AT	-	HYUNDAI SP4-M ATF
HYUNDAI	SANTA FÉ III (DM, DMA)	2.2 CRDi; 2.2 CRDi 4WD	set-12	ago-18	6	AB6056AT	-	HYUNDAI ATF SP IV
HYUNDAI	SANTA FÉ III (DM, DMA)	2.4; 2.4 4WD; 2.4 CCVT; 2.4 CCVT AWD; 2.4 GDI 4WD	set-12	dic-18	6	AB6057AT	-	HYUNDAI SP4-M ATF
HYUNDAI	SANTA FÉ III Cassone/SUV (DM)	CRDi 4x4	mag-15	In produzione	6	AB6056AT	-	HYUNDAI ATF SP IV
HYUNDAI	SANTA FE IV (TM, TMA)	2.4 AWD	lug-18	lug-20	6	AB6057AT	-	HYUNDAI SP4-M ATF
HYUNDAI	SANTA FE IV (TM, TMA)	2.4 GDI AWD	lug-18	lug-20	6	AB6055AT	-	HYUNDAI ATF SP IV
HYUNDAI	SOLARIS Tre volumi (HCR, HCI)	1.6	gen-17	In produzione	6	AB6055AT	-	HYUNDAI ATF SP IV
HYUNDAI	SONATA VI (YF)	2.0; 2.0 Hybrid; 2.0 i; 2.4	giu-09	dic-15	6	AB6057AT	-	HYUNDAI SP4-M ATF
HYUNDAI	SONATA VII (LF)	2.4	set-14	dic-19	6	AB6057AT	-	HYUNDAI SP4-M ATF
HYUNDAI	TUCSON (07/18>06/21)	2.0CRDi 48V	lug-18	gen-20	8	AB6058AT	-	HYUNDAI ATF SP IV
HYUNDAI	TUCSON (TL, TLE)	1.6 GDi; 1.6 T-GDi; 1.6 T-GDi AWD; 2.0; 2.0 CVVT; 2.0 CVVT AWD; 2.0 AWD	giu-15	set-20	6	AB6057AT	-	HYUNDAI SP4-M ATF
HYUNDAI	TUCSON (TL, TLE)	2.0 CRDi; 2.0 CRDi Hybrid 48V AWD; 2.0 CRDi AWD	giu-15	dic-20	6	AB6056AT	-	HYUNDAI ATF SP IV
HYUNDAI	TUCSON (TL, TLE)	2.4 GDI AWD	lug-19	set-20	6	AB6055AT	-	HYUNDAI ATF SP IV
HYUNDAI	TUCSON Cassone/SUV (TLE)	1.6 T-GDi	giu-15	dic-20	6	AB6057AT	-	HYUNDAI SP4-M ATF
HYUNDAI	VELOSTER (FS)	1.6 GDI; 1.6 MPI; 1.6 T-GDI	mar-11	dic-17	6	AB6057AT	-	HYUNDAI SP4-M ATF
INFINITI	Q30	1.5 D; 1.6; 2.0 T; 2.0 T AWD; 2.2 D; 2.2 D AWD	nov-15	In produzione	7	AB6080AT + AB6081AT	-	MB 236.21
INFINITI	Q50	2.0 T; 50 D	apr-13	In produzione	7	AB6083AT	-	MB 236.21
INFINITI	Q50	2.0 T; 50 D; 50 Hybrid; 50 Hybrid AWD; 50 Red; 50 Red AWD	apr-13	In produzione	7	AB6082AT	-	MB 236.21
INFINITI	Q60 Coupé	2.0 T	set-16	In produzione	7	AB6083AT	-	MB 236.21
INFINITI	Q70 (Y51)	2.2 D; 3.7	mar-13	In produzione	7	AB6083AT	-	MB 236.21

Marca / Brand:	Modello / Model:	Versioni / Version:	Da anno / From:	Ad anno / To:	Marce / Gears:	Codice AB PARTS		Lubrificante Consigliato
INFINITI	QX30	2.2 D AWD	apr-16	In produzione	7	AB6080AT + AB6081AT	-	MB 236.21
IVECO	DAILY VI Furgone	35S18, 35C18, 40C18, 50C18, 60C18, 65C18, 70C18; 55C18, 55S18, 70S18, 70C18	apr-16	In produzione	8	AB6164AT	-	ZF Lifeguard Fluid 8
IVECO	DAILY VI Pianale piatto/Telaio	35S18, 35C18, 40C18, 50C18, 60C18, 65C18, 70C18; 35S18, 55S18, 55C18, 70S18, 70C18 4x4	apr-16	In produzione	8	AB6164AT	-	ZF Lifeguard Fluid 8
JAGUAR	F-PACE (X761)	2.0 D165 MHEV; 2.0 D200 MHEV; 2.0 P400e Plug-in Hybrid; 2.0 SD4 AWD; 2.0 TD4; 2.0 TD4 AWD; 2.0 Ti4; 2.0 Ti4 AWD; 3.0 D300 MHEV; 3.0 P400 MHEV; 3.0 SCV6 AWD; 3.0 SDV6 AWD; 5.0 SCV8 SVR AWD; 5.0 SVR P550 MHEV; 5.0 SVR P575	set-15	In produzione	8	AB6164AT	-	ZF Lifeguard Fluid 8
JAGUAR	F-TYPE Cabriolet (X152)	2.0 Ti4; 3.0 SCV6; 3.0 SCV6 S; 3.0 SCV6 S AWD; 5.0 SCV8 P450; 5.0 SCV8 P450 AWD; 5.0 SCV8 R; 5.0 SCV8 R AWD; 5.0 SCV8 S; 5.0 SCV8 SVR; SCV6 400 SPORT; SCV6 400 SPORT AWD; 5.0 SCV8 SVR AWD	ott-12	In produzione	8	AB6164AT	-	ZF Lifeguard Fluid 8
JAGUAR	F-TYPE Coupé (X152)	2.0 Ti4; 3.0 SCV6; 3.0 SCV6 400 SPORT; 3.0 SCV6 400 SPORT AWD; 3.0 SCV6 S; 3.0 SCV6 S AWD; 5.0 SCV8 P450; 5.0 SCV8 P450 AWD; 5.0 SCV8 R; 5.0 SCV8 R AWD; 5.0 SCV8 SVR	ott-13	In produzione	8	AB6164AT	-	ZF Lifeguard Fluid 8
JAGUAR	S-TYPE II (X200)	2.5 V6; 2.7 D; 3.0 V6; 4.0 V8; 4.2 V8; R 4.2 V8	gen-99	ott-07	6	AB6163AT	-	ZF Lifeguard Fluid 6
JAGUAR	XE (X760)	2.0; 2.0 AWD; 2.0 D; 2.0 D AWD; 2.0 D200 MHEV; 2.0 D200 MHEV AWD; 3.0 S; 5.0 SVO PROJECT 8; P250	mar-15	In produzione	8	AB6164AT	-	ZF Lifeguard Fluid 8
JAGUAR	XF I (X250)	2.0; 2.2 D; 2.7 D; 3.0; 3.0 AWD; 3.0 D; 4.2; 4.2 Kompressor; 5.0; 5.0 Kompressor; 5.0 XFR-S	mar-08	apr-15	8	AB6164AT	-	ZF Lifeguard Fluid 8
JAGUAR	XF I (X250)	2.0; 2.2 D; 2.7 D; 3.0; 3.0 AWD; 3.0 D; 4.2; 4.2 Kompressor; 5.0; 5.0 Kompressor; 5.0 XFR-S	mar-08	apr-15	6	AB6163AT	-	ZF Lifeguard Fluid 6
JAGUAR	XF II (X260)	2.0; 2.0 AWD; 2.0 D; 2.0 D AWD; 2.0 D200 MHEV; 2.0 D200 MHEV AWD; 3.0; 3.0 AWD; 3.0 D	mag-15	In produzione	8	AB6164AT	-	ZF Lifeguard Fluid 8
JAGUAR	XF SPORTBRAKE (X250)	2.2 D; 3.0 D; 5.0 XFR-S	set-12	apr-14	8	AB6164AT	-	ZF Lifeguard Fluid 8
JAGUAR	XF SPORTBRAKE (X250)	2.2 D; 3.0 D; 5.0 XFR-S	set-12	apr-14	6	AB6163AT	-	ZF Lifeguard Fluid 6
JAGUAR	XF SPORTBRAKE (X260)	2.0; 2.0 AWD; 2.0 D; 2.0 D AWD; 2.0 D200 MHEV; 2.0 D200 MHEV AWD; 3.0; 3.0 AWD; 3.0 D	lug-17	In produzione	8	AB6164AT	-	ZF Lifeguard Fluid 8
JAGUAR	XJ (X350, X358)	3.0; 3.6; 4.2; D 2.7; R 4.2	mar-03	mar-09	6	AB6163AT	-	ZF Lifeguard Fluid 6
JAGUAR	XJ (X351)	2.0 Ti4; 3.0 SCV6; 3.0 SCV6 AWD; 3.0 SDV6; 5.0 SCV8; 5.0 SCV8 R575; 5.0 V8	ott-09	In produzione	8	AB6164AT	-	ZF Lifeguard Fluid 8
JAGUAR	XJ (X351)	2.0 Ti4; 3.0 SCV6; 3.0 SCV6 AWD; 3.0 SDV6; 5.0 SCV8; 5.0 SCV8 R575; 5.0 V8	ott-09	In produzione	6	AB6163AT	-	ZF Lifeguard Fluid 6
JAGUAR	XK 8 Convertible (X100)	4.0; 4.0 XKR; 4.2; R 4.2	mar-96	dic-06	5	AB6151AT	-	ESSO LT 71141
JAGUAR	XK 8 Convertible (X100)	4.0; 4.2; R 4.2	mar-96	dic-06	6	AB6163AT	-	ZF Lifeguard Fluid 6
JAGUAR	XK 8 Coupé (X100)	4.0; 4.0 XKR; 4.2; R 4.2	mar-96	lug-05	5	AB6151AT	-	ESSO LT 71141
JAGUAR	XK 8 Coupé (X100)	4.0; 4.2; R 4.2	mar-96	lug-05	6	AB6163AT	-	ZF Lifeguard Fluid 6
JAGUAR	XK II Cabriolet (X150)	4.2 XK8; 4.2 XKR; 5.0 V8; 5.0 XKR; 5.0 XKR-S	mar-06	lug-14	6	AB6163AT	-	ZF Lifeguard Fluid 6
JAGUAR	XK II Coupé (X150)	3.6; 4.2 XK8; 4.2 XKR; 5.0 V8; 5.0 XKR; 5.0 XKR-S	mar-06	lug-14	6	AB6163AT	-	ZF Lifeguard Fluid 6
JAGUAR	XK II Coupé (X150)	4.2 XK8; 4.2 XKR	mar-06	lug-14	5	AB6151AT	-	ESSO LT 71141
JEEP	CHEROKEE (KJ)	2.4 Laredo; 3.7 Laredo	ott-01	set-04	4 / 5 / 6	AB6020AT	-	MOPAR ATF +4
JEEP	CHEROKEE (KJ)	2.8 CRD 4x4; 3.7 4x4	set-01	gen-08	4	AB6019AT	-	MOPAR ATF +4
JEEP	CHEROKEE (KJ)	2.8 CRD 4x4; 3.7 4x4; 3.7 Laredo	set-01	gen-08	4 / 5 / 6	AB6021AT	-	MOPAR ATF +4
JEEP	CHEROKEE (KJ)	3.7 4x4	set-01	ott-07	5	AB6078AT	-	MB 236.14
JEEP	CHEROKEE (KK)	2.8 CRD 4x4; 3.7 V6; 3.7 V6 4x4; 3.7 V6 AWD	gen-08	In produzione	5	AB6078AT	-	MB 236.14
JEEP	CHEROKEE (KL)	2.0 CRD; 2.0 CRD 4x4; 2.0 T-GDi; 2.2 CRD; 2.2 CRD 4x4; 2.4; 2.4 4x4; 3.2 4x4; 3.2 V6; 3.2 V6 4x4	nov-13	In produzione	9	AB6176AT	-	ZF LifeguardFluid 9

Marca / Brand:	Modello / Model:	Versioni / Version:	Da anno / From:	Ad anno / To:	Marce / Gears:	Codice AB PARTS		Lubrificante Consigliato
JEEP	CHEROKEE (SJ)	2.5; 5.9 4x4	ott-80	set-86	4	AB6120AT	-	Toyota ATF Type T-IV
JEEP	CHEROKEE (XJ)	2.1 TD; 2.5 Tdi 4x4; 4.0 i; 4.0 i 4x4	ott-84	set-01	4	AB6120AT	-	Toyota ATF Type T-IV
JEEP	CHEROKEE VAN (KL)	2.0 CRD; 2.2 CRD; 3.2 4x4	apr-14	In produzione	9	AB6176AT	-	ZF LifeguardFluid 9
JEEP	COMMANDER (XK, XH)	3.0 CRD 4x4; 3.7 V6 4x4; 4.7 V8 4x4; 5.7 V8 4x4	set-05	dic-10	5	AB6078AT	-	MB 236.14
JEEP	COMMANDER (XK, XH)	4.7 V8 4x4; 5.7 V8 4x4	set-05	dic-10	4 / 5 / 6	AB6021AT	-	MOPAR ATF +4
JEEP	COMMANDER VAN (XH)	3.0 CRD 4x4; 5.7 HEMI V8 4x4	set-05	dic-10	5	AB6078AT	-	MB 236.14
JEEP	COMMANDER VAN (XH)	5.7 HEMI V8 4x4	set-05	dic-10	4 / 5 / 6	AB6021AT	-	MOPAR ATF +4
JEEP	GRAND CHEROKEE I (ZJ, ZG)	4.0 i 4x4; 4.0 Laredo; 5.2; 5.2 4x4; 5.2 i 4x4; 5.2 Limited 4x4; 5.9 i 4x4	set-91	apr-99	4	AB6018AT	-	MOPAR ATF +4
JEEP	GRAND CHEROKEE I (ZJ, ZG)	4.0 i 4x4; 5.2; 5.2 4x4; 5.2 i 4x4; 5.2 Limited 4x4	set-91	apr-99	6 / 8	AB6023AT	-	MOPAR ATF +4
JEEP	GRAND CHEROKEE II (WJ, WG)	2.7 CRD 4x4; 3.1 TD 4x4; 4.0 4x4; 4.7 V8 4x4	apr-99	set-05	4	AB6018AT	-	MOPAR ATF +4
JEEP	GRAND CHEROKEE II (WJ, WG)	2.7 CRD 4x4; 4.0 4x4; 4.7 V8 4x4	apr-99	set-05	5	AB6078AT	-	MB 236.14
JEEP	GRAND CHEROKEE II (WJ, WG)	4.7 V8 4x4	apr-99	set-05	4 / 5 / 6	AB6021AT	-	MOPAR ATF +4
JEEP	GRAND CHEROKEE III (WH, WK)	3.0 CRD; 3.0 CRD 4x4; 3.7 V6; 3.7 V6 4x4; 4.7 V8; 4.7 V8 4x4; 4.7 V8 FLEX; 5.7; 5.7 V8 4x4; 6.1 SRT8 4x4; 6.1 SRT8 RWD	ott-04	dic-10	5	AB6078AT	-	MB 236.14
JEEP	GRAND CHEROKEE III (WH, WK)	4.7 4x4; 4.7 V8; 4.7 V8 4x4; 5.7; 5.7 V8 4x4	ott-04	dic-10	4 / 5 / 6	AB6021AT	-	MOPAR ATF +4
JEEP	GRAND CHEROKEE IV (WK, WK2)	3.0 CRD; 3.0 CRD V6 4x4; 3.0 V6 4x4; 3.6 V6; 3.6 V6 4x4; 3.6 V6 FlexFuel 4x4; 3.6 VVT 4x4; 5.7 4x4; 5.7 V8 4x4; 6.4 SRT8 4x4	nov-10	In produzione	8	AB6164AT	-	ZF Lifeguard Fluid 8
JEEP	GRAND CHEROKEE IV (WK, WK2)	3.0 CRD; 3.0 CRD V6 4x4; 3.0 V6 4x4; 3.6 V6; 3.6 V6 4x4; 3.6 V6 FlexFuel 4x4; 3.6 VVT 4x4; 5.7 4x4; 5.7 V8 4x4; 6.4 SRT8 4x4	nov-10	In produzione	5	AB6078AT	-	MB 236.14
JEEP	GRAND CHEROKEE IV (WK, WK2)	3.0 CRD; 3.0 CRD V6 4x4; 3.0 V6 4x4; 3.6 VVT 4x4; 6.2 i V8 4x4	lug-13	In produzione	9	AB6176AT	-	ZF LifeguardFluid 9
JEEP	GRAND CHEROKEE IV (WK, WK2)	3.0 CRD; 3.0 CRD V6 4x4; 6.4 SRT8 4x4	feb-11	In produzione	8	AB6170AT	-	ZF Lifeguard Fluid 8
JEEP	GRAND CHEROKEE IV (WK, WK2)	5.7 4x4; 5.7 V8 4x4	nov-10	In produzione	4 / 5 / 6	AB6021AT	-	MOPAR ATF +4
JEEP	GRAND CHEROKEE L V (WL)	2.0 4xe Plug-in Hybrid	mag-21	In produzione	9	AB6176AT	-	ZF LifeguardFluid 9
JEEP	GRAND CHEROKEE VAN (WK2)	3.0 CRD; 5.7 HEMI 4x4; V6 VVT	lug-13	In produzione	8	AB6164AT	-	ZF Lifeguard Fluid 8
JEEP	GRAND CHEROKEE VAN (WK2)	3.0 CRD; 5.7 HEMI 4x4; V6 VVT	lug-13	In produzione	5	AB6078AT	-	MB 236.14
JEEP	GRAND CHEROKEE VAN (WK2)	3.0 CRD; 5.7 HEMI 4x4; V6 VVT	lug-13	In produzione	9	AB6176AT	-	ZF LifeguardFluid 9
JEEP	GRAND CHEROKEE VAN (WK2)	5.7 HEMI 4x4	lug-13	In produzione	4 / 5 / 6	AB6021AT	-	MOPAR ATF +4
JEEP	WRANGLER I (YJ, SJ_)	4.0; 4.0 2WD; 4.0 4x4	ott-86	ago-96	6 / 8	AB6023AT	-	MOPAR ATF +4
JEEP	WRANGLER II (TJ)	2.4	nov-02	apr-07	5	AB6078AT	-	MB 236.14
JEEP	WRANGLER II (TJ)	2.4; 4.0; 4.0 Rubicon	ago-96	apr-07	4	AB6019AT	-	MOPAR ATF +4
JEEP	WRANGLER II (TJ)	4.0; 4.0 Rubicon	ago-96	apr-07	6 / 8	AB6023AT	-	MOPAR ATF +4
JEEP	WRANGLER III (JK)	2.8 CRD	apr-07	In produzione	4 / 5 / 6	AB6021AT	-	MOPAR ATF +4
JEEP	WRANGLER III (JK)	2.8 CRD; 3.6 V6	apr-07	In produzione	5	AB6078AT	-	MB 236.14
JEEP	WRANGLER III (JK)	2.8 CRD; 3.8 RWD	apr-07	In produzione	4 / 5 / 6	AB6020AT	-	MOPAR ATF +4
JEEP	WRANGLER III (JK)	2.8 CRD; 3.8; 3.8 RWD	apr-07	In produzione	4	AB6019AT	-	MOPAR ATF +4
KIA	CADENZA I (VG)	3.5 CVT	gen-10	dic-15	6	AB6056AT	-	HYUNDAI ATF SP IV
KIA	CADENZA II (YG)	3.3 GDI; 3.3 MPI	gen-16	In produzione	6	AB6056AT	-	HYUNDAI ATF SP IV
KIA	CARENS IV	1.7 CRDi; 2.0 GDi; 2.0 MPI	mar-13	In produzione	6	AB6057AT	-	HYUNDAI SP4-M ATF
KIA	CARENS IV Van (A4)	CRDi	apr-15	ago-16	6	AB6057AT	-	HYUNDAI SP4-M ATF
KIA	CARNIVAL / GRAND CARNIVAL III (VQ)	2.2 CRDi	gen-10	giu-15	6	AB6056AT	-	HYUNDAI ATF SP IV
KIA	CEED (CD)	1.6	mar-18	In produzione	6	AB6055AT	-	HYUNDAI ATF SP IV
KIA	CEE'D (JD)	1.6 CVT; 1.6 GDI	mag-12	lug-18	6	AB6057AT	-	HYUNDAI SP4-M ATF

Marca / Brand:	Modello / Model:	Versioni / Version:	Da anno / From:	Ad anno / To:	Marce / Gears:	Codice AB PARTS		Lubrificante Consigliato
KIA	CEED Sportswagon (CD)	1.6	mag-18	In produzione	6	AB6055AT	-	HYUNDAI ATF SP IV
KIA	CEE'D Sportswagon (JD)	1.6 CVVT; 1.6 GDI	set-12	lug-18	6	AB6057AT	-	HYUNDAI SP4-M ATF
KIA	CERATO II Tre volumi (TD)	1.6; 1.6 CVVT; 2.0; 2.0 CVVT	gen-09	feb-14	6	AB6057AT	-	HYUNDAI SP4-M ATF
KIA	CERATO III Tre volumi (YD)	2.0 MPI	giu-13	giu-18	6	AB6057AT	-	HYUNDAI SP4-M ATF
KIA	CERATO KOUP II (TD)	1.6 CVVT; 2.0 CVVT	gen-09	giu-13	6	AB6057AT	-	HYUNDAI SP4-M ATF
KIA	OPTIMA (FSGDS6B)	1.7 CRDi; 2.0; 2.0 CVVL; 2.0 CVVT; 2.4; 2.4 CVVT	set-10	dic-15	6	AB6057AT	-	HYUNDAI SP4-M ATF
KIA	OPTIMA (FSGDS6B)	2.0; 2.0 CVVL; 2.0 CVVT	set-10	dic-15	6	AB6056AT	-	HYUNDAI ATF SP IV
KIA	OPTIMA (JF)	2.0; 2.0 CVVL	set-15	dic-19	6	AB6055AT	-	HYUNDAI ATF SP IV
KIA	OPTIMA (JF)	2.0; 2.0 CVVL; 2.0 GDI Hybrid; 2.0 T-GDi	set-15	dic-19	6	AB6056AT	-	HYUNDAI ATF SP IV
KIA	OPTIMA (JF)	2.0; 2.0 CVVL; 2.0 T-GDi; 2.4 GDI; 2.4 MPI	set-15	dic-19	6	AB6057AT	-	HYUNDAI SP4-M ATF
KIA	OPTIMA Sportswagon (JF)	2.0 CVVL	set-16	dic-19	6	AB6055AT	-	HYUNDAI ATF SP IV
KIA	OPTIMA Sportswagon (JF)	2.0 CVVL; 2.0 GDI Hybrid; 2.0 T-GDi; 2.0 T-GDi GT	set-16	dic-19	6	AB6056AT	-	HYUNDAI ATF SP IV
KIA	OPTIMA Sportswagon (JF)	2.0 CVVL; 2.0 T-GDi	set-16	dic-19	6	AB6057AT	-	HYUNDAI SP4-M ATF
KIA	PRO CEE'D (JD)	1.6 CVVT; 1.6 GDI	mar-13	lug-18	6	AB6057AT	-	HYUNDAI SP4-M ATF
KIA	RIO III (UB)	1.6 CVVT	giu-12	dic-17	6	AB6057AT	-	HYUNDAI SP4-M ATF
KIA	RIO III Tre volumi (UB)	1.6 CVVT	giu-12	dic-17	6	AB6057AT	-	HYUNDAI SP4-M ATF
KIA	RIO IV (YB, SC, FB)	1.4	gen-17	In produzione	6	AB6055AT	-	HYUNDAI ATF SP IV
KIA	RIO IV Tre volumi (SC, FB)	1.6	lug-17	In produzione	6	AB6055AT	-	HYUNDAI ATF SP IV
KIA	SELTOS (SP2, SP2I)	1.6 MPI	set-19	In produzione	6	AB6055AT	-	HYUNDAI ATF SP IV
KIA	SORENTO 3ª SERIE	2.0CRDI	nov-17	gen-21	8	AB6058AT	-	HYUNDAI ATF SP IV
KIA	SORENTO II (XM)	2.2 CRDi; 2.2 CRDi 4WD; 3.5; 3.5 4WD	nov-09	dic-15	6	AB6056AT	-	HYUNDAI ATF SP IV
KIA	SORENTO II (XM)	2.4 CVVT; 2.4 CVVT 4WD; 2.4 GDI; 2.4 GDI 4WD	nov-09	dic-15	6	AB6057AT	-	HYUNDAI SP4-M ATF
KIA	SORENTO II Cassone/SUV (XM)	CRDi 4WD	nov-09	dic-15	6	AB6056AT	-	HYUNDAI ATF SP IV
KIA	SORENTO II Cassone/SUV (XM)	CVVT; CVVT 4WD	giu-09	dic-15	6	AB6057AT	-	HYUNDAI SP4-M ATF
KIA	SORENTO III (UM)	2.0 CRDi 4WD; 2.2 CRDi; 2.2 CRDi 4WD; 3.3; 3.3 4WD; 3.3 CVVT 4WD	gen-15	dic-20	6	AB6056AT	-	HYUNDAI ATF SP IV
KIA	SORENTO III (UM)	2.4 GDI	gen-15	ott-18	6	AB6055AT	-	HYUNDAI ATF SP IV
KIA	SORENTO III (UM)	2.4; 2.4 4WD; 2.4 GDI; 2.4 GDI 4WD	gen-15	dic-20	6	AB6057AT	-	HYUNDAI SP4-M ATF
KIA	SORENTO IV (MQ4, MQ4A)	2.5 MPI AWD	apr-21	In produzione	6	AB6055AT	-	HYUNDAI ATF SP IV
KIA	SOUL I (AM)	1.6 CVVT; 1.6 GDI; 1.6 LPG	feb-09	dic-14	6	AB6057AT	-	HYUNDAI SP4-M ATF
KIA	SOUL II (PS)	1.6 CVVT; 1.6 GDI	feb-14	dic-18	6	AB6057AT	-	HYUNDAI SP4-M ATF
KIA	SOUL III (SK3)	1.6 MPI; 2.0 MPI	gen-19	In produzione	6	AB6055AT	-	HYUNDAI ATF SP IV
KIA	SPORTAGE III (SL)	2.0 CRDi AWD	lug-10	dic-16	6	AB6056AT	-	HYUNDAI ATF SP IV
KIA	SPORTAGE III (SL)	2.0 CVVT; 2.0 CVVT AWD; 2.0 GDI; 2.0 GDI AWD	giu-10	dic-15	6	AB6057AT	-	HYUNDAI SP4-M ATF
KIA	SPORTAGE IV (QL, QLE)	1.6 GDI; 2.4 GDI; 2.4 GDI AWD	set-15	set-22	6	AB6055AT	-	HYUNDAI ATF SP IV
KIA	SPORTAGE IV (QL, QLE)	2.0 CRDi; 2.0 CRDi AWD; 2.0 CRDi Eco-Dynamics+ AWD	set-15	set-22	6	AB6056AT	-	HYUNDAI ATF SP IV
KIA	SPORTAGE IV (QL, QLE)	2.0; 2.0 AWD	dic-15	set-22	6	AB6057AT	-	HYUNDAI SP4-M ATF
KIA	VENGA (YN)	1.6 CVVT	feb-10	mar-19	6	AB6057AT	-	HYUNDAI SP4-M ATF
LAMBORGHINI	URUS	4.0 AWD	feb-18	In produzione	8	AB6174AT	-	ZF Lifeguard Fluid 8
LANCIA	FLAVIA Cabriolet (JS_)	2.4	mar-12	dic-14	6	AB6022AT	-	MOPAR ATF +4
LANCIA	THEMA (LX_)	3.0 D; 3.6; 3.6 4WD	set-11	ott-14	5	AB6078AT	-	MB 236.14

Marca / Brand:	Modello / Model:	Versioni / Version:	Da anno / From:	Ad anno / To:	Marce / Gears:	Codice AB PARTS		Lubrificante Consigliato
LANCIA	VOYAGER MPV / Space wagon (404_)	2.8 CRD; 3.6 V6; 3.6 V6 LPG	set-11	dic-14	6	AB6022AT	-	MOPAR ATF +4
LAND ROVER	DEFENDER Station Wagon (L663)	D200 MHEV 4x4; D200 SD4 4x4; D240 SD4 4x4; D250 MHEV 4x4; D300 MHEV 4x4; P300 MHEV 4x4; P300 Si4 4x4; P400 I6 MHEV 4x4; P400e Hybrid 4x4; P500 4x4; P525 4x4	set-19	In produzione	8	AB6164AT	-	ZF Lifeguard Fluid 8
LAND ROVER	DEFENDER Van (L663)	2.0 D200 SD4 4x4; 2.0 D240 SD4 4x4; 2.0 P300 Si4 4x4; 2.0 P400e Hybrid 4x4; 3.0 D200 MHEV 4x4; 3.0 D250 MHEV 4x4; 3.0 D300 MHEV 4x4; 3.0 P400 I6 MHEV 4x4	feb-20	In produzione	8	AB6164AT	-	ZF Lifeguard Fluid 8
LAND ROVER	DISCOVERY I (LJ)	2.0 16 V 4x4; 4.0 4x4	giu-89	ott-98	4	AB6146AT	-	DEXRON III
LAND ROVER	DISCOVERY III (L319)	2.7 TD 4x4; 4.0 V6 4x4; 4.4 4x4	lug-04	set-09	6	AB6163AT	-	ZF Lifeguard Fluid 6
LAND ROVER	DISCOVERY IV (L319)	2.7 TD 4x4; 3.0 4x4; 3.0 SDV6 4x4; 3.0 TD 4x4; 5.0 V8 4x4	set-09	dic-18	8	AB6164AT	-	ZF Lifeguard Fluid 8
LAND ROVER	DISCOVERY IV (L319)	2.7 TD 4x4; 3.0 4x4; 3.0 SDV6 4x4; 3.0 TD 4x4; 5.0 V8 4x4	set-09	dic-18	6	AB6163AT	-	ZF Lifeguard Fluid 6
LAND ROVER	DISCOVERY IV (L319)	3.0 4x4	ago-13	dic-18	9	AB6176AT	-	ZF Lifeguard Fluid 9
LAND ROVER	DISCOVERY IV VAN (L319)	3.0 TD 4x4	gen-11	dic-17	8	AB6164AT	-	ZF Lifeguard Fluid 8
LAND ROVER	DISCOVERY V (L462)	2.0 Sd4 4x4; 2.0 Si4 4x4; 2.0 Td4 4x4; 3.0 D 4x4; 3.0 D250 MHEV 4x4; 3.0 D300 MHEV 4x4; 3.0 P360 MHEV 4x4; 3.0 SCV6 4x4; 3.0 SDV6 4x4; 3.0 Td6 4x4	set-16	In produzione	8	AB6164AT	-	ZF Lifeguard Fluid 8
LAND ROVER	DISCOVERY V VAN (L462)	2.0 Sd4 4x4; 2.0 Si4 4x4; 2.0 Td4 4x4; 3.0 D300 MHEV 4x4; 3.0 Scv6 4x4; 3.0 Sdv6 4x4; 3.0 Td6 4x4	set-16	In produzione	8	AB6164AT	-	ZF Lifeguard Fluid 8
LAND ROVER	RANGE ROVER EVOQUE (L551)	2.0 D240 MHEV 4x4	dic-18	In produzione	8	AB6164AT	-	ZF Lifeguard Fluid 8
LAND ROVER	RANGE ROVER I	3.5 4x4	lug-70	ago-81	4	AB6146AT	-	DEXRON III
LAND ROVER	RANGE ROVER II (P38A)	2.5 D 4x4; 3.9 4x4; 4.0 4x4; 4.6 4x4	lug-94	mar-02	4	AB6146AT	-	DEXRON III
LAND ROVER	RANGE ROVER III (L322)	3.0 D 4x4; 3.6 D 4x4; 4.2 4x4; 4.4 4x4; 4.4 D 4x4; 5.0 4x4	mar-02	ago-12	8	AB6164AT	-	ZF Lifeguard Fluid 8
LAND ROVER	RANGE ROVER III (L322)	3.0 D 4x4; 3.6 D 4x4; 4.2 4x4; 4.4 4x4; 4.4 D 4x4; 5.0 4x4	mar-02	ago-12	6	AB6163AT	-	ZF Lifeguard Fluid 6
LAND ROVER	RANGE ROVER III (L322)	3.0 D 4x4; 3.6 D 4x4; 4.2 4x4; 4.4 4x4; 4.4 D 4x4; 5.0 4x4	mar-02	ago-12	5	AB6151AT	-	ESSO LT 71141
LAND ROVER	RANGE ROVER III (L322)	3.0 D 4x4; 4.4 4x4	mar-02	ago-12	4	AB6146AT	-	DEXRON III
LAND ROVER	RANGE ROVER IV (L405)	2.0 P400e Hybrid 4x4; 3.0 P400 4x4; 3.0 P400 MHEV 4x4; 3.0 SCV6 4x4; 3.0 SDV6 4x4; 3.0 SDV6 Hybrid 4x4; 3.0 TDV6 4x4; 4.4 SDV8 4x4; 5.0 SCV8 4x4; 5.0 V8 4x4; P360 MHEV 4x4	ago-12	In produzione	8	AB6164AT	-	ZF Lifeguard Fluid 8
LAND ROVER	RANGE ROVER IV (L405)	3.0 SDV6 4x4	ago-12	In produzione	6	AB6163AT	-	ZF Lifeguard Fluid 6
LAND ROVER	RANGE ROVER IV (L405)	3.0 SDV6 4x4	ago-12	In produzione	5	AB6151AT	-	ESSO LT 71141
LAND ROVER	RANGE ROVER SPORT I (L320)	2.7 D 4x4; 3.0 D 4x4; 3.6 D 4x4; 4.2 4x4; 4.4 4x4; 5.0 4x4	feb-05	mar-13	6	AB6163AT	-	ZF Lifeguard Fluid 6
LAND ROVER	RANGE ROVER SPORT I (L320)	4.4 4x4; 5.0 4x4	feb-05	mar-13	8	AB6164AT	-	ZF Lifeguard Fluid 8
LAND ROVER	RANGE ROVER SPORT II (L494)	2.0 P400e PHEV 4x4; 2.0 SD4 4x4; 2.0 Si4 4x4; 3.0 D250 4x4; 3.0 D250 MHEV 4x4; 3.0 D300 4x4; 3.0 D300 MHEV 4x4; 3.0 D350 4x4; 3.0 D350 MHEV 4x4; 3.0 P400 MHEV 4x4; 3.0 SCV6 4x4; 3.0 SDV6 4x4; 3.0 SDV6 Hybrid 4x4; 3.0 TDV6 4x4; 4.4 SDV8 4x4; 5.0 SCV8 4x4	apr-13	In produzione	8	AB6164AT	-	ZF Lifeguard Fluid 8
LAND ROVER	RANGE ROVER SPORT III (L461)	3.0 D250 MHEV AWD; 3.0 D300 MHEV AWD; 3.0 D350 MHEV AWD; P400 MHEV AWD; P440e PHEV AWD; P460e PHEV AWD; P510e PHEV AWD; P530 AWD; P530 MHEV AWD; P550e PHEV AWD; P635 MHEV AWD	apr-22	In produzione	8	AB6164AT	-	ZF Lifeguard Fluid 8
LAND ROVER	RANGE ROVER V (L460)	D250 MHEV AWD; D300 MHEV AWD; D350 MHEV AWD; P400 MHEV AWD; P440e PHEV AWD; P460e PHEV AWD; P510e PHEV AWD; P530 AWD; P530 MHEV AWD; P550e PHEV AWD	ott-21	In produzione	8	AB6164AT	-	ZF Lifeguard Fluid 8
LAND ROVER	RANGE ROVER VELAR (L560)	2.0 D165 MHEV 4x4; 2.0 D180 TD4 4x4; 2.0 D200 4x4; 2.0 D200 MHEV 4x4; 2.0 D240 SD4 4x4; 2.0 P250 Si4 4x4; 2.0 P300 Si4 4x4; 2.0 P400 Hybrid 4x4; 3.0 D275 SDV6 4x4; 3.0 D300 MHEV 4x4; 3.0 D300 SDV6 4x4; 3.0 P380 SCV6 4x4; 3.0 P400 MHEV 4x4	mar-17	In produzione	8	AB6164AT	-	ZF Lifeguard Fluid 8
LEXUS	ES (_V4_)	3.5	mag-06	giu-12	6	AB6131AT	-	Toyota ATF WS

Marca / Brand:	Modello / Model:	Versioni / Version:	Da anno / From:	Ad anno / To:	Marce / Gears:	Codice AB PARTS		Lubrificante Consigliato
LEXUS	GX (_J12_)	470	nov-01	nov-09	5	AB6122AT	-	Toyota ATF WS
LEXUS	GX (URJ15_, GRJ15_)	460 4WD	gen-10	In produzione	6	AB6123AT	-	Toyota ATF WS
LEXUS	LX (_J2_)	570	ago-07	In produzione	6	AB6123AT	-	Toyota ATF WS
LEXUS	LX (UZJ100)	470	mag-98	mar-08	5	AB6122AT	-	Toyota ATF WS
LEXUS	NX (_Z1_)	200t; 200t AWD	lug-14	In produzione	6	AB6131AT	-	Toyota ATF WS
LEXUS	RX (_L1_)	350; 350 AWD	dic-08	ott-15	6	AB6131AT	-	Toyota ATF WS
LEXUS	UX (_AA1_, _AH1_, _MA1_)	200	ott-18	In produzione	CVT	AB6125AT + AT3126AT	-	Toyota CVT FLUID FE
MAN	TGE Autobus	2.0 TDI; 2.0 TDI AWD; 2.0 TDI RWD	feb-17	In produzione	8	AB6140AT	-	VW G055540A2
MAN	TGE Furgone	2.0 TDI RWD	mag-17	giu-24	8	AB6164AT	-	ZF Lifeguard Fluid 8
MAN	TGE Furgone	2.0 TDI; 2.0 TDI AWD; 2.0 TDI RWD	feb-17	In produzione	8	AB6140AT	-	VW G055540A2
MAN	TGE Pianale piatto/Telaio (UZ_)	2.0 TDI RWD	lug-17	giu-24	8	AB6164AT	-	ZF Lifeguard Fluid 8
MAN	TGE Pianale piatto/Telaio (UZ_)	2.0 TDI; 2.0 TDI AWD; 2.0 TDI RWD	nov-16	In produzione	8	AB6140AT	-	VW G055540A2
MASERATI	GHIBLI III (M157)	3.0; 3.0 D; 3.0 S; 3.0 S Q4	ago-13	In produzione	8	AB6164AT	-	ZF Lifeguard Fluid 8
MASERATI	LEVANTE SUV (M161)	3.0 D Q4; 3.0 Q4; 3.0 S Q4	giu-16	In produzione	8	AB6164AT	-	ZF Lifeguard Fluid 8
MASERATI	QUATTROPORTE V	4.7 GT S; 4.7 S	giu-08	In produzione	8	AB6164AT	-	ZF Lifeguard Fluid 8
MASERATI	QUATTROPORTE VI	3.0; 3.0 D; 3.0 S; 3.0 S Q4; 3.8 GT S	gen-13	In produzione	8	AB6164AT	-	ZF Lifeguard Fluid 8
MAZDA	2 Hatchback (DL, DJ)	1.5 D	ago-14	In produzione	6	AB6074AT	-	MAZDA ATF FZ Skyactiv
MAZDA	2 Hatchback (DL, DJ)	1.5; 1.5 SKYACTIV-G	ago-14	In produzione	6	AB6075AT	-	MAZDA ATF FZ Skyactiv
MAZDA	3 (BK)	1.3; 1.6; 1.6 DI Turbo; 1.6 MZ-CD; 2.0; 2.0 MZR-CD; 2.3 DiSi Turbo MPS; 2.3 MPS Turbo	ott-03	dic-09	4	AB6033AT	-	MERCON V
MAZDA	3 (BK)	1.3; 1.6; 1.6 DI Turbo; 2.0; 2.0 MZR-CD; 2.3 DiSi Turbo MPS; 2.3 MPS Turbo	ott-03	dic-09	4 / 5	AB6034AT	-	MERCON V
MAZDA	3 (BL)	1.6 MZR; 2.0 MZR; 2.0 MZR DISI; 2.5	dic-08	set-14	6	AB6074AT	-	MAZDA ATF FZ Skyactiv
MAZDA	3 (BM, BN)	1.5	ott-13	mag-19	6	AB6075AT	-	MAZDA ATF FZ Skyactiv
MAZDA	3 (BM, BN)	1.5; 2.0; 2.2 D	lug-13	mag-19	6	AB6074AT	-	MAZDA ATF FZ Skyactiv
MAZDA	3 Hatchback (BP)	1.5 SKYACTIV-G	nov-18	In produzione	6	AB6075AT	-	MAZDA ATF FZ Skyactiv
MAZDA	3 Hatchback (BP)	1.8 SKYACTIV-D; 2.0 SKYACTIV-G M Hybrid	nov-18	In produzione	6	AB6074AT	-	MAZDA ATF FZ Skyactiv
MAZDA	3 Tre volumi (BK)	1.6; 1.6 DI Turbo; 2.0; 2.0 MZR-CD	ott-03	dic-09	4	AB6033AT	-	MERCON V
MAZDA	3 Tre volumi (BK)	1.6; 1.6 DI Turbo; 2.0; 2.0 MZR-CD	ott-03	dic-09	4 / 5	AB6034AT	-	MERCON V
MAZDA	3 Tre volumi (BL)	1.6 MZR; 2.0; 2.0 MZR; 2.0 MZR DISI	dic-08	set-14	6	AB6074AT	-	MAZDA ATF FZ Skyactiv
MAZDA	3 Tre volumi (BM_, BN_)	1.5	ott-13	mag-19	6	AB6075AT	-	MAZDA ATF FZ Skyactiv
MAZDA	3 Tre volumi (BM_, BN_)	1.5; 2.0	set-13	mag-19	6	AB6074AT	-	MAZDA ATF FZ Skyactiv
MAZDA	3 Tre volumi (BP_)	1.5 SKYACTIV-G	nov-18	In produzione	6	AB6075AT	-	MAZDA ATF FZ Skyactiv
MAZDA	323 F VI Hatchback (BJ)	1.5 16V; 1.6; 1.9 16V; 2.0	set-98	mag-04	4	AB6033AT	-	MERCON V
MAZDA	323 F VI Hatchback (BJ)	1.5 16V; 1.6; 1.9 16V; 2.0	set-98	mag-04	4 / 5	AB6034AT	-	MERCON V
MAZDA	323 II Hatchback (BD)	1.5	mar-82	dic-85	4	AB6033AT	-	MERCON V
MAZDA	323 S VI Tre volumi (BJ)	1.5 16V; 1.6; 1.9 16V	set-98	mag-04	4	AB6033AT	-	MERCON V
MAZDA	323 S VI Tre volumi (BJ)	1.5 16V; 1.6; 1.9 16V; 2.0	set-98	mag-04	4 / 5	AB6034AT	-	MERCON V
MAZDA	5 (CR19)	2.0	feb-05	mag-10	4	AB6033AT	-	MERCON V
MAZDA	5 (CR19)	2.0	feb-05	mag-10	4 / 5	AB6034AT	-	MERCON V

Marca / Brand:	Modello / Model:	Versioni / Version:	Da anno / From:	Ad anno / To:	Marce / Gears:	Codice AB PARTS		Lubrificante Consigliato
MAZDA	6 Familiare (GJ, GL)	2.0; 2.2 D; 2.2 D AWD; 2.5	ago-12	In produzione	6	AB6074AT	-	MAZDA ATF FZ Skyactiv
MAZDA	6 Hatchback (GG)	1.8; 2.0; 2.0 Di; 2.3	ago-02	ago-07	4	AB6033AT	-	MERCON V
MAZDA	6 Hatchback (GG)	1.8; 2.0; 2.0 Di; 2.3	ago-02	ago-07	4 / 5	AB6034AT	-	MERCON V
MAZDA	6 Station Wagon (GY)	1.8; 2.0; 2.0 Di; 2.3; 2.3 AWD	gen-02	feb-08	4	AB6033AT	-	MERCON V
MAZDA	6 Station Wagon (GY)	1.8; 2.0; 2.0 Di; 2.3; 2.3 AWD	gen-02	feb-08	4 / 5	AB6034AT	-	MERCON V
MAZDA	6 Station Wagon (GY)	2.3 AWD	nov-02	ago-07	5	AB6070AT	-	ATF Type K17
MAZDA	6 Tre volumi (GG)	1.8; 2.0; 2.0 Di; 2.3; 2.3 MPS Turbo	giu-02	ago-07	4	AB6033AT	-	MERCON V
MAZDA	6 Tre volumi (GG)	1.8; 2.0; 2.0 Di; 2.3; 2.3 MPS Turbo	giu-02	ago-07	4 / 5	AB6034AT	-	MERCON V
MAZDA	6 Tre volumi (GJ, GL)	2.0; 2.2 D; 2.5	dic-12	In produzione	6	AB6074AT	-	MAZDA ATF FZ Skyactiv
MAZDA	CX-3 (DK)	1.5 SKYACTIV-D; 1.5 SKYACTIV-D AWD; 1.8 SKYACTIV-D; 1.8 SKYACTIV-D AWD; 2.0 SKYACTIV-G; 2.0 SKYACTIV-G AWD	feb-15	In produzione	6	AB6074AT	-	MAZDA ATF FZ Skyactiv
MAZDA	CX-30 (DM)	1.8 SKYACTIV-D; 1.8 SKYACTIV-D AWD; SKYACTIV-G M Hybrid; SKYACTIV-G M Hybrid AWD; SKYACTIV-X M Hybrid; SKYACTIV-X M Hybrid AWD	lug-19	In produzione	6	AB6074AT	-	MAZDA ATF FZ Skyactiv
MAZDA	CX-5 (KE, GH)	2.0; 2.0 AWD; 2.2 D; 2.2 D AWD; 2.5 AWD	nov-11	feb-17	6	AB6074AT	-	MAZDA ATF FZ Skyactiv
MAZDA	CX-5 (KF)	2.0; 2.0 AWD; 2.0 SKYACTIV-G; 2.0 SKYACTIV-G AWD; 2.2 D; 2.2 D AWD; 2.5; 2.5 AWD	nov-16	In produzione	6	AB6074AT	-	MAZDA ATF FZ Skyactiv
MAZDA	CX-5 Van (KE_)	SKYACTIV-D; SKYACTIV-D AWD; SKYACTIV-G AWD	apr-15	feb-17	6	AB6074AT	-	MAZDA ATF FZ Skyactiv
MAZDA	CX-9 (TC)	2.5 T AWD	giu-16	In produzione	6	AB6074AT	-	MAZDA ATF FZ Skyactiv
MAZDA	MPV II (LW)	2.5 V6; 3.0 i V6	set-99	dic-06	5	AB6070AT	-	ATF Type K17
MAZDA	PREMACY (CP)	1.9; 2.0	lug-99	mar-05	4	AB6033AT	-	MERCON V
MAZDA	PREMACY (CP)	1.9; 2.0	lug-99	mar-05	4 / 5	AB6034AT	-	MERCON V
MAZDA	PREMACY Van (CP_)	1.8; 2.0	lug-99	giu-05	4	AB6033AT	-	MERCON V
MERCEDES-BENZ	123 Coupé (C123)	230 CE; 280 CE; 300 C Turbo-D	mar-77	dic-85	4	AB6076AT	-	MB A0009899203
MERCEDES-BENZ	123 T-Model (S123)	200 T; 230 TE; 240 T D; 280 TE; 300 T D; 300 T Turbo-D	set-77	dic-85	4	AB6076AT	-	MB A0009899203
MERCEDES-BENZ	123 T-Model (S123)	300 T D	set-77	ott-85	5	AB6078AT	-	MB 236.14
MERCEDES-BENZ	123 Tre volumi (W123)	200; 200 D; 230 E; 240 D; 250; 280 E; 300 D; 300 Turbo-D	feb-76	dic-85	4	AB6076AT	-	MB A0009899203
MERCEDES-BENZ	123 Tre volumi (W123)	300 D	feb-76	lug-80	5	AB6078AT	-	MB 236.14
MERCEDES-BENZ	124 Cabriolet (A124)	300 CE-24	apr-92	giu-93	5	AB6078AT	-	MB 236.14
MERCEDES-BENZ	124 Cabriolet (A124)	300 CE-24; 320 CE	apr-92	giu-93	4	AB6076AT	-	MB A0009899203
MERCEDES-BENZ	124 Cabriolet (A124)	300 CE-24; 320 CE	apr-92	giu-93	4	AB6077AT	-	DEXRON III
MERCEDES-BENZ	124 Coupé (C124)	200 CE; 220 CE; 230 CE; 230 CE Cat; 300 CE; 300 CE-24; 320 CE	mar-87	lug-93	4	AB6076AT	-	MB A0009899203
MERCEDES-BENZ	124 Coupé (C124)	200 CE; 220 CE; 230 CE; 230 CE Cat; 300 CE; 300 CE-24; 320 CE	mar-87	lug-93	4	AB6077AT	-	DEXRON III
MERCEDES-BENZ	124 T-Model (S124)	200 T; 200 T D; 200 TE; 220 TE; 230 TE; 230 TE Cat; 250 T D; 250 TD Turbo; 260 TE FGST.; 280 TE; 300 T D; 300 T Turbo-D; 300 T Turbo-D 4-matic; 300 TE; 300 TE 4-matic; 300 TE-24; 320 TE	set-85	lug-93	4	AB6076AT	-	MB A0009899203
MERCEDES-BENZ	124 T-Model (S124)	200 T; 200 T D; 200 TE; 220 TE; 230 TE; 230 TE Cat; 250 T D; 250 TD Turbo; 260 TE FGST.; 280 TE; 300 T D; 300 T Turbo-D; 300 T Turbo-D 4-matic; 300 TE; 300 TE 4-matic; 300 TE-24; 320 TE	set-85	lug-93	4	AB6077AT	-	DEXRON III
MERCEDES-BENZ	124 T-Model (S124)	320 TE	ott-92	giu-93	7	AB6177AT	-	MB 236.15
MERCEDES-BENZ	124 Tre volumi (W124)	200; 200 D; 200 E; 220 E; 230 E; 230 E Cat; 250 D; 250 Turbo-D; 260 E; 260 E 4-matic; 280 E; 300 D; 300 D 4-matic; 300 E; 300 E 4-matic; 300 E-24; 300 Turbo-D; 300 Turbo-D 4-matic; 320 E; 400 E 4.2; 500 E	dic-84	ago-93	4	AB6076AT	-	MB A0009899203

Marca / Brand:	Modello / Model:	Versioni / Version:	Da anno / From:	Ad anno / To:	Marce / Gears:	Codice AB PARTS		Lubrificante Consigliato
MERCEDES-BENZ	124 Tre volumi (W124)	200; 200 D; 200 E; 220 E; 230 E; 230 E Cat; 250 D; 250 Turbo-D; 260 E; 260 E 4-matic; 280 E; 300 D; 300 D 4-matic; 300 E; 300 E 4-matic; 300 E-24; 300 Turbo-D; 300 Turbo-D 4-matic; 320 E; 400 E 4.2; 500 E	dic-84	ago-93	4	AB6077AT	-	DEXRON III
MERCEDES-BENZ	124 Tre volumi (W124)	300 E-24	set-88	ago-92	5	AB6078AT	-	MB 236.14
MERCEDES-BENZ	124 Tre volumi (W124)	320 E	ott-92	giu-93	7	AB6177AT	-	MB 236.15
MERCEDES-BENZ	190 (W201)	190 D; 2.0; 2.6; D 2.0; D 2.5; E 1.8; E 2.0; E 2.3; E 2.3-16; E 2.5-16; E 2.5-16 Evolution; E 2.5-16 Evolution II; E 2.6; Turbo-D 2.5	ott-82	ago-93	4	AB6076AT	-	MB A000989203
MERCEDES-BENZ	AMG GT (X290)	4.0 63 S E Performance 4-matic+; 63 4-matic+; 63 S 4-matic+	lug-18	In produzione	9	AB6086AT	-	MB 236.16
MERCEDES-BENZ	AMG GT (X290)	43 EQ Boost; 43 EQ Boost 4-matic+; 53 EQ Boost 4-matic+	set-18	In produzione	9	AB6088AT	-	MB 236.16
MERCEDES-BENZ	CLA (C118)	AMG CLA 35 4-matic; AMG CLA 35 Mild-Hybrid 4-matic; CLA 220; CLA 220 4-matic; CLA 220 Mild-Hybrid 4-matic; CLA 250; CLA 250 4-matic; CLA 250 Mild-Hybrid 4-matic	mar-19	In produzione	7	AB6080AT + AB6081AT	-	MB 236.21
MERCEDES-BENZ	CLA Coupé (C117)	CLA 220 CDI; CLA 220 CDI 4x4; AMG CLA 45 4-matic; CLA 180; CLA 180 CDI; CLA 200; CLA 200 CDI; CLA 220 4-matic; CLA 220 CDI 4-matic; CLA 250; CLA 250 4-matic; CLA 45 AMG 4-matic	gen-13	mar-19	7	AB6080AT + AB6081AT	-	MB 236.21
MERCEDES-BENZ	CLA Shooting Brake (X117)	CLA 200 CDI; CLA 220 CDI; CLA 200 CDI 4x4; CLA 220 CDI 4x4; AMG CLA 45 4-matic; CLA 180; CLA 180 d; CLA 200; CLA 220 4-matic; CLA 220 d; CLA 220 d 4-matic; CLA 250; CLA 250 4-matic; CLA 45 AMG 4-matic	gen-15	mar-19	7	AB6080AT + AB6081AT	-	MB 236.21
MERCEDES-BENZ	CLA Shooting Brake (X118)	AMG CLA 35 4-matic; AMG CLA 35 Mild-Hybrid 4-matic; CLA 220; CLA 250; CLA 250 4-matic; CLA 250 Mild-Hybrid 4-matic	giu-19	In produzione	7	AB6080AT + AB6081AT	-	MB 236.21
MERCEDES-BENZ	CLASSE A (W168)	A 140; A 160; A 160 CDI; A 170 CDI; A 190; A 210	lug-97	ago-04	5	AB6089AT	-	MB 236.12
MERCEDES-BENZ	CLASSE A (W169)	A 150; A 160; A 160 CDI; A 170; A 180; A 180 CDI; A 200; A 200 CDI; A 200 TURBO	set-04	giu-12	CVT	AB6090AT *	AB6091AT *	MB 236.20
MERCEDES-BENZ	CLASSE A (W176)	A 160 CDI; A 180 CDI; A 200 CDI; A 200 CDI 4x4; A 160; A 180; A 200; A 220 4-matic; A 220 CDI; A 220 CDI 4-matic; A 220 d; A 220 d 4-matic; A 250; A 250 4-matic; A 45 AMG 4-matic; AMG A 45 4-matic	giu-12	mag-18	7	AB6080AT + AB6081AT	-	MB 236.21
MERCEDES-BENZ	CLASSE A (W177)	A 220; A 220 4-matic; A 250; A 250 4-matic; AMG A 35 4-matic	mar-18	In produzione	7	AB6080AT + AB6081AT	-	MB 236.21
MERCEDES-BENZ	CLASSE A Tre volumi (V177)	A 220; A 220 4-matic; A 250; A 250 4-matic; AMG A 35 4-matic	set-18	In produzione	7	AB6080AT + AB6081AT	-	MB 236.21
MERCEDES-BENZ	CLASSE B Sports Tourer (W245)	B 150; B 160; B 170; B 170 NGT; B 180; B 180 CDI; B 180 NGT; B 200; B 200 CDI; B 200 TURBO	mar-05	nov-11	CVT	AB6090AT *	AB6091AT *	MB 236.20
MERCEDES-BENZ	CLASSE B Sports Tourer (W246, W242)	B 200 Natural Gas Drive; B 160 CDI; B 180 CDI; B 200 CDI; B 220 CDI; B 200 CDI 4x4; B 220 CDI 4x4; B 160; B 180; B 200; B 220 4-matic; B 220 d 4-matic; B 250; B 250 4-matic	nov-11	dic-18	7	AB6080AT + AB6081AT	-	MB 236.21
MERCEDES-BENZ	CLASSE B Sports Tourer (W247)	B 220; B 220 4-matic; B 250; B 250 4-matic	gen-19	In produzione	7	AB6080AT + AB6081AT	-	MB 236.21
MERCEDES-BENZ	CLASSE C (W202)	C 180; C 200; C 200 CDI; C 200 D; C 200 Kompressor; C 220; C 220 CDI; C 220 D; C 230; C 230 Kompressor; C 240; C 250 D; C 250 Turbo-D; C 280; C 36 AMG; C 43 AMG	mar-93	mag-00	5	AB6078AT	-	MB 236.14
MERCEDES-BENZ	CLASSE C (W202)	C 180; C 200; C 200 D; C 200 Kompressor; C 220; C 220 D; C 230; C 230 Kompressor; C 250 D; C 250 Turbo-D; C 280; C 36 AMG	mar-93	mag-00	4	AB6076AT	-	MB A000989203
MERCEDES-BENZ	CLASSE C (W203)	C 180; C 180 Kompressor; C 200 CDI; C 200 CGI Kompressor; C 200 Kompressor; C 220 CDI; C 230; C 230 Kompressor; C 240; C 240 4-matic; C 270 CDI; C 280; C 280 4-matic; C 30 CDI AMG; C 32 AMG Kompressor; C 320; C 320 4-matic; C 320 CDI; C 350; C 350 4-matic; C 55 AMG	mag-00	feb-07	5	AB6078AT	-	MB 236.14

Marca / Brand:	Modello / Model:	Versioni / Version:	Da anno / From:	Ad anno / To:	Marce / Gears:	Codice AB PARTS		Lubrificante Consigliato
MERCEDES-BENZ	CLASSE C (W203)	C 180; C 180 Kompressor; C 200 CDI; C 200 CGI Kompressor; C 200 Kompressor; C 220 CDI; C 230; C 230 Kompressor; C 240; C 240 4-matic; C 270 CDI; C 280; C 280 4-matic; C 300 CDI AMG; C 32 AMG Kompressor; C 320; C 320 4-matic; C 320 CDI; C 350; C 350 4-matic; C 55 AMG	mag-00	feb-07	7	AB6177AT	-	MB 236.15
MERCEDES-BENZ	CLASSE C (W203)	C 230; C 280; C 280 4-matic; C 320 CDI; C 350; C 350 4-matic	gen-05	feb-07	7	AB6082AT	-	MB 236.21
MERCEDES-BENZ	CLASSE C (W203)	C 230; C 280; C 320 CDI; C 350	gen-05	feb-07	7	AB6083AT	-	MB 236.21
MERCEDES-BENZ	CLASSE C (W203)	C 230; C 280; C 320 CDI; C 350	gen-05	feb-07	7	AB6084AT	-	MB 236.21
MERCEDES-BENZ	CLASSE C (W204)	C 180 CDI; C 180 CGI; C 180 Kompressor; C 200; C 200 CDI; C 200 CGI; C 200 Kompressor; C 220 CDI; C 220 CDI 4-matic; C 230; C 230 4-matic; C 250 CDI; C 250 CDI 4-matic; C 250 CGI; C 280; C 280 4-matic; C 300; C 300 4-matic; C 300 CDI 4-matic; C 320 CDI; C 320 CDI 4-matic; C 350; C 350 4-matic; C 350 CDI; C 350 CDI 4-matic; C 350 CGI; C 63 AMG; C 63 AMG DR 520	gen-07	mar-14	5	AB6078AT	-	MB 236.14
MERCEDES-BENZ	CLASSE C (W204)	C 180 CDI; C 180 CGI; C 180 Kompressor; C 200; C 200 CDI; C 200 CGI; C 200 Kompressor; C 220 CDI; C 220 CDI 4-matic; C 230; C 230 4-matic; C 250 CDI; C 250 CDI 4-matic; C 250 CGI; C 280; C 280 4-matic; C 300; C 300 4-matic; C 300 CDI 4-matic; C 320 CDI; C 320 CDI 4-matic; C 350; C 350 4-matic; C 350 CDI; C 350 CDI 4-matic; C 350 CGI; C 63 AMG; C 63 AMG DR 520	gen-07	mar-14	7	AB6083AT	-	MB 236.21
MERCEDES-BENZ	CLASSE C (W204)	C 180 CDI; C 180 CGI; C 180 Kompressor; C 200; C 200 CDI; C 200 CGI; C 200 Kompressor; C 220 CDI; C 220 CDI 4-matic; C 230; C 230 4-matic; C 250 CDI; C 250 CDI 4-matic; C 250 CGI; C 280; C 280 4-matic; C 300; C 300 4-matic; C 300 CDI 4-matic; C 320 CDI; C 320 CDI 4-matic; C 350; C 350 4-matic; C 350 CDI; C 350 CDI 4-matic; C 350 CGI; C 63 AMG; C 63 AMG DR 520	gen-07	mar-14	7	AB6084AT	-	MB 236.21
MERCEDES-BENZ	CLASSE C (W204)	C 180 CDI; C 180 CGI; C 180 Kompressor; C 200; C 200 CDI; C 200 CGI; C 200 Kompressor; C 220 CDI; C 220 CDI 4-matic; C 230; C 230 4-matic; C 250 CDI; C 250 CDI 4-matic; C 250 CGI; C 280; C 280 4-matic; C 300; C 300 4-matic; C 300 CDI 4-matic; C 320 CDI; C 320 CDI 4-matic; C 350; C 350 4-matic; C 350 CDI; C 350 CDI 4-matic; C 350 CGI; C 63 AMG; C 63 AMG DR 520	gen-07	mar-14	7	AB6177AT	-	MB 236.15
MERCEDES-BENZ	CLASSE C (W204)	C 180 CDI; C 200 CDI	nov-09	mar-14	7	AB6082AT	-	MB 236.21
MERCEDES-BENZ	CLASSE C (W205)	AMG C 63; AMG C 63 S; C 300 4-matic; C 300 EQ Boost 4-matic	ott-14	mag-21	9	AB6086AT	-	MB 236.16
MERCEDES-BENZ	CLASSE C (W205)	C 180 BlueTEC; C 200 BlueTEC; C 220 BlueTEC; C 250 BlueTEC; C 250 BlueTEC 4x4; AMG C 43 4-matic; AMG C 63; AMG C 63 S; C 160; C 180; C 200; C 200 4-matic; C 200 d; C 220 d 4-matic; C 250; C 300; C 300 4-matic; C 350 e; C 400 4-matic; C 450 AMG 4-matic	dic-13	mag-21	7	AB6083AT	-	MB 236.21
MERCEDES-BENZ	CLASSE C (W205)	C 180 BlueTEC; C 200 BlueTEC; C 220 BlueTEC; C 250 BlueTEC; C 300 BlueTEC Hybrid; C 250 BlueTEC 4x4; AMG C 43 4-matic; AMG C 63; AMG C 63 S; C 160; C 180; C 180 d; C 200; C 200 4-matic; C 200 d; C 200 EQ Boost; C 200 EQ Boost 4-matic; C 220 d; C 220 d 4-matic; C 250; C 300; C 300 4-matic; C 300 d; C 300 d 4-matic; C 300 de; C 300 e; C 300 e 4-matic; C 300 EQ Boost; C 300 EQ Boost 4-matic; C 350 e; C 400 4-matic; C 450 AMG 4-matic	dic-13	giu-21	7	AB6177AT	-	MB 236.15
MERCEDES-BENZ	CLASSE C (W205)	C 220 BlueTEC; C 250 BlueTEC; C 250 BlueTEC 4x4; AMG C 43 4-matic; AMG C 63; AMG C 63 S; C 160; C 180; C 200; C 200 4-matic; C 200 d; C 220 d 4-matic; C 250; C 300; C 300 4-matic; C 350 e; C 400 4-matic; C 450 AMG 4-matic	dic-13	mag-21	7	AB6082AT	-	MB 236.21
MERCEDES-BENZ	CLASSE C (W205)	C 220 BlueTEC; C 250 BlueTEC; C 250 BlueTEC 4x4; AMG C 43 4-matic; AMG C 63; AMG C 63 S; C 160; C 180; C 200; C 200 d; C 220 d 4-matic; C 250; C 300; C 300 4-matic; C 450 AMG 4-matic	dic-13	mag-21	7	AB6084AT	-	MB 236.21

Marca / Brand:	Modello / Model:	Versioni / Version:	Da anno / From:	Ad anno / To:	Marce / Gears:	Codice AB PARTS		Lubrificante Consigliato
MERCEDES-BENZ	CLASSE C (W205)	C 220 BlueTEC; C 250 BlueTEC; C 300 BlueTEC Hybrid; C 250 BlueTEC 4x4; AMG C 43 4-matic; C 160; C 180; C 180 d; C 200; C 200 4-matic; C 200 d; C 200 EQ Boost; C 200 EQ Boost 4-matic; C 220 d; C 220 d 4-matic; C 250; C 300; C 300 4-matic; C 300 d; C 300 d 4-matic; C 300 EQ Boost; C 300 EQ Boost 4-matic; C 400 4-matic; C 450 AMG 4-matic	dic-13	giu-21	9	AB6088AT	-	MB 236.16
MERCEDES-BENZ	CLASSE C (W205)	C 300 BlueTEC Hybrid; C 350 e	mag-14	ago-18	7	AB6085AT	-	MB236.15
MERCEDES-BENZ	CLASSE C (W205)	C 300 de; C 300 e; C 300 e 4-matic	mag-19	mag-21	9	AB6087AT	-	MB 236.16
MERCEDES-BENZ	CLASSE C (W206)	AMG C 43 4-matic+; AMG C 63 S E Performance 4-matic+; C 180; C 200; C 200 4-matic; C 200 d; C 220 d; C 220 d 4-matic; C 300; C 300 4-matic; C 300 d; C 300 d 4-matic	mar-21	In produzione	9	AB6086AT	-	MB 236.16
MERCEDES-BENZ	CLASSE C All-Terrain (S206)	C 200 4-matic; C 220 d 4-matic	dic-21	In produzione	9	AB6086AT	-	MB 236.16
MERCEDES-BENZ	CLASSE C Cabriolet (A205)	AMG C 43 4-matic; AMG C 63; AMG C 63 S; C 180; C 200; C 200 4-matic; C 200 d; C 200 EQ Boost; C 200 EQ Boost 4-matic; C 220 d; C 220 d 4-matic; C 250; C 250 d; C 300; C 300 d; C 300 EQ Boost; C 300 EQ Boost 4-matic; C 400 4-matic	giu-16	apr-23	7	AB6177AT	-	MB 236.15
MERCEDES-BENZ	CLASSE C Cabriolet (A205)	AMG C 43 4-matic; AMG C 63; AMG C 63 S; C 180; C 200; C 200 4-matic; C 220 d; C 220 d 4-matic; C 250; C 250 d; C 300; C 400 4-matic	giu-16	apr-23	7	AB6082AT	-	MB 236.21
MERCEDES-BENZ	CLASSE C Cabriolet (A205)	AMG C 43 4-matic; AMG C 63; AMG C 63 S; C 180; C 200; C 200 4-matic; C 220 d; C 220 d 4-matic; C 250; C 250 d; C 300; C 400 4-matic	giu-16	apr-23	7	AB6083AT	-	MB 236.21
MERCEDES-BENZ	CLASSE C Cabriolet (A205)	AMG C 43 4-matic; AMG C 63; AMG C 63 S; C 180; C 200; C 220 d; C 220 d 4-matic; C 250; C 250 d; C 400 4-matic	giu-16	apr-23	7	AB6084AT	-	MB 236.21
MERCEDES-BENZ	CLASSE C Cabriolet (A205)	AMG C 43 4-matic; C 180; C 200; C 200 4-matic; C 200 d; C 200 EQ Boost; C 200 EQ Boost 4-matic; C 220 d; C 220 d 4-matic; C 250; C 250 d; C 300; C 300 d; C 300 EQ Boost; C 300 EQ Boost 4-matic; C 400 4-matic	giu-16	apr-23	9	AB6088AT	-	MB 236.16
MERCEDES-BENZ	CLASSE C Cabriolet (A205)	AMG C 63; AMG C 63 S; C 250 d	giu-16	apr-23	9	AB6086AT	-	MB 236.16
MERCEDES-BENZ	CLASSE C Coupé (C204)	C 180; C 200 CGI; C 220 CDI; C 250; C 250 CDI; C 350; C 350 4-matic; C 63 AMG	giu-11	In produzione	5	AB6078AT	-	MB 236.14
MERCEDES-BENZ	CLASSE C Coupé (C204)	C 180; C 200 CGI; C 220 CDI; C 250; C 250 CDI; C 350; C 350 4-matic; C 63 AMG	giu-11	In produzione	7	AB6082AT	-	MB 236.21
MERCEDES-BENZ	CLASSE C Coupé (C204)	C 180; C 200 CGI; C 220 CDI; C 250; C 250 CDI; C 350; C 350 4-matic; C 63 AMG	giu-11	In produzione	7	AB6083AT	-	MB 236.21
MERCEDES-BENZ	CLASSE C Coupé (C204)	C 180; C 200 CGI; C 220 CDI; C 250; C 250 CDI; C 350; C 350 4-matic; C 63 AMG	giu-11	In produzione	7	AB6084AT	-	MB 236.21
MERCEDES-BENZ	CLASSE C Coupé (C204)	C 180; C 200 CGI; C 220 CDI; C 250; C 250 CDI; C 350; C 350 4-matic; C 63 AMG	giu-11	In produzione	7	AB6177AT	-	MB 236.15
MERCEDES-BENZ	CLASSE C Coupé (C205)	AMG C 43 4-matic; AMG C 63; AMG C 63 S; C 180; C 200; C 200 4-matic; C 200 d; C 200 EQ Boost; C 200 EQ Boost 4-matic; C 220 d; C 220 d 4-matic; C 250; C 250 d; C 250 d 4-matic; C 300; C 300 4-matic; C 300 d; C 300 d 4-matic; C 300 EQ Boost; C 300 EQ Boost 4-matic; C 400 4-matic	ott-15	apr-23	7	AB6177AT	-	MB 236.15
MERCEDES-BENZ	CLASSE C Coupé (C205)	AMG C 43 4-matic; AMG C 63; AMG C 63 S; C 180; C 200; C 200 4-matic; C 220 d; C 220 d 4-matic; C 250; C 250 d; C 250 d 4-matic; C 300; C 400 4-matic	ott-15	apr-23	7	AB6082AT	-	MB 236.21
MERCEDES-BENZ	CLASSE C Coupé (C205)	AMG C 43 4-matic; AMG C 63; AMG C 63 S; C 180; C 200; C 200 4-matic; C 220 d; C 220 d 4-matic; C 250; C 250 d; C 250 d 4-matic; C 300; C 400 4-matic	ott-15	apr-23	7	AB6083AT	-	MB 236.21
MERCEDES-BENZ	CLASSE C Coupé (C205)	AMG C 43 4-matic; AMG C 63; AMG C 63 S; C 180; C 200; C 220 d; C 220 d 4-matic; C 250; C 250 d; C 250 d 4-matic; C 400 4-matic	ott-15	apr-23	7	AB6084AT	-	MB 236.21
MERCEDES-BENZ	CLASSE C Coupé (C205)	AMG C 43 4-matic; C 180; C 200; C 200 4-matic; C 200 d; C 200 EQ Boost; C 200 EQ Boost 4-matic; C 220 d; C 220 d 4-matic; C 250; C 250 d; C 250 d 4-matic; C 300; C 300 d; C 300 d 4-matic; C 300 EQ Boost; C 300 EQ Boost 4-matic; C 400 4-matic	ott-15	apr-23	9	AB6088AT	-	MB 236.16

Marca / Brand:	Modello / Model:	Versioni / Version:	Da anno / From:	Ad anno / To:	Marce / Gears:	Codice AB PARTS		Lubrificante Consigliato
MERCEDES-BENZ	CLASSE C Coupé (C205)	AMG C 63; AMG C 63 S	feb-16	apr-23	9	AB6086AT	-	MB 236.16
MERCEDES-BENZ	CLASSE C Sportcoupe (CL203)	C 160 Kompressor; C 180; C 180 Kompressor; C 200 CDI; C 200 CGI Kompressor; C 200 Kompressor; C 220; C 220 CDI; C 230; C 230 Kompressor; C 30 CDI AMG; C 32 AMG Kompressor; C 320; C 350	mar-01	mag-08	5	AB6078AT	-	MB 236.14
MERCEDES-BENZ	CLASSE C Sportcoupe (CL203)	C 160 Kompressor; C 180; C 180 Kompressor; C 200 CDI; C 200 CGI Kompressor; C 200 Kompressor; C 220; C 220 CDI; C 230; C 230 Kompressor; C 30 CDI AMG; C 32 AMG Kompressor; C 320; C 350	mar-01	mag-08	7	AB6177AT	-	MB 236.15
MERCEDES-BENZ	CLASSE C Sportcoupe (CL203)	C 230; C 350	gen-05	mag-08	7	AB6082AT	-	MB 236.21
MERCEDES-BENZ	CLASSE C Sportcoupe (CL203)	C 230; C 350	gen-05	mag-08	7	AB6083AT	-	MB 236.21
MERCEDES-BENZ	CLASSE C Sportcoupe (CL203)	C 230; C 350	gen-05	mag-08	7	AB6084AT	-	MB 236.21
MERCEDES-BENZ	CLASSE C T-Model (S202)	C 180 T; C 200 T; C 200 T CDI; C 200 T D; C 200 T Kompressor; C 220 T CDI; C 220 T D; C 230 T; C 230 T Kompressor; C 240 T; C 250 T Turbo-D; C 280 T; C 43 AMG	giu-96	mar-01	5	AB6078AT	-	MB 236.14
MERCEDES-BENZ	CLASSE C T-Model (S202)	C 180 T; C 200 T; C 220 T D; C 230 T; C 250 T Turbo-D	giu-96	mar-01	4	AB6076AT	-	MB A0009899203
MERCEDES-BENZ	CLASSE C T-Model (S202)	C 240 T	set-00	mar-01	7	AB6177AT	-	MB 236.15
MERCEDES-BENZ	CLASSE C T-Model (S203)	C 180; C 180 Kompressor; C 200 CDI; C 200 CGI Kompressor; C 200 Kompressor; C 220 CDI; C 230; C 230 Kompressor; C 240; C 240 4-matic; C 270 CDI; C 280; C 280 4-matic; C 30 CDI AMG; C 32 AMG Kompressor; C 320; C 320 4-matic; C 320 CDI; C 350; C 350 4-matic; C 55 AMG	mar-01	ago-07	5	AB6078AT	-	MB 236.14
MERCEDES-BENZ	CLASSE C T-Model (S203)	C 180; C 180 Kompressor; C 200 CDI; C 200 CGI Kompressor; C 200 Kompressor; C 220 CDI; C 230; C 230 Kompressor; C 240; C 240 4-matic; C 270 CDI; C 280; C 280 4-matic; C 30 CDI AMG; C 32 AMG Kompressor; C 320; C 320 4-matic; C 320 CDI; C 350; C 350 4-matic; C 55 AMG	mar-01	ago-07	7	AB6177AT	-	MB 236.15
MERCEDES-BENZ	CLASSE C T-Model (S203)	C 230; C 280; C 280 4-matic; C 320 CDI; C 350; C 350 4-matic	gen-05	ago-07	7	AB6082AT	-	MB 236.21
MERCEDES-BENZ	CLASSE C T-Model (S203)	C 230; C 280; C 320 CDI; C 350	gen-05	ago-07	7	AB6083AT	-	MB 236.21
MERCEDES-BENZ	CLASSE C T-Model (S203)	C 230; C 280; C 320 CDI; C 350	gen-05	ago-07	7	AB6084AT	-	MB 236.21
MERCEDES-BENZ	CLASSE C T-Model (S204)	C 180; C 180 CDI; C 180 CGI; C 180 Kompressor; C 200 CDI; C 200 CGI; C 200 Kompressor; C 220 CDI; C 220 CDI 4-matic; C 230; C 250; C 250 CDI; C 250 CDI 4-matic; C 250 CGI; C 280; C 300; C 300 CDI 4-matic; C 320 CDI; C 320 CDI 4-matic; C 350; C 350 CDI; C 350 CDI 4-matic; C 350 CGI; C 63 AMG	ago-07	ago-14	5	AB6078AT	-	MB 236.14
MERCEDES-BENZ	CLASSE C T-Model (S204)	C 180; C 180 CDI; C 180 CGI; C 180 Kompressor; C 200 CDI; C 200 CGI; C 200 Kompressor; C 220 CDI; C 220 CDI 4-matic; C 230; C 250; C 250 CDI; C 250 CDI 4-matic; C 250 CGI; C 280; C 300; C 300 CDI 4-matic; C 320 CDI; C 320 CDI 4-matic; C 350; C 350 CDI; C 350 CDI 4-matic; C 350 CGI; C 63 AMG	ago-07	ago-14	7	AB6083AT	-	MB 236.21
MERCEDES-BENZ	CLASSE C T-Model (S204)	C 180; C 180 CDI; C 180 CGI; C 180 Kompressor; C 200 CDI; C 200 CGI; C 200 Kompressor; C 220 CDI; C 220 CDI 4-matic; C 230; C 250; C 250 CDI; C 250 CDI 4-matic; C 250 CGI; C 280; C 300; C 300 CDI 4-matic; C 320 CDI; C 320 CDI 4-matic; C 350; C 350 CDI; C 350 CDI 4-matic; C 350 CGI; C 63 AMG	ago-07	ago-14	7	AB6084AT	-	MB 236.21
MERCEDES-BENZ	CLASSE C T-Model (S204)	C 180; C 180 CDI; C 180 CGI; C 180 Kompressor; C 200 CDI; C 200 CGI; C 200 Kompressor; C 220 CDI; C 220 CDI 4-matic; C 230; C 250; C 250 CDI; C 250 CDI 4-matic; C 250 CGI; C 280; C 300; C 300 CDI 4-matic; C 320 CDI; C 320 CDI 4-matic; C 350; C 350 CDI; C 350 CDI 4-matic; C 350 CGI; C 63 AMG	ago-07	ago-14	7	AB6177AT	-	MB 236.15
MERCEDES-BENZ	CLASSE C T-Model (S204)	C 180; C 180 CDI; C 180 CGI; C 200 CDI; C 200 CGI; C 200 Kompressor; C 220 CDI; C 220 CDI 4-matic; C 250 CDI; C 250 CDI 4-matic; C 250 CGI; C 280; C 300; C 300 CDI 4-matic; C 320 CDI; C 350; C 350 CDI; C 350 CDI 4-matic; C 350 CGI; C 63 AMG	ago-07	ago-14	7	AB6082AT	-	MB 236.21

Marca / Brand:	Modello / Model:	Versioni / Version:	Da anno / From:	Ad anno / To:	Marce / Gears:	Codice AB PARTS		Lubrificante Consigliato
MERCEDES-BENZ	CLASSE C T-Model (S205)	AMG C 63 S	ott-15	feb-21	9	AB6086AT	-	MB 236.16
MERCEDES-BENZ	CLASSE C T-Model (S205)	C 180 BlueTEC; C 200 BlueTEC; C 220 BlueTEC; C 250 BlueTEC; C 250 BlueTEC 4x4; AMG C 43 4-matic; AMG C 63; AMG C 63 S; C 160; C 180; C 200; C 200 4-matic; C 200 d; C 220 d 4-matic; C 250; C 300; C 350 e; C 400 4-matic; C 450 AMG 4-matic	set-14	feb-21	7	AB6083AT	-	MB 236.21
MERCEDES-BENZ	CLASSE C T-Model (S205)	C 180 BlueTEC; C 200 BlueTEC; C 220 BlueTEC; C 250 BlueTEC; C 300 BlueTEC Hybrid; C 250 BlueTEC 4x4; AMG C 43 4-matic; AMG C 63; AMG C 63 S; C 160; C 180; C 180 d; C 200; C 200 4-matic; C 200 d; C 200 EQ Boost; C 200 EQ Boost 4-matic; C 220 d; C 220 d 4-matic; C 250; C 300; C 300 4-matic; C 300 d; C 300 d 4-matic; C 300 de; C 300 e; C 300 EQ Boost; C 300 EQ Boost 4-matic; C 350 e; C 400 4-matic; C 450 AMG 4-matic	set-14	feb-21	7	AB6177AT	-	MB 236.15
MERCEDES-BENZ	CLASSE C T-Model (S205)	C 220 BlueTEC; C 250 BlueTEC; C 250 BlueTEC 4x4; AMG C 43 4-matic; AMG C 63; AMG C 63 S; C 160; C 180; C 200; C 200 4-matic; C 200 d; C 220 d 4-matic; C 250; C 300; C 350 e; C 400 4-matic; C 450 AMG 4-matic	set-14	feb-21	7	AB6082AT	-	MB 236.21
MERCEDES-BENZ	CLASSE C T-Model (S205)	C 220 BlueTEC; C 250 BlueTEC; C 250 BlueTEC 4x4; AMG C 43 4-matic; AMG C 63; AMG C 63 S; C 160; C 180; C 200; C 200 d; C 220 d 4-matic; C 250; C 350 e; C 400 4-matic; C 450 AMG 4-matic	set-14	feb-21	7	AB6084AT	-	MB 236.21
MERCEDES-BENZ	CLASSE C T-Model (S205)	C 220 BlueTEC; C 250 BlueTEC; C 300 BlueTEC Hybrid; C 250 BlueTEC 4x4; AMG C 43 4-matic; C 160; C 180; C 180 d; C 200; C 200 4-matic; C 200 d; C 200 EQ Boost; C 200 EQ Boost 4-matic; C 220 d; C 220 d 4-matic; C 250; C 300; C 300 4-matic; C 300 d; C 300 d 4-matic; C 300 EQ Boost; C 300 EQ Boost 4-matic; C 400 4-matic; C 450 AMG 4-matic	set-14	feb-21	9	AB6088AT	-	MB 236.16
MERCEDES-BENZ	CLASSE C T-Model (S205)	C 300 BlueTEC Hybrid; C 350 e	ott-14	mag-18	7	AB6085AT	-	MB236.15
MERCEDES-BENZ	CLASSE C T-Model (S205)	C 300 de; C 300 e	mag-19	feb-21	9	AB6087AT	-	MB 236.16
MERCEDES-BENZ	CLASSE C T-MODEL (S206)	AMG C 43 4-matic+; AMG C 63 S E Performance 4-matic+; C 180; C 200; C 200 4-matic; C 200 d; C 220 d; C 220 d 4-matic; C 300; C 300 4-matic; C 300 d	mar-21	In produzione	9	AB6086AT	-	MB 236.16
MERCEDES-BENZ	CLASSE CLC (CL203)	CLC 160; CLC 180 Kompressor; CLC 200 CDI; CLC 200 Kompressor; CLC 220 CDI; CLC 230; CLC 250; CLC 350	mag-08	giu-11	5	AB6078AT	-	MB 236.14
MERCEDES-BENZ	CLASSE CLC (CL203)	CLC 160; CLC 180 Kompressor; CLC 200 CDI; CLC 200 Kompressor; CLC 220 CDI; CLC 230; CLC 250; CLC 350	mag-08	giu-11	7	AB6177AT	-	MB 236.15
MERCEDES-BENZ	CLASSE CLC (CL203)	CLC 230; CLC 250; CLC 350	mag-08	giu-11	7	AB6082AT	-	MB 236.21
MERCEDES-BENZ	CLASSE CLC (CL203)	CLC 230; CLC 250; CLC 350	mag-08	giu-11	7	AB6083AT	-	MB 236.21
MERCEDES-BENZ	CLASSE CLC (CL203)	CLC 230; CLC 250; CLC 350	mag-08	giu-11	7	AB6084AT	-	MB 236.21
MERCEDES-BENZ	CLASSE E (W124)	E 200; E 200 D; E 220; E 250 D; E 250 Turbo-D; E 280; E 300 4-matic; E 300 D; E 300 Turbo-D; E 300 Turbo-D 4-matic; E 320; E 420; E 500; E 60 AMG	giu-93	giu-95	4	AB6076AT	-	MB A0009899203
MERCEDES-BENZ	CLASSE E (W124)	E 200; E 200 D; E 220; E 250 D; E 250 Turbo-D; E 280; E 300 4-matic; E 300 D; E 300 Turbo-D; E 300 Turbo-D 4-matic; E 320; E 420; E 500; E 60 AMG	giu-93	giu-95	4	AB6077AT	-	DEXRON III
MERCEDES-BENZ	CLASSE E (W124)	E 200; E 200 D; E 220; E 250 D; E 250 Turbo-D; E 280; E 300 4-matic; E 300 D; E 300 Turbo-D; E 300 Turbo-D 4-matic; E 320; E 420; E 500; E 60 AMG	giu-93	giu-95	7	AB6177AT	-	MB 236.15
MERCEDES-BENZ	CLASSE E (W124)	E 200; E 220; E 320	giu-93	giu-95	5	AB6078AT	-	MB 236.14
MERCEDES-BENZ	CLASSE E (W210)	E 200; E 200 CDI; E 200 D; E 200 Kompressor; E 220 CDI; E 220 D; E 230; E 240; E 250 D; E 250 Turbo-D; E 270 CDI; E 280; E 280 4-matic; E 290 Turbo-D; E 300 D; E 300 Turbo-D; E 320; E 320 4-matic; E 320 CDI; E 36 AMG; E 420; E 430; E 430 4-matic; E 50 AMG; E 55 AMG	giu-95	mar-02	5	AB6078AT	-	MB 236.14

Marca / Brand:	Modello / Model:	Versioni / Version:	Da anno / From:	Ad anno / To:	Marce / Gears:	Codice AB PARTS		Lubrificante Consigliato
MERCEDES-BENZ	CLASSE E (W210)	E 200; E 200 CDI; E 200 D; E 200 Kompressor; E 220 CDI; E 220 D; E 230; E 240; E 250 D; E 250 Turbo-D; E 270 CDI; E 280; E 280 4-matic; E 290 Turbo-D; E 300 D; E 300 Turbo-D; E 320; E 320 4-matic; E 320 CDI; E 36 AMG; E 420; E 430; E 430 4-matic; E 50 AMG; E 55 AMG	giu-95	mar-02	7	AB6177AT	-	MB 236.15
MERCEDES-BENZ	CLASSE E (W210)	E 36 AMG	apr-96	gen-98	4	AB6077AT	-	DEXRON III
MERCEDES-BENZ	CLASSE E (W211)	E 200 CDI; E 200 Kompressor; E 200 NGT; E 220 CDI; E 230; E 240; E 240 4-matic; E 270 CDI; E 280; E 280 4-matic; E 280 CDI; E 280 CDI 4-matic; E 300 BlueTEC; E 320; E 320 4-matic; E 320 CDI; E 320 CDI 4-matic; E 350; E 350 4-matic; E 350 CGI; E 400 CDI; E 420 CDI; E 500; E 500 4-matic; E 55 AMG Kompressor; E 63 AMG	mar-02	dic-08	5	AB6078AT	-	MB 236.14
MERCEDES-BENZ	CLASSE E (W211)	E 200 CDI; E 200 Kompressor; E 200 NGT; E 220 CDI; E 230; E 240; E 240 4-matic; E 270 CDI; E 280; E 280 4-matic; E 280 CDI; E 280 CDI 4-matic; E 300 BlueTEC; E 320; E 320 4-matic; E 320 CDI; E 320 CDI 4-matic; E 350; E 350 4-matic; E 350 CGI; E 400 CDI; E 420 CDI; E 500; E 500 4-matic; E 55 AMG Kompressor; E 63 AMG	mar-02	dic-08	7	AB6177AT	-	MB 236.15
MERCEDES-BENZ	CLASSE E (W211)	E 230; E 280; E 280 CDI; E 300 BlueTEC; E 320 CDI; E 350; E 350 CGI; E 420 CDI; E 500; E 63 AMG	mar-02	dic-08	7	AB6083AT	-	MB 236.21
MERCEDES-BENZ	CLASSE E (W211)	E 230; E 280; E 280 CDI; E 300 BlueTEC; E 320 CDI; E 350; E 350 CGI; E 420 CDI; E 500; E 63 AMG	mar-02	dic-08	7	AB6084AT	-	MB 236.21
MERCEDES-BENZ	CLASSE E (W211)	E 350 CGI	set-07	dic-08	7	AB6082AT	-	MB 236.21
MERCEDES-BENZ	CLASSE E (W212)	E 200 CDI; E 220 CDI; E 250 CDI; E 300 CDI; E 220 BlueTEC; E 350 BlueTEC; E 350 BlueTEC 4-matic; E 350 CDI; E 350 CDI 4-matic; E 500; E 500 4-matic	gen-09	dic-16	9	AB6088AT	-	MB 236.16
MERCEDES-BENZ	CLASSE E (W212)	E 200 CDI; E 220 CDI; E 250 CDI; E 300 CDI; E 250 CDI 4x4; E 180; E 200; E 200 CGI; E 200 NGT; E 220 BlueTEC; E 220 BlueTEC 4-matic; E 250; E 250 CGI; E 300; E 300 4-matic; E 350; E 350 4-matic; E 350 BlueTEC; E 350 BlueTEC 4-matic; E 350 CDI; E 350 CDI 4-matic; E 400; E 400 4-matic; E 500; E 500 4-matic; E 63 AMG; E 63 AMG 4-matic	gen-09	dic-16	7	AB6082AT	-	MB 236.21
MERCEDES-BENZ	CLASSE E (W212)	E 200 CDI; E 220 CDI; E 250 CDI; E 300 CDI; E 250 CDI 4x4; E 180; E 200; E 200 CGI; E 200 NGT; E 220 BlueTEC; E 220 BlueTEC 4-matic; E 250; E 250 CGI; E 300; E 300 4-matic; E 350; E 350 4-matic; E 350 BlueTEC; E 350 BlueTEC 4-matic; E 350 CDI; E 350 CDI 4-matic; E 400; E 400 4-matic; E 500; E 500 4-matic; E 63 AMG; E 63 AMG 4-matic	gen-09	dic-16	7	AB6084AT	-	MB 236.21
MERCEDES-BENZ	CLASSE E (W212)	E 200 CDI; E 220 CDI; E 250 CDI; E 300 CDI; E 300 Hybrid; E 250 CDI 4x4; E 180; E 200; E 200 CGI; E 200 NGT; E 220 BlueTEC; E 220 BlueTEC 4-matic; E 250; E 250 CGI; E 300; E 300 4-matic; E 350; E 350 4-matic; E 350 BlueTEC; E 350 BlueTEC 4-matic; E 350 CDI; E 350 CDI 4-matic; E 400; E 400 4-matic; E 500; E 500 4-matic; E 63 AMG; E 63 AMG 4-matic	gen-09	dic-16	5	AB6078AT	-	MB 236.14
MERCEDES-BENZ	CLASSE E (W212)	E 200 CDI; E 220 CDI; E 250 CDI; E 300 CDI; E 300 Hybrid; E 250 CDI 4x4; E 180; E 200; E 200 CGI; E 200 NGT; E 220 BlueTEC; E 220 BlueTEC 4-matic; E 250; E 250 CGI; E 300; E 300 4-matic; E 350; E 350 4-matic; E 350 BlueTEC; E 350 BlueTEC 4-matic; E 350 CDI; E 350 CDI 4-matic; E 400; E 400 4-matic; E 500; E 500 4-matic; E 63 AMG; E 63 AMG 4-matic	gen-09	dic-16	7	AB6083AT	-	MB 236.21
MERCEDES-BENZ	CLASSE E (W212)	E 200 CDI; E 220 CDI; E 250 CDI; E 300 CDI; E 300 Hybrid; E 250 CDI 4x4; E 180; E 200; E 200 CGI; E 200 NGT; E 220 BlueTEC; E 220 BlueTEC 4-matic; E 250; E 250 CGI; E 300; E 300 4-matic; E 350; E 350 4-matic; E 350 BlueTEC; E 350 BlueTEC 4-matic; E 350 CDI; E 350 CDI 4-matic; E 400; E 400 4-matic; E 500; E 500 4-matic; E 63 AMG; E 63 AMG 4-matic	gen-09	dic-16	7	AB6177AT	-	MB 236.15
MERCEDES-BENZ	CLASSE E (W212)	E 300 Hybrid	dic-11	dic-16	7	AB6085AT	-	MB236.15
MERCEDES-BENZ	CLASSE E (W212)	E 500	set-11	dic-15	9	AB6087AT	-	MB 236.16

Marca / Brand:	Modello / Model:	Versioni / Version:	Da anno / From:	Ad anno / To:	Marce / Gears:	Codice AB PARTS		Lubrificante Consigliato
MERCEDES-BENZ	CLASSE E (W213)	AMG E 43 4-matic; AMG E 53 EQ Boost 4-matic+; E 180; E 200; E 200 4-matic; E 200 d; E 200 EQ Boost; E 200 EQ Boost 4-matic; E 220 d; E 220 d 4-matic; E 250; E 300; E 300 d; E 300 EQ Boost; E 350 d; E 350 d 4-matic; E 350 EQ Boost; E 400 4-matic; E 400 d; E 400 d 4-matic; E 450 4-matic; E 450 EQ Boost 4-matic	gen-16	ott-23	9	AB6088AT	-	MB 236.16
MERCEDES-BENZ	CLASSE E (W213)	AMG E 63 4-matic+; AMG E 63 S 4-matic+; E 220 d; E 220 d 4-matic; E 300 d; E 300 d 4-matic	gen-16	ott-23	9	AB6086AT	-	MB 236.16
MERCEDES-BENZ	CLASSE E (W213)	E 300 de; E 300 de 4-matic; E 300 e; E 300 e 4-matic; E 350 e	lug-16	ott-23	9	AB6087AT	-	MB 236.16
MERCEDES-BENZ	CLASSE E (W214)	E 200; E 220 d; E 220 d 4-matic	lug-23	In produzione	9	AB6086AT	-	MB 236.16
MERCEDES-BENZ	CLASSE E All-Terrain (S213)	E 220 d 4-matic	gen-17	ott-23	9	AB6086AT	-	MB 236.16
MERCEDES-BENZ	CLASSE E All-Terrain (S213)	E 220 d 4-matic; E 350 d 4-matic; E 400 d 4-matic	gen-17	ott-23	9	AB6088AT	-	MB 236.16
MERCEDES-BENZ	CLASSE E Cabriolet (A124)	E 200; E 220; E 320; E 36 AMG	giu-93	mar-98	5	AB6078AT	-	MB 236.14
MERCEDES-BENZ	CLASSE E Cabriolet (A124)	E 200; E 220; E 320; E 36 AMG	giu-93	mar-98	4	AB6076AT	-	MB A0009899203
MERCEDES-BENZ	CLASSE E Cabriolet (A124)	E 200; E 220; E 320; E 36 AMG	giu-93	mar-98	4	AB6077AT	-	DEXRON III
MERCEDES-BENZ	CLASSE E Cabriolet (A124)	E 200; E 220; E 320; E 36 AMG	giu-93	mar-98	7	AB6177AT	-	MB 236.15
MERCEDES-BENZ	CLASSE E Cabriolet (A207)	E 350 BlueTEC; E 220 CDI; E 250 CDI; E 200; E 200 CGI; E 220 BlueTEC; E 250; E 250 CGI; E 300; E 320; E 350; E 350 CDI; E 350 CGI; E 400; E 500	gen-10	dic-16	5	AB6078AT	-	MB 236.14
MERCEDES-BENZ	CLASSE E Cabriolet (A207)	E 350 BlueTEC; E 220 CDI; E 250 CDI; E 200; E 200 CGI; E 220 BlueTEC; E 250; E 250 CGI; E 300; E 320; E 350; E 350 CDI; E 350 CGI; E 400; E 500	gen-10	dic-16	7	AB6083AT	-	MB 236.21
MERCEDES-BENZ	CLASSE E Cabriolet (A207)	E 350 BlueTEC; E 220 CDI; E 250 CDI; E 200; E 200 CGI; E 220 BlueTEC; E 250; E 250 CGI; E 300; E 320; E 350; E 350 CDI; E 350 CGI; E 400; E 500	gen-10	dic-16	7	AB6084AT	-	MB 236.21
MERCEDES-BENZ	CLASSE E Cabriolet (A207)	E 350 BlueTEC; E 220 CDI; E 250 CDI; E 200; E 200 CGI; E 220 BlueTEC; E 250; E 250 CGI; E 300; E 320; E 350; E 350 CDI; E 350 CGI; E 400; E 500	gen-10	dic-16	7	AB6177AT	-	MB 236.15
MERCEDES-BENZ	CLASSE E Cabriolet (A207)	E 350 BlueTEC; E 220 CDI; E 250 CDI; E 200; E 200 CGI; E 220 BlueTEC; E 250; E 250 CGI; E 300; E 320; E 350; E 400; E 500	gen-10	dic-16	7	AB6082AT	-	MB 236.21
MERCEDES-BENZ	CLASSE E Cabriolet (A207)	E 350 BlueTEC; E 220 CDI; E 250 CDI; E 220 BlueTEC; E 350 CDI	gen-10	dic-16	9	AB6088AT	-	MB 236.16
MERCEDES-BENZ	CLASSE E Cabriolet (A238)	AMG E53 EQ Boost 4-matic+; E 200; E 200 4-matic; E 200 EQ Boost; E 200 EQ Boost 4-matic; E 220 d; E 220 d 4-matic; E 300; E 300 d; E 300 EQ Boost; E 350 d; E 350 d 4-matic; E 350 EQ Boost; E 400 4-matic; E 400 d 4-matic; E 450 4-matic; E 450 EQ Boost 4-matic	giu-17	In produzione	9	AB6088AT	-	MB 236.16
MERCEDES-BENZ	CLASSE E Cabriolet (A238)	E 300 d 4-matic	apr-21	In produzione	9	AB6086AT	-	MB 236.16
MERCEDES-BENZ	CLASSE E Coupé (C124)	E 200; E 220; E 320; E 36 AMG	giu-93	giu-97	5	AB6078AT	-	MB 236.14
MERCEDES-BENZ	CLASSE E Coupé (C124)	E 200; E 220; E 320; E 36 AMG	giu-93	giu-97	4	AB6076AT	-	MB A0009899203
MERCEDES-BENZ	CLASSE E Coupé (C124)	E 200; E 220; E 320; E 36 AMG	giu-93	giu-97	4	AB6077AT	-	DEXRON III
MERCEDES-BENZ	CLASSE E Coupé (C124)	E 200; E 220; E 320; E 36 AMG	giu-93	giu-97	7	AB6177AT	-	MB 236.15
MERCEDES-BENZ	CLASSE E Coupé (C207)	E 220 CDI; E 350 BlueTEC; E 250 CDI; E 200; E 200 CGI; E 220 BlueTEC; E 250; E 250 CGI; E 300; E 320; E 350; E 350 4-matic; E 350 CDI; E 350 CGI; E 400; E 500	gen-09	dic-16	5	AB6078AT	-	MB 236.14
MERCEDES-BENZ	CLASSE E Coupé (C207)	E 220 CDI; E 350 BlueTEC; E 250 CDI; E 200; E 200 CGI; E 220 BlueTEC; E 250; E 250 CGI; E 300; E 320; E 350; E 350 4-matic; E 350 CDI; E 350 CGI; E 400; E 500	gen-09	dic-16	7	AB6083AT	-	MB 236.21
MERCEDES-BENZ	CLASSE E Coupé (C207)	E 220 CDI; E 350 BlueTEC; E 250 CDI; E 200; E 200 CGI; E 220 BlueTEC; E 250; E 250 CGI; E 300; E 320; E 350; E 350 4-matic; E 350 CDI; E 350 CGI; E 400; E 500	gen-09	dic-16	7	AB6084AT	-	MB 236.21
MERCEDES-BENZ	CLASSE E Coupé (C207)	E 220 CDI; E 350 BlueTEC; E 250 CDI; E 200; E 200 CGI; E 220 BlueTEC; E 250; E 250 CGI; E 300; E 320; E 350; E 350 4-matic; E 350 CDI; E 350 CGI; E 400; E 500	gen-09	dic-16	7	AB6177AT	-	MB 236.15

Marca / Brand:	Modello / Model:	Versioni / Version:	Da anno / From:	Ad anno / To:	Marce / Gears:	Codice AB PARTS		Lubrificante Consigliato
MERCEDES-BENZ	CLASSE E Coupé (C207)	E 220 CDI; E 350 BlueTEC; E 250 CDI; E 200; E 200 CGI; E 220 BlueTEC; E 250; E 250 CGI; E 300; E 320; E 350; E 350 4-matic; E 400; E 500	gen-09	dic-16	7	AB6082AT	-	MB 236.21
MERCEDES-BENZ	CLASSE E Coupé (C207)	E 220 CDI; E 350 BlueTEC; E 250 CDI; E 220 BlueTEC; E 350 CDI	gen-09	dic-16	9	AB6088AT	-	MB 236.16
MERCEDES-BENZ	CLASSE E Coupé (C238)	AMG E 53 EQ Boost 4-matic+; E 200; E 200 4-matic; E 200 EQ Boost; E 200 EQ Boost 4-matic; E 220 d; E 220 d 4-matic; E 300; E 300 d; E 300 EQ Boost; E 350 d; E 350 d 4-matic; E 350 EQ Boost; E 400 4-matic; E 400 d 4-matic; E 450 4-matic; E 450 EQ Boost 4-matic	dic-16	In produzione	9	AB6088AT	-	MB 236.16
MERCEDES-BENZ	CLASSE E Coupé (C238)	E 300 d 4-matic	gen-21	In produzione	9	AB6086AT	-	MB 236.16
MERCEDES-BENZ	CLASSE E Pianale piatto/Telaio (VF210)	E 220 CDI; E 250 d; E 270 CDI; E 280; E 290 TD	giu-96	dic-02	5	AB6078AT	-	MB 236.14
MERCEDES-BENZ	CLASSE E Pianale piatto/Telaio (VF210)	E 220 CDI; E 250 d; E 270 CDI; E 280; E 290 TD	giu-96	dic-02	7	AB6177AT	-	MB 236.15
MERCEDES-BENZ	CLASSE E Pianale piatto/Telaio (VF211)	E 220 CDI; E 270 CDI; E 280 CDI	mar-03	lug-09	5	AB6078AT	-	MB 236.14
MERCEDES-BENZ	CLASSE E Pianale piatto/Telaio (VF211)	E 220 CDI; E 270 CDI; E 280 CDI	mar-03	lug-09	7	AB6177AT	-	MB 236.15
MERCEDES-BENZ	CLASSE E Pianale piatto/Telaio (VF211)	E 280 CDI	ago-05	lug-09	7	AB6083AT	-	MB 236.21
MERCEDES-BENZ	CLASSE E Pianale piatto/Telaio (VF211)	E 280 CDI	ago-05	lug-09	7	AB6084AT	-	MB 236.21
MERCEDES-BENZ	CLASSE E T-Model (S124)	E 200 T; E 220 T; E 250 TD; E 250 Turbo D; E 280 T; E 300 T 4-matic; E 300 T Turbo-D; E 300 T Turbo-D 4-matic; E 300 TD; E 320 T; E 36 T AMG	giu-93	giu-96	4	AB6076AT	-	MB A000989203
MERCEDES-BENZ	CLASSE E T-Model (S124)	E 200 T; E 220 T; E 250 TD; E 250 Turbo D; E 280 T; E 300 T 4-matic; E 300 T Turbo-D; E 300 T Turbo-D 4-matic; E 300 TD; E 320 T; E 36 T AMG	giu-93	giu-96	4	AB6077AT	-	DEXRON III
MERCEDES-BENZ	CLASSE E T-Model (S124)	E 200 T; E 220 T; E 250 TD; E 250 Turbo D; E 280 T; E 300 T 4-matic; E 300 T Turbo-D; E 300 T Turbo-D 4-matic; E 300 TD; E 320 T; E 36 T AMG	giu-93	giu-96	7	AB6177AT	-	MB 236.15
MERCEDES-BENZ	CLASSE E T-Model (S124)	E 200 T; E 220 T; E 320 T	giu-93	giu-96	5	AB6078AT	-	MB 236.14
MERCEDES-BENZ	CLASSE E T-Model (S210)	E 200 T; E 200 T Kompressor; E 220 T CDI; E 230 T; E 240 T; E 250 T D; E 250 T Turbo-D; E 270 T CDI; E 280 T; E 280 T 4-matic; E 290 T Turbo-D; E 300 T Turbo-D; E 320 T; E 320 T 4-matic; E 320 T CDI; E 420 T; E 430 T; E 430 T 4-matic; E 55 T AMG	giu-96	mar-03	5	AB6078AT	-	MB 236.14
MERCEDES-BENZ	CLASSE E T-Model (S210)	E 200 T; E 200 T Kompressor; E 220 T CDI; E 230 T; E 240 T; E 250 T D; E 250 T Turbo-D; E 270 T CDI; E 280 T; E 280 T 4-matic; E 290 T Turbo-D; E 300 T Turbo-D; E 320 T; E 320 T 4-matic; E 320 T CDI; E 420 T; E 430 T; E 430 T 4-matic; E 55 T AMG	giu-96	mar-03	7	AB6177AT	-	MB 236.15
MERCEDES-BENZ	CLASSE E T-Model (S211)	350 CGI; E 200 CDI; E 200 Kompressor; E 200 T Kompressor; E 220 CDI; E 220 T CDI; E 230 T; E 240 T; E 240 T 4-matic; E 270 T CDI; E 280 T; E 280 T 4-matic; E 280 T CDI; E 280 T CDI 4-matic; E 320 T; E 320 T 4-matic; E 320 T CDI; E 320 T CDI 4-matic; E 350 T; E 350 T 4-matic; E 500 T; E 500 T 4-matic; E 55 T AMG Kompressor; E 63 AMG	mar-03	lug-09	5	AB6078AT	-	MB 236.14
MERCEDES-BENZ	CLASSE E T-Model (S211)	350 CGI; E 200 CDI; E 200 Kompressor; E 200 T Kompressor; E 220 CDI; E 220 T CDI; E 230 T; E 240 T; E 240 T 4-matic; E 270 T CDI; E 280 T; E 280 T 4-matic; E 280 T CDI; E 280 T CDI 4-matic; E 320 T; E 320 T 4-matic; E 320 T CDI; E 320 T CDI 4-matic; E 350 T; E 350 T 4-matic; E 500 T; E 500 T 4-matic; E 55 T AMG Kompressor; E 63 AMG	mar-03	lug-09	7	AB6177AT	-	MB 236.15
MERCEDES-BENZ	CLASSE E T-Model (S211)	350 CGI; E 230 T; E 280 T; E 280 T CDI; E 320 T CDI; E 350 T; E 500 T; E 63 AMG	ott-03	lug-09	7	AB6083AT	-	MB 236.21
MERCEDES-BENZ	CLASSE E T-Model (S211)	350 CGI; E 230 T; E 280 T; E 280 T CDI; E 320 T CDI; E 350 T; E 500 T; E 63 AMG	ott-03	lug-09	7	AB6084AT	-	MB 236.21
MERCEDES-BENZ	CLASSE E T-Model (S212)	E 200 CDI; E 220 CDI; E 250 CDI; E 300 CDI; E 250 CDI 4x4; E 200; E 200 CGI; E 220 BlueTEC; E 220 BlueTEC 4-matic; E 250; E 250 CGI; E 300; E 300 4-matic; E 350; E 350 4-matic; E 350 BlueTEC; E 350 BlueTEC 4-matic; E 350 CDI; E 350 CDI 4-matic; E 350 CGI; E 400; E 400 4-matic; E 500; E 500 4-matic; E 63 AMG; E 63 AMG 4-matic	ago-09	dic-16	7	AB6083AT	-	MB 236.21

Marca / Brand:	Modello / Model:	Versioni / Version:	Da anno / From:	Ad anno / To:	Marce / Gears:	Codice AB PARTS		Lubrificante Consigliato
MERCEDES-BENZ	CLASSE E T-Model (S212)	E 200 CDI; E 220 CDI; E 250 CDI; E 300 CDI; E 250 CDI 4x4; E 200; E 200 CGI; E 220 BlueTEC; E 220 BlueTEC 4-matic; E 250; E 250 CGI; E 300; E 300 4-matic; E 350; E 350 4-matic; E 350 BlueTEC; E 350 BlueTEC 4-matic; E 350 CDI; E 350 CDI 4-matic; E 350 CGI; E 400; E 400 4-matic; E 500; E 63 AMG; E 63 AMG 4-matic	ago-09	dic-16	7	AB6084AT	-	MB 236.21
MERCEDES-BENZ	CLASSE E T-Model (S212)	E 200 CDI; E 220 CDI; E 250 CDI; E 300 CDI; E 250 CDI 4x4; E 200; E 200 CGI; E 220 BlueTEC; E 220 BlueTEC 4-matic; E 250; E 300; E 300 4-matic; E 350; E 350 4-matic; E 350 BlueTEC; E 350 BlueTEC 4-matic; E 400; E 400 4-matic; E 500; E 500 4-matic; E 63 AMG; E 63 AMG 4-matic	ago-09	dic-16	7	AB6082AT	-	MB 236.21
MERCEDES-BENZ	CLASSE E T-Model (S212)	E 200 CDI; E 220 CDI; E 250 CDI; E 300 CDI; E 300 Hybrid; E 250 CDI 4x4; E 200; E 200 CGI; E 220 BlueTEC; E 220 BlueTEC 4-matic; E 250; E 250 CGI; E 300; E 300 4-matic; E 350; E 350 4-matic; E 350 BlueTEC; E 350 BlueTEC 4-matic; E 350 CDI; E 350 CDI 4-matic; E 350 CGI; E 400; E 400 4-matic; E 500; E 500 4-matic; E 63 AMG; E 63 AMG 4-matic	ago-09	dic-16	5	AB6078AT	-	MB 236.14
MERCEDES-BENZ	CLASSE E T-Model (S212)	E 200 CDI; E 220 CDI; E 250 CDI; E 300 CDI; E 300 Hybrid; E 250 CDI 4x4; E 200; E 200 CGI; E 220 BlueTEC; E 220 BlueTEC 4-matic; E 250; E 250 CGI; E 300; E 300 4-matic; E 350; E 350 4-matic; E 350 BlueTEC; E 350 BlueTEC 4-matic; E 350 CDI; E 350 CDI 4-matic; E 350 CGI; E 400; E 400 4-matic; E 500; E 500 4-matic; E 63 AMG; E 63 AMG 4-matic	ago-09	dic-16	7	AB6177AT	-	MB 236.15
MERCEDES-BENZ	CLASSE E T-Model (S212)	E 200 CDI; E 220 CDI; E 250 CDI; E 300 CDI; E 350 BlueTEC; E 350 BlueTEC 4-matic; E 350 CDI; E 350 CDI 4-matic; E 500; E 500 4-matic	ago-09	dic-16	9	AB6088AT	-	MB 236.16
MERCEDES-BENZ	CLASSE E T-Model (S212)	E 300 Hybrid	dic-11	dic-16	7	AB6085AT	-	MB236.15
MERCEDES-BENZ	CLASSE E T-Model (S212)	E 500	set-11	dic-16	9	AB6087AT	-	MB 236.16
MERCEDES-BENZ	CLASSE E T-Model (S213)	AMG E 43 4-matic; AMG E 53 EQ Boost 4-matic+; E 200; E 200 4-matic; E 200 d; E 200 EQ Boost; E 200 EQ Boost 4-matic; E 220 d; E 220 d 4-matic; E 250; E 300 d; E 300 EQ Boost; E 350 d; E 350 d 4-matic; E 400 4-matic; E 400 d; E 400 d 4-matic; E 450 4-matic; E 450 EQ Boost	lug-16	ott-23	9	AB6088AT	-	MB 236.16
MERCEDES-BENZ	CLASSE E T-Model (S213)	AMG E 63 4-matic+; AMG E 63 S 4-matic+; E 220 d; E 220 d 4-matic; E 300 d 4-matic	lug-16	ott-23	9	AB6086AT	-	MB 236.16
MERCEDES-BENZ	CLASSE E T-Model (S213)	E 300 de; E 300 de 4-matic; E 300 e	ott-18	ott-23	9	AB6087AT	-	MB 236.16
MERCEDES-BENZ	CLASSE G (W461)	290 GD; 230 GE; G 270 CDI; G 280 CDI; G 290 TD; G 300 CDI	set-89	In produzione	5	AB6078AT	-	MB 236.14
MERCEDES-BENZ	CLASSE G (W461)	290 GD; 230 GE; G 270 CDI; G 280 CDI; G 290 TD; G 300 CDI	set-89	In produzione	7	AB6177AT	-	MB 236.15
MERCEDES-BENZ	CLASSE G (W463)	200 GE; 230 GE; 250 GD; 300 GD; 300 GE; 350 Turbo GD; 500 GE; AMG G 63; AMG G 65; G 270 CDI; G 300; G 300 Diesel; G 300 TD; G 320; G 320 CDI; G 350 CDI; G 350 d; G 36 AMG; G 400 CDI; G 500; G 55 AMG; G 63 AMG; G 63 AMG 6x6; G 65 AMG	set-89	apr-18	5	AB6078AT	-	MB 236.14
MERCEDES-BENZ	CLASSE G (W463)	200 GE; 230 GE; 250 GD; 300 GD; 300 GE; 350 Turbo GD; 500 GE; AMG G 63; AMG G 65; G 270 CDI; G 300; G 300 Diesel; G 300 TD; G 320; G 320 CDI; G 350 CDI; G 350 d; G 36 AMG; G 400 CDI; G 500; G 55 AMG; G 63 AMG; G 63 AMG 6x6; G 65 AMG	set-89	apr-18	7	AB6177AT	-	MB 236.15
MERCEDES-BENZ	CLASSE G (W463)	AMG G 63; AMG G 63 4x4 ²	mar-18	In produzione	9	AB6086AT	-	MB 236.16
MERCEDES-BENZ	CLASSE G (W463)	AMG G 63; AMG G 65; G 320 CDI; G 350 CDI; G 350 d; G 500; G 63 AMG; G 63 AMG 6x6; G 65 AMG	apr-98	In produzione	7	AB6082AT	-	MB 236.21
MERCEDES-BENZ	CLASSE G (W463)	AMG G 63; AMG G 65; G 320 CDI; G 350 CDI; G 350 d; G 500; G 63 AMG; G 63 AMG 6x6; G 65 AMG	apr-98	apr-18	7	AB6083AT	-	MB 236.21
MERCEDES-BENZ	CLASSE G (W463)	AMG G 63; AMG G 65; G 320 CDI; G 350 CDI; G 350 d; G 500; G 63 AMG; G 63 AMG 6x6; G 65 AMG	apr-98	apr-18	7	AB6084AT	-	MB 236.21
MERCEDES-BENZ	CLASSE G (W463)	G 350 d 4-matic; G 400 d 4-matic; G 500	gen-18	In produzione	9	AB6088AT	-	MB 236.16
MERCEDES-BENZ	CLASSE G Cabrio (W463)	200 GE; 230 GE; 300 GD; 300 GE; 320 GE; 350 G Turbo-D; G 300 Diesel; G 300 TD; G 320; G 320 CDI; G 350 CDI; G 400 CDI; G 500	set-89	dic-15	5	AB6078AT	-	MB 236.14

Marca / Brand:	Modello / Model:	Versioni / Version:	Da anno / From:	Ad anno / To:	Marce / Gears:	Codice AB PARTS		Lubrificante Consigliato
MERCEDES-BENZ	CLASSE G Cabrio (W463)	200 GE; 230 GE; 300 GD; 300 GE; 320 GE; 350 G Turbo-D; G 300 Diesel; G 300 TD; G 320; G 320 CDI; G 350 CDI; G 400 CDI; G 500	set-89	dic-15	7	AB6177AT	-	MB 236.15
MERCEDES-BENZ	CLASSE G Cabrio (W463)	G 320 CDI; G 350 CDI; G 500	apr-98	dic-15	7	AB6082AT	-	MB 236.21
MERCEDES-BENZ	CLASSE G Cabrio (W463)	G 320 CDI; G 350 CDI; G 500	apr-98	dic-15	7	AB6083AT	-	MB 236.21
MERCEDES-BENZ	CLASSE G Cabrio (W463)	G 320 CDI; G 350 CDI; G 500	apr-98	dic-15	7	AB6084AT	-	MB 236.21
MERCEDES-BENZ	CLASSE G Pianale piatto/Telaio (W461)	290 GD 4-matic; G 280 CDI 4-matic	nov-91	dic-12	5	AB6078AT	-	MB 236.14
MERCEDES-BENZ	CLASSE G Pianale piatto/Telaio (W461)	290 GD 4-matic; G 280 CDI 4-matic	nov-91	dic-12	7	AB6177AT	-	MB 236.15
MERCEDES-BENZ	CLASSE GL (X164)	GL 320 CDI 4x4; GL 320 CDI 4-matic; GL 350 CDI 4-matic; GL 420 CDI 4-matic; GL 450 4-matic; GL 450 CDI 4-matic; GL 500 4-matic	set-06	dic-12	7	AB6083AT	-	MB 236.21
MERCEDES-BENZ	CLASSE GL (X164)	GL 320 CDI 4x4; GL 320 CDI 4-matic; GL 350 CDI 4-matic; GL 420 CDI 4-matic; GL 450 4-matic; GL 450 CDI 4-matic; GL 500 4-matic	set-06	dic-12	7	AB6084AT	-	MB 236.21
MERCEDES-BENZ	CLASSE GL (X164)	GL 320 CDI 4x4; GL 320 CDI 4-matic; GL 350 CDI 4-matic; GL 420 CDI 4-matic; GL 450 4-matic; GL 450 CDI 4-matic; GL 500 4-matic	set-06	dic-12	7	AB6177AT	-	MB 236.15
MERCEDES-BENZ	CLASSE GL (X166)	GL 350 CDI 4x4; GL 400 4-matic; GL 500 4-matic	lug-12	ott-15	9	AB6088AT	-	MB 236.16
MERCEDES-BENZ	CLASSE GL (X166)	GL 350 CDI 4x4; GL 400 4-matic; GL 500 4-matic	lug-12	ott-15	9	AB6086AT	-	MB 236.16
MERCEDES-BENZ	CLASSE GL (X166)	GL 350 CDI 4x4; GL 400 4-matic; GL 500 4-matic; GL 63 AMG 4-matic	lug-12	ott-15	7	AB6082AT	-	MB 236.21
MERCEDES-BENZ	CLASSE GL (X166)	GL 350 CDI 4x4; GL 400 4-matic; GL 500 4-matic; GL 63 AMG 4-matic	lug-12	ott-15	7	AB6083AT	-	MB 236.21
MERCEDES-BENZ	CLASSE GL (X166)	GL 350 CDI 4x4; GL 400 4-matic; GL 500 4-matic; GL 63 AMG 4-matic	lug-12	ott-15	7	AB6084AT	-	MB 236.21
MERCEDES-BENZ	CLASSE GL (X166)	GL 500 4-matic	lug-12	ott-15	9	AB6087AT	-	MB 236.16
MERCEDES-BENZ	CLASSE GLA (X156)	GLA 180 CDI; GLA 200 CDI; GLA 220 CDI; GLA 220 CDI 4x4; AMG GLA 45 4-matic; GLA 180; GLA 200; GLA 200 CDI 4-matic; GLA 220 4-matic; GLA 220 CDI 4-matic; GLA 220 d; GLA 220 d 4-matic; GLA 250; GLA 250 4-matic; GLA 250 Flex; GLA 45 AMG 4-matic	dic-13	dic-19	7	AB6080AT + AB6081AT	-	MB 236.21
MERCEDES-BENZ	CLASSE GLK (X204)	200; 200 CDI; 220 CDI; 220 CDI 4-matic; 250; 250 4-matic; 250 CDI 4-matic; 280 4-matic; 300 4-matic; 320 CDI 4-matic; 350; 350 4-matic; 350 CDI 4-matic	giu-08	dic-15	7	AB6083AT	-	MB 236.21
MERCEDES-BENZ	CLASSE GLK (X204)	200; 200 CDI; 220 CDI; 220 CDI 4-matic; 250; 250 4-matic; 250 CDI 4-matic; 280 4-matic; 300 4-matic; 320 CDI 4-matic; 350; 350 4-matic; 350 CDI 4-matic	giu-08	dic-15	7	AB6177AT	-	MB 236.15
MERCEDES-BENZ	CLASSE GLK (X204)	200; 200 CDI; 220 CDI; 220 CDI 4-matic; 250; 250 4-matic; 250 CDI 4-matic; 300 4-matic; 320 CDI 4-matic; 350; 350 4-matic; 350 CDI 4-matic	giu-08	dic-15	7	AB6082AT	-	MB 236.21
MERCEDES-BENZ	CLASSE GLK (X204)	200; 200 CDI; 220 CDI; 220 CDI 4-matic; 250; 250 CDI 4-matic; 280 4-matic; 300 4-matic; 320 CDI 4-matic; 350; 350 4-matic; 350 CDI 4-matic	giu-08	dic-15	7	AB6084AT	-	MB 236.21
MERCEDES-BENZ	CLASSE M (W163)	ML 230; ML 270 CDI; ML 320; ML 350; ML 400 CDI; ML 430; ML 500; ML 55 AMG	feb-98	giu-05	5	AB6078AT	-	MB 236.14
MERCEDES-BENZ	CLASSE M (W163)	ML 230; ML 270 CDI; ML 320; ML 350; ML 400 CDI; ML 430; ML 500; ML 55 AMG	feb-98	giu-05	7	AB6177AT	-	MB 236.15
MERCEDES-BENZ	CLASSE M (W164)	ML 280 CDI 4-matic; ML 300 CDI 4-matic; ML 320 CDI 4-matic; ML 350 4-matic; ML 350 CDI 4-matic; ML 420 CDI 4-matic; ML 450 CDI 4-matic; ML 500 4-matic; ML 63 AMG 4-matic	feb-05	dic-11	7	AB6083AT	-	MB 236.21
MERCEDES-BENZ	CLASSE M (W164)	ML 280 CDI 4-matic; ML 300 CDI 4-matic; ML 320 CDI 4-matic; ML 350 4-matic; ML 350 CDI 4-matic; ML 420 CDI 4-matic; ML 450 CDI 4-matic; ML 500 4-matic; ML 63 AMG 4-matic	feb-05	dic-11	7	AB6084AT	-	MB 236.21
MERCEDES-BENZ	CLASSE M (W164)	ML 280 CDI 4-matic; ML 300 CDI 4-matic; ML 320 CDI 4-matic; ML 350 4-matic; ML 350 CDI 4-matic; ML 420 CDI 4-matic; ML 450 CDI 4-matic; ML 500 4-matic; ML 63 AMG 4-matic	feb-05	dic-11	7	AB6177AT	-	MB 236.15
MERCEDES-BENZ	CLASSE M (W166)	ML 250 CDI 4x4; ML 300 4-matic; ML 350 4-matic; ML 350 BlueTEC 4-matic; ML 400 4-matic; ML 500 4-matic; ML 63 AMG 4-matic	giu-11	dic-15	7	AB6082AT	-	MB 236.21

Marca / Brand:	Modello / Model:	Versioni / Version:	Da anno / From:	Ad anno / To:	Marce / Gears:	Codice AB PARTS		Lubrificante Consigliato
MERCEDES-BENZ	CLASSE M (W166)	ML 250 CDI 4x4; ML 300 4-matic; ML 350 4-matic; ML 350 BlueTEC 4-matic; ML 400 4-matic; ML 500 4-matic; ML 63 AMG 4-matic	giu-11	dic-15	7	AB6083AT	-	MB 236.21
MERCEDES-BENZ	CLASSE M (W166)	ML 250 CDI 4x4; ML 300 4-matic; ML 350 4-matic; ML 350 BlueTEC 4-matic; ML 400 4-matic; ML 500 4-matic; ML 63 AMG 4-matic	giu-11	dic-15	7	AB6084AT	-	MB 236.21
MERCEDES-BENZ	CLASSE M (W166)	ML 250 CDI 4x4; ML 300 4-matic; ML 350 4-matic; ML 350 BlueTEC 4-matic; ML 400 4-matic; ML 500 4-matic; ML 63 AMG 4-matic	giu-11	dic-15	7	AB6177AT	-	MB 236.15
MERCEDES-BENZ	CLASSE M (W166)	ML 250 CDI 4x4; ML 350 4-matic; ML 350 BlueTEC 4-matic; ML 400 4-matic; ML 500 4-matic	giu-11	dic-15	9	AB6088AT	-	MB 236.16
MERCEDES-BENZ	CLASSE M (W166)	ML 250 CDI 4x4; ML 350 BlueTEC 4-matic; ML 400 4-matic; ML 500 4-matic	giu-11	dic-15	9	AB6086AT	-	MB 236.16
MERCEDES-BENZ	CLASSE R (W251, V251)	R 280; R 280 4-matic; R 280 CDI; R 280 CDI 4-matic; R 300; R 300 4-matic; R 300 CDI; R 300 CDI 4-matic; R 320 CDI 4-matic; R 350; R 350 4-matic; R 350 CDI 4-matic; R 350 CGI 4-matic; R 500 4-matic; R 63 AMG 4-matic	giu-05	dic-14	7	AB6177AT	-	MB 236.15
MERCEDES-BENZ	CLASSE R (W251, V251)	R 280; R 280 CDI; R 280 CDI 4-matic; R 300; R 300 CDI; R 300 CDI 4-matic; R 320 CDI 4-matic; R 350; R 350 4-matic; R 350 CDI 4-matic; R 350 CGI 4-matic; R 500 4-matic; R 63 AMG 4-matic	giu-05	dic-14	7	AB6083AT	-	MB 236.21
MERCEDES-BENZ	CLASSE R (W251, V251)	R 280; R 280 CDI; R 280 CDI 4-matic; R 300; R 300 CDI; R 300 CDI 4-matic; R 320 CDI 4-matic; R 350; R 350 4-matic; R 350 CDI 4-matic; R 350 CGI 4-matic; R 500 4-matic; R 63 AMG 4-matic	giu-05	dic-14	7	AB6084AT	-	MB 236.21
MERCEDES-BENZ	CLASSE R (W251, V251)	R 280; R 300; R 350 CDI 4-matic; R 350 CGI 4-matic; R 500 4-matic	ago-05	dic-14	7	AB6082AT	-	MB 236.21
MERCEDES-BENZ	CLASSE S (V223)	S 350 d Mild Hybrid; S 350 d Mild Hybrid 4-matic; S 450 d Mild Hybrid 4-matic; S 450 EQ Boost; S 450 EQ Boost 4-matic; S 500 EQ Boost 4-matic; S 580 4-matic; S 63 AMG Hybrid 4-matic	set-20	In produzione	9	AB6086AT	-	MB 236.16
MERCEDES-BENZ	CLASSE S (V223)	S 350 d; S 350 d 4-matic; S 400 d 4-matic; S 450 EQ Boost; S 450 EQ Boost 4-matic; S 500 EQ Boost 4-matic	set-20	In produzione	9	AB6088AT	-	MB 236.16
MERCEDES-BENZ	CLASSE S (W126)	260 SE; 280 S; 280 SE, SEL; 3.8; 300 SE, SEL; 380 SE, SEL; 420 SE, SEL; 500 SE, SEL; 500 SE, SEL Cat; 560 SE, SEL	ott-79	giu-91	4	AB6076AT	-	MB A0009899203
MERCEDES-BENZ	CLASSE S (W126)	260 SE; 280 S; 280 SE, SEL; 3.8; 300 SE, SEL; 380 SE, SEL; 420 SE, SEL; 500 SE, SEL; 500 SE, SEL Cat; 560 SE, SEL	ott-79	giu-91	4	AB6077AT	-	DEXRON III
MERCEDES-BENZ	CLASSE S (W140)	300 SE, SEL; 400 SE, SEL/420; 300 SE 2.8; 500 SE, SEL; 600 SE, SEL; S 280; S 300 Turbo-D; S 350 Turbo-D; S 420; S 500; S 600	feb-91	ott-98	5	AB6078AT	-	MB 236.14
MERCEDES-BENZ	CLASSE S (W140)	300 SE, SEL; 400 SE, SEL/420; 300 SE 2.8; 500 SE, SEL; 600 SE, SEL; S 280; S 300 Turbo-D; S 350 Turbo-D; S 420; S 500; S 600	feb-91	ott-98	4	AB6077AT	-	DEXRON III
MERCEDES-BENZ	CLASSE S (W220)	S 280; S 320; S 320 CDI; S 350; S 350 4-matic; S 400 CDI; S 430; S 430 4-matic; S 500; S 500 4-matic; S 55 AMG; S 55 AMG Kompressor; S 600; S 63 AMG; S 65 AMG	ott-98	ago-05	5	AB6078AT	-	MB 236.14
MERCEDES-BENZ	CLASSE S (W220)	S 280; S 320; S 320 CDI; S 350; S 350 4-matic; S 400 CDI; S 430; S 430 4-matic; S 500; S 500 4-matic; S 55 AMG; S 55 AMG Kompressor; S 600; S 63 AMG; S 65 AMG	ott-98	ago-05	7	AB6177AT	-	MB 236.15
MERCEDES-BENZ	CLASSE S (W220)	S 430; S 500	ott-98	ago-05	7	AB6083AT	-	MB 236.21
MERCEDES-BENZ	CLASSE S (W220)	S 430; S 500	ott-98	ago-05	7	AB6084AT	-	MB 236.21
MERCEDES-BENZ	CLASSE S (W221)	S 250 CDI; S 280; S 300; S 320 CDI; S 320 CDI 4-matic; S 350; S 350 4-matic; S 350 BlueTec; S 350 BlueTEC 4-matic; S 350 CDI; S 350 CDI 4-matic; S 350 CGI; S 350 CGI 4-matic; S 400 Hybrid; S 420 CDI; S 450; S 450 4-matic; S 450 CDI; S 500; S 500 4-matic; S 500 CGI; S 500 CGI 4-matic; S 550; S 63 AMG	ott-05	dic-13	7	AB6083AT	-	MB 236.21
MERCEDES-BENZ	CLASSE S (W221)	S 250 CDI; S 280; S 300; S 320 CDI; S 320 CDI 4-matic; S 350; S 350 4-matic; S 350 BlueTec; S 350 BlueTEC 4-matic; S 350 CDI; S 350 CDI 4-matic; S 350 CGI; S 350 CGI 4-matic; S 400 Hybrid; S 420 CDI; S 450; S 450 4-matic; S 450 CDI; S 500; S 500 4-matic; S 500 CGI; S 500 CGI 4-matic; S 550; S 63 AMG	ott-05	dic-13	7	AB6084AT	-	MB 236.21
MERCEDES-BENZ	CLASSE S (W221)	S 250 CDI; S 280; S 300; S 320 CDI; S 320 CDI 4-matic; S 350; S 350 4-matic; S 350 BlueTec; S 350 BlueTEC 4-matic; S 350 CDI; S 350 CDI 4-matic; S 350 CGI; S 350 CGI 4-matic; S 400 Hybrid; S 420 CDI; S 450; S 450 4-matic; S 450 CDI; S 500; S 500 4-matic; S 500 CGI; S 500 CGI 4-matic; S 550; S 600; S 63 AMG; S 65 AMG	ott-05	dic-13	7	AB6177AT	-	MB 236.15

Marca / Brand:	Modello / Model:	Versioni / Version:	Da anno / From:	Ad anno / To:	Marce / Gears:	Codice AB PARTS		Lubrificante Consigliato
MERCEDES-BENZ	CLASSE S (W221)	S 350 4-matic	feb-08	dic-13	7	AB6082AT	-	MB 236.21
MERCEDES-BENZ	CLASSE S (W221)	S 600; S 65 AMG	dic-05	dic-13	5	AB6078AT	-	MB 236.14
MERCEDES-BENZ	CLASSE S (W222, V222, X222)	AMG S 63; AMG S 63 4-matic+	mag-17	lug-20	9	AB6086AT	-	MB 236.16
MERCEDES-BENZ	CLASSE S (W222, V222, X222)	S 350 BlueTEC; S 350 BlueTEC 4x4; S 320; S 350 BlueTEC 4-matic; S 400; S 400 4-matic; S 400 Maybach 4-matic; S 450; S 450 4-matic; S 450 EQ Boost; S 450 EQ Boost 4-matic; S 500; S 500 4-matic; S 500 Maybach; S 500 Maybach 4-matic; S 560; S 560 4-matic; S 560 e; S 560 Maybach; S 560 Maybach 4-matic; S 63 AMG; S 63 AMG 4-matic; S 65 AMG; S 650 Maybach	mag-13	lug-20	7	AB6082AT	-	MB 236.21
MERCEDES-BENZ	CLASSE S (W222, V222, X222)	S 350 BlueTEC; S 350 BlueTEC 4x4; S 320; S 350 BlueTEC 4-matic; S 400; S 400 4-matic; S 400 Maybach 4-matic; S 450; S 450 4-matic; S 450 EQ Boost; S 500; S 500 4-matic; S 500 Maybach; S 500 Maybach 4-matic; S 560 e; S 600; S 600 Maybach; S 63 AMG; S 63 AMG 4-matic; S 65 AMG; S 650 Maybach	mag-13	lug-20	7	AB6083AT	-	MB 236.21
MERCEDES-BENZ	CLASSE S (W222, V222, X222)	S 350 BlueTEC; S 350 BlueTEC 4x4; S 320; S 350 BlueTEC 4-matic; S 400; S 400 4-matic; S 400 Maybach 4-matic; S 450; S 450 4-matic; S 450 EQ Boost; S 500; S 500 Maybach; S 560 e; S 600; S 600 Maybach; S 63 AMG; S 65 AMG; S 650 Maybach	mag-13	lug-20	7	AB6084AT	-	MB 236.21
MERCEDES-BENZ	CLASSE S (W222, V222, X222)	S 350 BlueTEC; S 400 Hybrid; S 350 BlueTEC 4x4; S 320; S 350 BlueTEC 4-matic; S 350 d; S 350 d 4-matic; S 400; S 400 4-matic; S 400 d; S 400 d 4-matic; S 400 Maybach 4-matic; S 450; S 450 4-matic; S 450 EQ Boost; S 450 EQ Boost 4-matic; S 450 Maybach 4-matic; S 500; S 500 4-matic; S 500 EQ Boost; S 500 Maybach; S 500 Maybach 4-matic; S 560; S 560 4-matic; S 560 Maybach; S 560 Maybach 4-matic	mag-13	lug-20	9	AB6088AT	-	MB 236.16
MERCEDES-BENZ	CLASSE S (W222, V222, X222)	S 500 Hybrid; S 300 BlueTEC Hybrid; S 400 Hybrid; S 400 d; S 400 d 4-matic; S 450; S 450 EQ Boost 4-matic; S 560 4-matic; S 560 e	mag-13	lug-20	7	AB6085AT	-	MB236.15
MERCEDES-BENZ	CLASSE S (W222, V222, X222)	S 560 e	ott-18	lug-20	9	AB6087AT	-	MB 236.16
MERCEDES-BENZ	CLASSE S (W223)	S 350 d Mild Hybrid; S 350 d Mild Hybrid 4-matic; S 450 d Mild Hybrid 4-matic; S 450 EQ Boost; S 450 EQ Boost 4-matic; S 500 EQ Boost 4-matic; S 580 4-matic	set-20	In produzione	9	AB6086AT	-	MB 236.16
MERCEDES-BENZ	CLASSE S (W223)	S 350 d; S 350 d 4-matic; S 400 d 4-matic; S 450 EQ Boost; S 450 EQ Boost 4-matic; S 500 EQ Boost 4-matic	set-20	In produzione	9	AB6088AT	-	MB 236.16
MERCEDES-BENZ	CLASSE S (Z223)	S 580 Maybach EQ Boost 4-matic; S 680 Maybach 4-matic	mag-21	In produzione	9	AB6086AT	-	MB 236.16
MERCEDES-BENZ	CLASSE S Cabriolet (A217)	AMG S 63; AMG S 63 4-matic; AMG S 65; S 500; S 560; S 650 Maybach	dic-15	lug-20	7	AB6082AT	-	MB 236.21
MERCEDES-BENZ	CLASSE S Cabriolet (A217)	AMG S 63; AMG S 63 4-matic; AMG S 65; S 500; S 650 Maybach	dic-15	mag-19	7	AB6083AT	-	MB 236.21
MERCEDES-BENZ	CLASSE S Cabriolet (A217)	AMG S 63; AMG S 63 4-matic+	ott-17	lug-20	9	AB6086AT	-	MB 236.16
MERCEDES-BENZ	CLASSE S Cabriolet (A217)	AMG S 63; AMG S 65; S 500; S 650 Maybach	dic-15	mag-19	7	AB6084AT	-	MB 236.21
MERCEDES-BENZ	CLASSE S Cabriolet (A217)	S 500; S 560	dic-15	lug-20	9	AB6088AT	-	MB 236.16
MERCEDES-BENZ	CLASSE S Coupé (C126)	380 SEC; 420 SEC; 500 SEC; 500 SEC Cat; 560 SEC	ago-80	giu-91	4	AB6076AT	-	MB A0009899203
MERCEDES-BENZ	CLASSE S Coupé (C126)	380 SEC; 420 SEC; 500 SEC; 500 SEC Cat; 560 SEC	ago-80	giu-91	4	AB6077AT	-	DEXRON III
MERCEDES-BENZ	CLASSE S Coupé (C140)	500 SEC / CL500; SEC / CL420; SEC / CL600	set-92	dic-99	5	AB6078AT	-	MB 236.14
MERCEDES-BENZ	CLASSE S Coupé (C140)	500 SEC / CL500; SEC / CL420; SEC / CL600	set-92	dic-99	4	AB6077AT	-	DEXRON III
MERCEDES-BENZ	CLASSE S Coupé (C215)	CL 500	mar-99	mar-06	7	AB6083AT	-	MB 236.21
MERCEDES-BENZ	CLASSE S Coupé (C215)	CL 500	mar-99	mar-06	7	AB6084AT	-	MB 236.21
MERCEDES-BENZ	CLASSE S Coupé (C215)	CL 500; CL 55 AMG; CL 55 AMG Kompressor; CL 600; CL 63 AMG; CL 65 AMG	mar-99	mar-06	5	AB6078AT	-	MB 236.14
MERCEDES-BENZ	CLASSE S Coupé (C215)	CL 500; CL 55 AMG; CL 55 AMG Kompressor; CL 600; CL 63 AMG; CL 65 AMG	mar-99	mar-06	7	AB6177AT	-	MB 236.15
MERCEDES-BENZ	CLASSE S Coupé (C216)	CL 500; CL 500 4-matic; CL 600; CL 63 AMG; CL 65 AMG	mag-06	dic-13	7	AB6177AT	-	MB 236.15

Marca / Brand:	Modello / Model:	Versioni / Version:	Da anno / From:	Ad anno / To:	Marce / Gears:	Codice AB PARTS		Lubrificante Consigliato
MERCEDES-BENZ	CLASSE S Coupé (C216)	CL 500; CL 500 4-matic; CL 63 AMG; CL 65 AMG	giu-06	dic-13	7	AB6083AT	-	MB 236.21
MERCEDES-BENZ	CLASSE S Coupé (C216)	CL 500; CL 500 4-matic; CL 63 AMG; CL 65 AMG	giu-06	dic-13	7	AB6084AT	-	MB 236.21
MERCEDES-BENZ	CLASSE S Coupé (C216)	CL 600; CL 65 AMG	mag-06	dic-13	5	AB6078AT	-	MB 236.14
MERCEDES-BENZ	CLASSE S Coupé (C217)	S 400 4-matic; S 450 4-matic; S 500; S 500 4-matic; S 560; S 560 4-matic; S 63 AMG; S 63 AMG 4-matic; S 65 AMG	apr-14	lug-20	7	AB6082AT	-	MB 236.21
MERCEDES-BENZ	CLASSE S Coupé (C217)	S 400 4-matic; S 450 4-matic; S 500; S 500 4-matic; S 560; S 63 AMG; S 63 AMG 4-matic; S 65 AMG	apr-14	lug-20	7	AB6083AT	-	MB 236.21
MERCEDES-BENZ	CLASSE S Coupé (C217)	S 400 4-matic; S 450 4-matic; S 500; S 63 AMG; S 65 AMG	lug-14	lug-20	7	AB6084AT	-	MB 236.21
MERCEDES-BENZ	CLASSE S Coupé (C217)	S 400 4-matic; S 500; S 500 4-matic; S 560; S 560 4-matic	apr-14	lug-20	9	AB6088AT	-	MB 236.16
MERCEDES-BENZ	CLASSE S Coupé (C217)	S 63 AMG; S 63 AMG 4-matic+	ott-17	lug-20	9	AB6086AT	-	MB 236.16
MERCEDES-BENZ	CLASSE V (W447)	V 200 CDI; V 220 CDI; V 250 BlueTEC; V 250 CDI; V 300 CDI; V 200 CDI 4x4; V 220 CDI 4x4; V 250 BlueTEC 4x4; V 250 CDI 4x4; V 300 CDI 4x4	mar-14	In produzione	7	AB6082AT	-	MB 236.21
MERCEDES-BENZ	CLASSE V (W447)	V 200 CDI; V 220 CDI; V 250 BlueTEC; V 250 CDI; V 300 CDI; V 200 CDI 4x4; V 220 CDI 4x4; V 250 BlueTEC 4x4; V 250 CDI 4x4; V 300 CDI 4x4	mar-14	In produzione	7	AB6083AT	-	MB 236.21
MERCEDES-BENZ	CLASSE V (W447)	V 200 CDI; V 220 CDI; V 250 BlueTEC; V 250 CDI; V 300 CDI; V 200 CDI 4x4; V 220 CDI 4x4; V 250 BlueTEC 4x4; V 250 CDI 4x4; V 300 CDI 4x4	mar-14	In produzione	7	AB6084AT	-	MB 236.21
MERCEDES-BENZ	CLASSE V (W447)	V 200 CDI; V 220 CDI; V 250 BlueTEC; V 250 CDI; V 300 CDI; V 220 CDI 4x4; V 250 CDI 4x4; V 300 CDI 4x4	mar-14	In produzione	9	AB6088AT	-	MB 236.16
MERCEDES-BENZ	CLASSE X (470)	X 350 d 4-matic	lug-18	mag-20	7	AB6082AT	-	MB 236.21
MERCEDES-BENZ	CLASSE X (470)	X 350 d 4-matic	lug-18	mag-20	7	AB6083AT	-	MB 236.21
MERCEDES-BENZ	CLASSE X (470)	X 350 d 4-matic	lug-18	mag-20	7	AB6084AT	-	MB 236.21
MERCEDES-BENZ	CLK (C208)	CLK 200; CLK 200 Kompressor; CLK 230 Kompressor; CLK 320; CLK 430; CLK 55 AMG	giu-97	dic-03	5	AB6078AT	-	MB 236.14
MERCEDES-BENZ	CLK (C208)	CLK 200; CLK 200 Kompressor; CLK 230 Kompressor; CLK 320; CLK 430; CLK 55 AMG	giu-97	dic-03	7	AB6177AT	-	MB 236.15
MERCEDES-BENZ	CLK (C209)	CLK 200 CGI; CLK 200 Kompressor; CLK 220 CDI; CLK 240; CLK 270 CDI; CLK 280; CLK 320; CLK 320 CDI; CLK 350; CLK 500; CLK 55 AMG; CLK 63 AMG; CLK DTM AMG	giu-02	mag-09	5	AB6078AT	-	MB 236.14
MERCEDES-BENZ	CLK (C209)	CLK 200 CGI; CLK 200 Kompressor; CLK 220 CDI; CLK 240; CLK 270 CDI; CLK 280; CLK 320; CLK 320 CDI; CLK 350; CLK 500; CLK 55 AMG; CLK 63 AMG; CLK DTM AMG	giu-02	mag-09	7	AB6177AT	-	MB 236.15
MERCEDES-BENZ	CLK (C209)	CLK 280; CLK 320 CDI; CLK 350; CLK 500; CLK 55 AMG; CLK 63 AMG	giu-02	mag-09	7	AB6083AT	-	MB 236.21
MERCEDES-BENZ	CLK (C209)	CLK 280; CLK 320 CDI; CLK 350; CLK 500; CLK 55 AMG; CLK 63 AMG	giu-02	mag-09	7	AB6084AT	-	MB 236.21
MERCEDES-BENZ	CLK Cabriolet (A208)	CLK 200; CLK 200 Kompressor; CLK 230 Kompressor; CLK 320; CLK 430; CLK 55 AMG	mar-98	mar-02	5	AB6078AT	-	MB 236.14
MERCEDES-BENZ	CLK Cabriolet (A208)	CLK 200; CLK 200 Kompressor; CLK 230 Kompressor; CLK 320; CLK 430; CLK 55 AMG	mar-98	mar-02	7	AB6177AT	-	MB 236.15
MERCEDES-BENZ	CLK Cabriolet (A209)	CLK 200 CGI; CLK 200 Kompressor; CLK 240; CLK 280; CLK 320; CLK 320 CDI; CLK 350; CLK 500; CLK 55 AMG; CLK 63 AMG; CLK AMG DTM	giu-02	mar-10	5	AB6078AT	-	MB 236.14
MERCEDES-BENZ	CLK Cabriolet (A209)	CLK 200 CGI; CLK 200 Kompressor; CLK 240; CLK 280; CLK 320; CLK 320 CDI; CLK 350; CLK 500; CLK 55 AMG; CLK 63 AMG; CLK AMG DTM	giu-02	mar-10	7	AB6177AT	-	MB 236.15
MERCEDES-BENZ	CLK Cabriolet (A209)	CLK 280; CLK 320 CDI; CLK 350; CLK 500; CLK 55 AMG; CLK 63 AMG	giu-02	mar-10	7	AB6083AT	-	MB 236.21
MERCEDES-BENZ	CLK Cabriolet (A209)	CLK 280; CLK 320 CDI; CLK 350; CLK 500; CLK 55 AMG; CLK 63 AMG	giu-02	mar-10	7	AB6084AT	-	MB 236.21
MERCEDES-BENZ	CLS (C218)	CLS 220 BlueTEC; CLS 350 BlueTEC; CLS 350 CDI; CLS 250 BlueTEC 4x4; CLS 350 BlueTEC 4x4; CLS 350 CDI 4x4; CLS 250 CDI; CLS 350; CLS 350 d 4-matic; CLS 400; CLS 400 4-matic; CLS 500; CLS 500 4-matic; CLS 63 AMG; CLS 63 AMG 4-matic	gen-11	dic-17	7	AB6082AT	-	MB 236.21

Marca / Brand:	Modello / Model:	Versioni / Version:	Da anno / From:	Ad anno / To:	Marce / Gears:	Codice AB PARTS		Lubrificante Consigliato
MERCEDES-BENZ	CLS (C218)	CLS 220 BlueTEC; CLS 350 BlueTEC; CLS 350 CDI; CLS 250 BlueTEC 4x4; CLS 350 BlueTEC 4x4; CLS 350 CDI 4x4; CLS 250 CDI; CLS 350; CLS 350 d 4-matic; CLS 400; CLS 400 4-matic; CLS 500; CLS 500 4-matic; CLS 63 AMG; CLS 63 AMG 4-matic	gen-11	dic-17	7	AB6083AT	-	MB 236.21
MERCEDES-BENZ	CLS (C218)	CLS 220 BlueTEC; CLS 350 BlueTEC; CLS 350 CDI; CLS 250 BlueTEC 4x4; CLS 350 BlueTEC 4x4; CLS 350 CDI 4x4; CLS 250 CDI; CLS 350; CLS 350 d 4-matic; CLS 400; CLS 400 4-matic; CLS 500; CLS 500 4-matic; CLS 63 AMG; CLS 63 AMG 4-matic	gen-11	dic-17	7	AB6177AT	-	MB 236.15
MERCEDES-BENZ	CLS (C218)	CLS 220 BlueTEC; CLS 350 BlueTEC; CLS 350 CDI; CLS 250 BlueTEC 4x4; CLS 350 BlueTEC 4x4; CLS 350 CDI 4x4; CLS 250 CDI; CLS 350; CLS 350 d 4-matic; CLS 400; CLS 400 4-matic; CLS 500; CLS 63 AMG	gen-11	dic-17	7	AB6084AT	-	MB 236.21
MERCEDES-BENZ	CLS (C218)	CLS 220 BlueTEC; CLS 350 BlueTEC; CLS 350 CDI; CLS 350 BlueTEC 4x4; CLS 250 CDI; CLS 350; CLS 350 d 4-matic; CLS 400; CLS 400 4-matic; CLS 500; CLS 500 4-matic	gen-11	dic-17	9	AB6088AT	-	MB 236.16
MERCEDES-BENZ	CLS (C219)	CLS 280; CLS 300; CLS 320 CDI; CLS 350; CLS 350 CDI; CLS 500; CLS 55 AMG; CLS 63 AMG	ott-04	dic-10	7	AB6177AT	-	MB 236.15
MERCEDES-BENZ	CLS (C219)	CLS 280; CLS 300; CLS 320 CDI; CLS 350; CLS 350 CDI; CLS 500; CLS 63 AMG	ott-04	dic-10	7	AB6083AT	-	MB 236.21
MERCEDES-BENZ	CLS (C219)	CLS 280; CLS 300; CLS 320 CDI; CLS 350; CLS 350 CDI; CLS 500; CLS 63 AMG	ott-04	dic-10	7	AB6084AT	-	MB 236.21
MERCEDES-BENZ	CLS (C219)	CLS 55 AMG	gen-05	dic-10	5	AB6078AT	-	MB 236.14
MERCEDES-BENZ	CLS (C257)	AMG CLS 53 EQ Boost 4-matic+; CLS 220 d; CLS 300 d; CLS 350 d; CLS 350 d 4-matic; CLS 350 EQ Boost; CLS 350 EQ Boost 4-matic; CLS 400 d 4-matic; CLS 450 EQ Boost 4-matic	dic-17	In produzione	9	AB6088AT	-	MB 236.16
MERCEDES-BENZ	CLS (C257)	CLS 300 d 4-matic	apr-21	In produzione	9	AB6086AT	-	MB 236.16
MERCEDES-BENZ	CLS Shooting Brake (X218)	CLS 220 BlueTEC; CLS 350 BlueTEC; CLS 350 CDI; CLS 250 BlueTEC 4x4; CLS 350 BlueTEC 4x4; CLS 350 CDI 4x4; CLS 250 CDI; CLS 350; CLS 350 d 4-matic; CLS 400; CLS 400 4-matic; CLS 500; CLS 500 4-matic; CLS 63 AMG; CLS 63 AMG 4-matic	ott-12	dic-17	7	AB6082AT	-	MB 236.21
MERCEDES-BENZ	CLS Shooting Brake (X218)	CLS 220 BlueTEC; CLS 350 BlueTEC; CLS 350 CDI; CLS 250 BlueTEC 4x4; CLS 350 BlueTEC 4x4; CLS 350 CDI 4x4; CLS 250 CDI; CLS 350; CLS 350 d 4-matic; CLS 400; CLS 400 4-matic; CLS 500; CLS 500 4-matic; CLS 63 AMG; CLS 63 AMG 4-matic	ott-12	dic-17	7	AB6083AT	-	MB 236.21
MERCEDES-BENZ	CLS Shooting Brake (X218)	CLS 220 BlueTEC; CLS 350 BlueTEC; CLS 350 CDI; CLS 250 BlueTEC 4x4; CLS 350 BlueTEC 4x4; CLS 350 CDI 4x4; CLS 250 CDI; CLS 350; CLS 350 d 4-matic; CLS 400; CLS 400 4-matic; CLS 500; CLS 500 4-matic; CLS 63 AMG; CLS 63 AMG 4-matic	ott-12	dic-17	7	AB6177AT	-	MB 236.15
MERCEDES-BENZ	CLS Shooting Brake (X218)	CLS 220 BlueTEC; CLS 350 BlueTEC; CLS 350 CDI; CLS 250 BlueTEC 4x4; CLS 350 BlueTEC 4x4; CLS 350 CDI 4x4; CLS 250 CDI; CLS 350; CLS 350 d 4-matic; CLS 400; CLS 400 4-matic; CLS 500; CLS 63 AMG	ott-12	dic-17	7	AB6084AT	-	MB 236.21
MERCEDES-BENZ	CLS Shooting Brake (X218)	CLS 220 BlueTEC; CLS 350 BlueTEC; CLS 350 CDI; CLS 350 BlueTEC 4x4; CLS 250 CDI; CLS 350; CLS 350 d 4-matic; CLS 400; CLS 500; CLS 500 4-matic	ott-12	dic-17	9	AB6088AT	-	MB 236.16
MERCEDES-BENZ	eVITO Furgonato (W447)	eVITO	mar-19	In produzione	9	AB6088AT	-	MB 236.16
MERCEDES-BENZ	eVITO Tourer (W447)	eVITO	apr-19	In produzione	9	AB6088AT	-	MB 236.16
MERCEDES-BENZ	GLC (X253)	200 4-matic; 220 d 4-matic; 250 4-matic; 250 d 4-matic; 300 4-matic; AMG 43 4-matic; AMG 63 4-matic+; AMG 63 S 4-matic+	giu-15	giu-22	9	AB6086AT	-	MB 236.16
MERCEDES-BENZ	GLC (X253)	200 d; 200 d 4-matic; 200 EQ Boost; 200 EQ Boost 4-matic; 220 d; 220 d 4-matic; 250 4-matic; 250 d 4-matic; 300 4-matic; 300 d 4-matic; 300 EQ Boost 4-matic; 350 d 4-matic; 400 d 4-matic; AMG 43 4-matic	giu-15	giu-22	9	AB6088AT	-	MB 236.16
MERCEDES-BENZ	GLC (X253)	300 e 4-matic; 300 e 4-matic; 350 e 4-matic	gen-16	giu-22	9	AB6087AT	-	MB 236.16
MERCEDES-BENZ	GLC (X253)	300 e 4-matic; 350 e 4-matic	gen-16	giu-22	7	AB6085AT	-	MB236.15

Marca / Brand:	Modello / Model:	Versioni / Version:	Da anno / From:	Ad anno / To:	Marce / Gears:	Codice AB PARTS		Lubrificante Consigliato
MERCEDES-BENZ	GLC (X253)	350 e 4-matic	gen-16	apr-19	7	AB6082AT	-	MB 236.21
MERCEDES-BENZ	GLC (X253)	350 e 4-matic	gen-16	apr-19	7	AB6083AT	-	MB 236.21
MERCEDES-BENZ	GLC (X254)	200 4-matic; 220d 4-matic; 300 4-matic; 300d 4-matic; AMG 43 4-matic; AMG 63S E Performance 4-matic	giu-22	In produzione	9	AB6086AT	-	MB 236.16
MERCEDES-BENZ	GLC Coupe (C253)	200 d; 200 d 4-matic; 200 EQ Boost; 200 EQ Boost 4-matic; 220 d 4-matic; 250 4-matic; 250 d 4-matic; 300 4-matic; 300 d 4-matic; 300 EQ Boost 4-matic; 350 d 4-matic; 400 d 4-matic; AMG 43 4-matic	giu-16	mar-23	9	AB6088AT	-	MB 236.16
MERCEDES-BENZ	GLC Coupe (C253)	220 d 4-matic; 250 4-matic; 250 d 4-matic; 300 4-matic; AMG 43 4-matic; AMG 63 4-matic+; AMG 63 S 4-matic+	giu-16	mar-23	9	AB6086AT	-	MB 236.16
MERCEDES-BENZ	GLC Coupe (C253)	300 de 4-matic; 300 e 4-matic; 350 e 4-matic	ott-16	mar-23	9	AB6087AT	-	MB 236.16
MERCEDES-BENZ	GLC Coupe (C253)	350 e 4-matic	ott-16	apr-19	7	AB6082AT	-	MB 236.21
MERCEDES-BENZ	GLC Coupe (C253)	350 e 4-matic	ott-16	apr-19	7	AB6085AT	-	MB236.15
MERCEDES-BENZ	GLC Coupe (C254)	200 4-matic; 220d 4-matic; 300 4-matic; 300d 4-matic	giu-22	In produzione	9	AB6086AT	-	MB 236.16
MERCEDES-BENZ	GLE (V167)	AMG GLE 53 EQ Boost 4-matic+; AMG GLE 63 EQ Boost 4-matic+; AMG GLE 63 S EQ Boost 4-matic+; GLE 300 d 4-matic; GLE 300 d EQ Boost 4-matic; GLE 450 4-matic; GLE 450 d 4-matic; GLE 450 EQ Boost 4-matic; GLE 580 4-matic	ott-18	In produzione	9	AB6086AT	-	MB 236.16
MERCEDES-BENZ	GLE (V167)	AMG GLE 53 EQ Boost 4-matic+; GLE 300 d 4-matic; GLE 300 d EQ Boost 4-matic; GLE 350 d 4-matic; GLE 400 d 4-matic; GLE 450 EQ Boost 4-matic; GLE 580 EQ Boost 4-matic	ott-18	In produzione	9	AB6088AT	-	MB 236.16
MERCEDES-BENZ	GLE (V167)	GLE 350 de 4-matic	mar-20	mar-23	9	AB6087AT	-	MB 236.16
MERCEDES-BENZ	GLE (W166)	250 d; 250 d 4-matic; 320 4-matic; 350 d 4-matic; 400 4-matic; 450 AMG 4-matic; 500 4-matic; AMG 43 4-matic	apr-15	ott-18	9	AB6086AT	-	MB 236.16
MERCEDES-BENZ	GLE (W166)	250 d; 250 d 4-matic; 320 4-matic; 350 d 4-matic; 400 4-matic; 450 AMG 4-matic; 500 4-matic; AMG 43 4-matic; AMG 63 4-matic; AMG 63 S 4-matic	apr-15	ott-18	7	AB6082AT	-	MB 236.21
MERCEDES-BENZ	GLE (W166)	250 d; 250 d 4-matic; 320 4-matic; 350 d 4-matic; 400 4-matic; 450 AMG 4-matic; 500 4-matic; AMG 43 4-matic; AMG 63 4-matic; AMG 63 S 4-matic	apr-15	ott-18	7	AB6083AT	-	MB 236.21
MERCEDES-BENZ	GLE (W166)	250 d; 250 d 4-matic; 320 4-matic; 350 d 4-matic; 400 4-matic; 450 AMG 4-matic; 500 4-matic; AMG 43 4-matic; AMG 63 4-matic; AMG 63 S 4-matic	apr-15	ott-18	7	AB6084AT	-	MB 236.21
MERCEDES-BENZ	GLE (W166)	250 d; 250 d 4-matic; 350 d 4-matic; 400 4-matic; 450 AMG 4-matic; 500 4-matic; 500 e 4-matic; AMG 43 4-matic	apr-15	ott-18	9	AB6088AT	-	MB 236.16
MERCEDES-BENZ	GLE (W166)	500 4-matic; 500 e 4-matic	apr-15	ott-18	9	AB6087AT	-	MB 236.16
MERCEDES-BENZ	GLE Coupe (C167)	AMG GLE 53 EQ Boost 4-matic+; AMG GLE 63 EQ Boost 4-matic+; GLE 300 d 4-matic; GLE 300 d EQ Boost 4-matic; GLE 450 d 4-matic	nov-19	In produzione	9	AB6086AT	-	MB 236.16
MERCEDES-BENZ	GLE Coupe (C167)	AMG GLE 53 EQ Boost 4-matic+; GLE 350 d 4-matic; GLE 400 d 4-matic	nov-19	In produzione	9	AB6088AT	-	MB 236.16
MERCEDES-BENZ	GLE Coupe (C292)	350 d 4-matic; 400 4-matic; 450 AMG 4-matic; 500 4-matic; AMG 43 4-matic	mar-15	ott-19	9	AB6088AT	-	MB 236.16
MERCEDES-BENZ	GLE Coupe (C292)	350 d 4-matic; 400 4-matic; 450 AMG 4-matic; 500 4-matic; AMG 43 4-matic	mar-15	ott-19	9	AB6086AT	-	MB 236.16
MERCEDES-BENZ	GLE Coupe (C292)	350 d 4-matic; 400 4-matic; 450 AMG 4-matic; 500 4-matic; AMG 43 4-matic; AMG 63 4-matic; AMG 63 S 4-matic	mar-15	ott-19	7	AB6082AT	-	MB 236.21
MERCEDES-BENZ	GLE Coupe (C292)	350 d 4-matic; 400 4-matic; 450 AMG 4-matic; 500 4-matic; AMG 43 4-matic; AMG 63 4-matic; AMG 63 S 4-matic	mar-15	ott-19	7	AB6083AT	-	MB 236.21
MERCEDES-BENZ	GLE Coupe (C292)	350 d 4-matic; 400 4-matic; 450 AMG 4-matic; 500 4-matic; AMG 43 4-matic; AMG 63 4-matic; AMG 63 S 4-matic	mar-15	ott-19	7	AB6084AT	-	MB 236.21
MERCEDES-BENZ	GLE Coupe (C292)	500 4-matic	ott-15	ott-19	9	AB6087AT	-	MB 236.16
MERCEDES-BENZ	GLS (X166)	350 d 4-matic; 400 4-matic; 500 4-matic	nov-15	apr-19	9	AB6088AT	-	MB 236.16
MERCEDES-BENZ	GLS (X166)	350 d 4-matic; 400 4-matic; 500 4-matic; AMG 63 4-matic	nov-15	apr-19	7	AB6082AT	-	MB 236.21
MERCEDES-BENZ	GLS (X166)	350 d 4-matic; 400 4-matic; 500 4-matic; AMG 63 4-matic	nov-15	apr-19	7	AB6083AT	-	MB 236.21

Marca / Brand:	Modello / Model:	Versioni / Version:	Da anno / From:	Ad anno / To:	Marce / Gears:	Codice AB PARTS		Lubrificante Consigliato
MERCEDES-BENZ	GLS (X166)	350 d 4-matic; 400 4-matic; 500 4-matic; AMG 63 4-matic	nov-15	apr-19	7	AB6084AT	-	MB 236.21
MERCEDES-BENZ	GLS (X166)	400 4-matic; 500 4-matic	nov-15	apr-19	9	AB6086AT	-	MB 236.16
MERCEDES-BENZ	GLS (X166)	500 4-matic	nov-15	apr-19	9	AB6087AT	-	MB 236.16
MERCEDES-BENZ	GLS (X167)	350 d 4-matic; 400 d 4-matic; 450 EQ Boost 4-matic; 580 EQ Boost 4-matic; Maybach 600 EQ Boost 4-matic	apr-19	In produzione	9	AB6088AT	-	MB 236.16
MERCEDES-BENZ	GLS (X167)	350 d Mild Hybrid 4-matic; 450 d Mild-Hybrid 4-matic; 450 EQ Boost 4-matic; 450 Mild-Hybrid 4-matic; 580 4-matic; AMG 63 4Matic+ EQ Boost 4-matic+; Maybach 600 EQ Boost 4-matic	giu-19	In produzione	9	AB6086AT	-	MB 236.16
MERCEDES-BENZ	MARCO POLO Camper (W447)	160 CDI; 180 CDI; 200 CDI; 200 CDI 4-matic; 220 CDI; 220 CDI 4-matic; 250 CDI; 250 CDI 4-matic	mar-15	In produzione	9	AB6088AT	-	MB 236.16
MERCEDES-BENZ	MARCO POLO Camper (W447)	160 CDI; 180 CDI; 200 CDI; 200 CDI 4-matic; 220 CDI; 220 CDI 4-matic; 250 CDI; 250 CDI 4-matic; 300 CDI; 300 CDI 4-matic	mar-15	In produzione	7	AB6082AT	-	MB 236.21
MERCEDES-BENZ	MARCO POLO Camper (W447)	160 CDI; 180 CDI; 200 CDI; 200 CDI 4-matic; 220 CDI; 220 CDI 4-matic; 250 CDI; 250 CDI 4-matic; 300 CDI; 300 CDI 4-matic	mar-15	In produzione	7	AB6084AT	-	MB 236.21
MERCEDES-BENZ	MARCO POLO Camper (W447)	200 CDI; 200 CDI 4-matic; 220 CDI; 220 CDI 4-matic; 250 CDI; 250 CDI 4-matic; 300 CDI; 300 CDI 4-matic	mar-15	In produzione	7	AB6083AT	-	MB 236.21
MERCEDES-BENZ	SL (R107)	280 SL; 300 SL; 350 SL; 380 SL; 420 SL; 450 SL; 500 SL; 560 SL	mag-71	dic-89	4	AB6077AT	-	DEXRON III
MERCEDES-BENZ	SL (R129)	280; 300 SL; 300 SL-24; 320; 500; 500 SL; 55 AMG; 60 AMG; 600; 600 SL; SL 73 AMG	mar-89	dic-01	5	AB6078AT	-	MB 236.14
MERCEDES-BENZ	SL (R129)	280; 300 SL; 300 SL-24; 320; 500; 500 SL; 55 AMG; 60 AMG; 600; SL 73 AMG	mar-89	dic-01	4	AB6076AT	-	MB A0009899203
MERCEDES-BENZ	SL (R129)	280; 300 SL; 300 SL-24; 320; 500; 500 SL; 55 AMG; 60 AMG; 600; SL 73 AMG	mar-89	dic-01	4	AB6077AT	-	DEXRON III
MERCEDES-BENZ	SL (R230)	280; 300; 350	mar-08	gen-12	7	AB6082AT	-	MB 236.21
MERCEDES-BENZ	SL (R230)	280; 300; 350; 500; 55 AMG; 55 AMG Kompressor; 600; 63 AMG; 65 AMG; 65 AMG Black Series	ott-01	gen-12	5	AB6078AT	-	MB 236.14
MERCEDES-BENZ	SL (R230)	280; 300; 350; 500; 55 AMG; 55 AMG Kompressor; 600; 63 AMG; 65 AMG; 65 AMG Black Series	ott-01	gen-12	7	AB6177AT	-	MB 236.15
MERCEDES-BENZ	SL (R230)	280; 300; 350; 500; 63 AMG	ott-01	gen-12	7	AB6083AT	-	MB 236.21
MERCEDES-BENZ	SL (R230)	280; 300; 350; 500; 63 AMG	ott-01	gen-12	7	AB6084AT	-	MB 236.21
MERCEDES-BENZ	SL (R231)	350; 400; 500; 63 AMG; 65 AMG	gen-12	apr-20	7	AB6082AT	-	MB 236.21
MERCEDES-BENZ	SL (R231)	350; 400; 500; 63 AMG; 65 AMG	gen-12	apr-20	7	AB6083AT	-	MB 236.21
MERCEDES-BENZ	SL (R231)	350; 400; 500; 63 AMG; 65 AMG	gen-12	apr-20	7	AB6084AT	-	MB 236.21
MERCEDES-BENZ	SL (R231)	350; 400; 500; 63 AMG; 65 AMG	gen-12	apr-20	7	AB6177AT	-	MB 236.15
MERCEDES-BENZ	SL (R231)	400; 500	gen-12	apr-20	9	AB6088AT	-	MB 236.16
MERCEDES-BENZ	SL (R232)	43 AMG; 55 AMG 4-matic+; 63 AMG 4-matic+	mar-22	In produzione	9	AB6086AT	-	MB 236.16
MERCEDES-BENZ	SLC (R172)	180; 200; 250 d; 300; AMG SLC 43	gen-16	In produzione	9	AB6088AT	-	MB 236.16
MERCEDES-BENZ	SLC (R172)	180; 200; 250 d; AMG SLC 43	gen-16	In produzione	7	AB6082AT	-	MB 236.21
MERCEDES-BENZ	SLC (R172)	180; 200; 250 d; AMG SLC 43	gen-16	In produzione	7	AB6083AT	-	MB 236.21
MERCEDES-BENZ	SLC (R172)	180; 200; 250 d; AMG SLC 43	gen-16	In produzione	7	AB6084AT	-	MB 236.21
MERCEDES-BENZ	SLC (R172)	180; 200; 300	gen-16	In produzione	9	AB6086AT	-	MB 236.16
MERCEDES-BENZ	SLK (R170)	200; 200 Kompressor; 230 Kompressor; 32 AMG Kompressor; 320	set-96	apr-04	5	AB6078AT	-	MB 236.14
MERCEDES-BENZ	SLK (R171)	200 Kompressor; 280; 300; 350; 55 AMG	mar-04	feb-11	5	AB6078AT	-	MB 236.14
MERCEDES-BENZ	SLK (R171)	200 Kompressor; 280; 300; 350; 55 AMG	mar-04	feb-11	7	AB6177AT	-	MB 236.15
MERCEDES-BENZ	SLK (R171)	280; 300; 350; 55 AMG	giu-04	dic-11	7	AB6082AT	-	MB 236.21
MERCEDES-BENZ	SLK (R171)	280; 300; 350; 55 AMG	giu-04	dic-11	7	AB6083AT	-	MB 236.21
MERCEDES-BENZ	SLK (R171)	280; 300; 350; 55 AMG	giu-04	dic-11	7	AB6084AT	-	MB 236.21

Marca / Brand:	Modello / Model:	Versioni / Version:	Da anno / From:	Ad anno / To:	Marce / Gears:	Codice AB PARTS		Lubrificante Consigliato
MERCEDES-BENZ	SLK (R172)	200; 300	apr-15	In produzione	9	AB6086AT	-	MB 236.16
MERCEDES-BENZ	SLK (R172)	250 CDI; 200; 250; 300; 350; 55 AMG	feb-11	In produzione	7	AB6082AT	-	MB 236.21
MERCEDES-BENZ	SLK (R172)	250 CDI; 200; 250; 300; 350; 55 AMG	feb-11	In produzione	7	AB6177AT	-	MB 236.15
MERCEDES-BENZ	SLK (R172)	250 CDI; 200; 250; 350; 55 AMG	feb-11	In produzione	7	AB6083AT	-	MB 236.21
MERCEDES-BENZ	SLK (R172)	250 CDI; 200; 250; 350; 55 AMG	feb-11	In produzione	7	AB6084AT	-	MB 236.21
MERCEDES-BENZ	SLK (R172)	250 CDI; 200; 300	gen-12	In produzione	9	AB6088AT	-	MB 236.16
MERCEDES-BENZ	SLR (R199)	5.4; 5.4 722 Edition	apr-04	In produzione	5	AB6078AT	-	MB 236.14
MERCEDES-BENZ	SLR Roadster (R199)	5.4	ott-06	In produzione	5	AB6078AT	-	MB 236.14
MERCEDES-BENZ	SPRINTER 2-t Autobus (B901, B902)	208 CDI; 208 D; 210 D; 211 CDI; 212 D; 213 CDI; 214; 214 NGT; 216 CDI	feb-95	mag-06	5	AB6078AT	-	MB 236.14
MERCEDES-BENZ	SPRINTER 2-t Furgone (B901, B902)	208 CDI; 208 D; 210 D; 211 CDI; 212 D; 213 CDI; 214; 214 NGT; 216 CDI	feb-95	mag-06	5	AB6078AT	-	MB 236.14
MERCEDES-BENZ	SPRINTER 2-t Pianale piatto/Telaio (B901, B902)	208 CDI; 208 D; 210 D; 211 CDI; 212 D; 213 CDI; 214; 214 NGT; 216 CDI	gen-95	mag-06	5	AB6078AT	-	MB 236.14
MERCEDES-BENZ	SPRINTER 3,5-t Autobus (B906)	319 CDI; 319 CDI 4x4; 309 CDI; 310 CDI; 311 CDI; 311 CDI 4x4; 313 CDI; 313 CDI 4x4; 314 CDI; 314 CDI 4x4; 315 CDI; 315 CDI 4x4; 316; 316 CDI; 316 CDI 4x4; 316 LGT; 316 NGT; 318 CDI; 318 CDI 4x4; 324	giu-06	dic-19	5	AB6078AT	-	MB 236.14
MERCEDES-BENZ	SPRINTER 3,5-t Autobus (B906)	319 CDI; 319 CDI 4x4; 309 CDI; 310 CDI; 311 CDI; 311 CDI 4x4; 313 CDI; 313 CDI 4x4; 314 CDI; 314 CDI 4x4; 315 CDI; 315 CDI 4x4; 316; 316 CDI; 316 CDI 4x4; 316 LGT; 316 NGT; 318 CDI; 318 CDI 4x4; 324	giu-06	dic-19	7	AB6082AT	-	MB 236.21
MERCEDES-BENZ	SPRINTER 3,5-t Autobus (B906)	319 CDI; 319 CDI 4x4; 309 CDI; 310 CDI; 313 CDI; 313 CDI 4x4; 316; 316 CDI; 316 CDI 4x4; 316 LGT; 316 NGT; 324	giu-06	dic-19	7	AB6177AT	-	MB 236.15
MERCEDES-BENZ	SPRINTER 3,5-t Autobus (B906)	319 CDI; 319 CDI 4x4; 310 CDI; 311 CDI; 311 CDI 4x4; 313 CDI; 313 CDI 4x4; 314 CDI; 314 CDI 4x4; 315 CDI; 315 CDI 4x4; 316; 316 CDI; 316 CDI 4x4; 316 LGT; 316 NGT; 318 CDI; 318 CDI 4x4; 324	giu-06	dic-18	7	AB6084AT	-	MB 236.21
MERCEDES-BENZ	SPRINTER 3,5-t Autobus (B906)	319 CDI; 319 CDI 4x4; 311 CDI; 311 CDI 4x4; 313 CDI; 313 CDI 4x4; 314 CDI; 314 CDI 4x4; 315 CDI; 315 CDI 4x4; 316; 316 CDI; 316 CDI 4x4; 316 LGT; 316 NGT; 318 CDI; 318 CDI 4x4; 324	giu-06	dic-18	7	AB6083AT	-	MB 236.21
MERCEDES-BENZ	SPRINTER 3,5-t Furgone (B906)	319 CDI; 319 CDI 4x4; 309 CDI; 310 CDI; 311 CDI; 311 CDI 4x4; 313 CDI; 313 CDI 4x4; 314 CDI; 314 CDI 4x4; 315 CDI; 315 CDI 4x4; 316; 316 CDI; 316 CDI 4x4; 316 LGT; 316 NGT; 318 CDI; 318 CDI 4x4; 324	giu-06	dic-18	5	AB6078AT	-	MB 236.14
MERCEDES-BENZ	SPRINTER 3,5-t Furgone (B906)	319 CDI; 319 CDI 4x4; 309 CDI; 310 CDI; 311 CDI; 311 CDI 4x4; 313 CDI; 313 CDI 4x4; 314 CDI; 314 CDI 4x4; 315 CDI; 315 CDI 4x4; 316; 316 CDI; 316 CDI 4x4; 316 LGT; 316 NGT; 318 CDI; 318 CDI 4x4; 324	giu-06	dic-18	7	AB6082AT	-	MB 236.21
MERCEDES-BENZ	SPRINTER 3,5-t Furgone (B906)	319 CDI; 319 CDI 4x4; 309 CDI; 310 CDI; 311 CDI; 311 CDI 4x4; 313 CDI; 313 CDI 4x4; 314 CDI; 314 CDI 4x4; 315 CDI; 315 CDI 4x4; 316; 316 CDI; 316 CDI 4x4; 316 LGT; 316 NGT; 318 CDI; 318 CDI 4x4; 324	giu-06	dic-18	7	AB6084AT	-	MB 236.21
MERCEDES-BENZ	SPRINTER 3,5-t Furgone (B906)	319 CDI; 319 CDI 4x4; 309 CDI; 310 CDI; 311 CDI; 311 CDI 4x4; 313 CDI; 313 CDI 4x4; 314 CDI; 314 CDI 4x4; 315 CDI; 315 CDI 4x4; 316; 316 CDI; 316 CDI 4x4; 316 LGT; 316 NGT; 318 CDI; 318 CDI 4x4; 324	giu-06	dic-18	7	AB6083AT	-	MB 236.21
MERCEDES-BENZ	SPRINTER 3,5-t Furgone (B906)	319 CDI; 319 CDI 4x4; 310 CDI; 313 CDI; 313 CDI 4x4; 316; 316 CDI; 316 CDI 4x4; 316 LGT; 316 NGT; 324	giu-06	dic-18	7	AB6177AT	-	MB 236.15
MERCEDES-BENZ	SPRINTER 3,5-t Furgone (B907, B910)	311 CDI RWD; 314 CDI RWD; 314 CDI AWD; 316 CDI RWD; 316 CDI AWD; 319 CDI RWD; 319 CDI AWD	feb-18	In produzione	7	AB6084AT	-	MB 236.21
MERCEDES-BENZ	SPRINTER 3,5-t Furgone (B907, B910)	311 CDI; 311 CDI RWD; 314 CDI; 314 CDI RWD; 314 CDI AWD; 315 CDI; 315 CDI RWD; 316 CDI RWD; 316 CDI AWD; 317 CDI; 317 CDI RWD; 319 CDI RWD; 319 CDI AWD	feb-18	In produzione	7	AB6083AT	-	MB 236.21
MERCEDES-BENZ	SPRINTER 3,5-t Furgone (B907, B910)	311 CDI; 311 CDI RWD; 314 CDI; 314 CDI RWD; 314 CDI AWD; 316 CDI RWD; 316 CDI AWD; 319 CDI RWD; 319 CDI AWD	feb-18	In produzione	7	AB6082AT	-	MB 236.21

Marca / Brand:	Modello / Model:	Versioni / Version:	Da anno / From:	Ad anno / To:	Marce / Gears:	Codice AB PARTS		Lubrificante Consigliato
MERCEDES-BENZ	SPRINTER 3,5-t Pianale piatto/Telaio (B906)	319 CDI; 319 CDI 4x4; 309 CDI; 310 CDI; 311 CDI; 311 CDI 4x4; 313 CDI; 313 CDI 4x4; 314 CDI; 314 CDI 4x4; 315 CDI; 315 CDI 4x4; 316; 316 CDI; 316 CDI 4x4; 316 LGT; 316 NGT; 318 CDI; 318 CDI 4x4; 324	giu-06	dic-18	5	AB6078AT	-	MB 236.14
MERCEDES-BENZ	SPRINTER 3,5-t Pianale piatto/Telaio (B906)	319 CDI; 319 CDI 4x4; 309 CDI; 310 CDI; 311 CDI; 311 CDI 4x4; 313 CDI; 313 CDI 4x4; 314 CDI; 314 CDI 4x4; 315 CDI; 315 CDI 4x4; 316; 316 CDI; 316 CDI 4x4; 316 LGT; 316 NGT; 318 CDI; 318 CDI 4x4; 324	giu-06	dic-18	7	AB6082AT	-	MB 236.21
MERCEDES-BENZ	SPRINTER 3,5-t Pianale piatto/Telaio (B906)	319 CDI; 319 CDI 4x4; 309 CDI; 310 CDI; 311 CDI; 311 CDI 4x4; 313 CDI; 313 CDI 4x4; 314 CDI; 314 CDI 4x4; 315 CDI; 315 CDI 4x4; 316; 316 CDI; 316 CDI 4x4; 316 LGT; 316 NGT; 318 CDI; 318 CDI 4x4; 324	giu-06	dic-18	7	AB6083AT	-	MB 236.21
MERCEDES-BENZ	SPRINTER 3,5-t Pianale piatto/Telaio (B906)	319 CDI; 319 CDI 4x4; 309 CDI; 310 CDI; 311 CDI; 311 CDI 4x4; 313 CDI; 313 CDI 4x4; 314 CDI; 314 CDI 4x4; 315 CDI; 315 CDI 4x4; 316; 316 CDI; 316 CDI 4x4; 316 LGT; 316 NGT; 318 CDI; 318 CDI 4x4; 324	giu-06	dic-18	7	AB6084AT	-	MB 236.21
MERCEDES-BENZ	SPRINTER 3,5-t Pianale piatto/Telaio (B906)	319 CDI; 319 CDI 4x4; 310 CDI; 313 CDI; 313 CDI 4x4; 316; 316 CDI; 316 CDI 4x4; 316 LGT; 316 NGT; 324	giu-06	dic-18	7	AB6177AT	-	MB 236.15
MERCEDES-BENZ	SPRINTER 3,5-t Pianale piatto/Telaio (B907, B910)	311 CDI RWD; 314 CDI RWD; 314 CDI AWD; 316 CDI RWD; 316 CDI AWD; 319 CDI RWD; 319 CDI AWD	feb-18	In produzione	7	AB6084AT	-	MB 236.21
MERCEDES-BENZ	SPRINTER 3,5-t Pianale piatto/Telaio (B907, B910)	311 CDI RWD; 314 CDI RWD; 315 CDI RWD; 316 CDI RWD; 317 CDI RWD	feb-18	In produzione	9	AB6088AT	-	MB 236.16
MERCEDES-BENZ	SPRINTER 3,5-t Pianale piatto/Telaio (B907, B910)	311 CDI RWD; 314 CDI RWD; 316 CDI RWD; 316 CDI AWD; 319 CDI RWD; 319 CDI AWD	feb-18	In produzione	7	AB6083AT	-	MB 236.21
MERCEDES-BENZ	SPRINTER 3,5-t Pianale piatto/Telaio (B907, B910)	311 CDI; 311 CDI RWD; 314 CDI; 314 CDI RWD; 314 CDI AWD; 316 CDI RWD; 316 CDI AWD; 317 CDI; 319 CDI RWD; 319 CDI AWD	feb-18	In produzione	7	AB6082AT	-	MB 236.21
MERCEDES-BENZ	SPRINTER 3,5-t Tourer Bus (B907)	311 CDI; 314 CDI; 314 CDI AWD; 316 CDI; 316 CDI AWD; 319 CDI; 319 CDI AWD	feb-18	In produzione	7	AB6082AT	-	MB 236.21
MERCEDES-BENZ	SPRINTER 3,5-t Tourer Bus (B907)	311 CDI; 314 CDI; 315 CDI; 316 CDI; 316 CDI AWD; 317 CDI; 319 CDI; 319 CDI AWD	feb-18	In produzione	7	AB6083AT	-	MB 236.21
MERCEDES-BENZ	SPRINTER 3,5-t Tourer Bus (B907)	311 CDI; 314 CDI; 315 CDI; 316 CDI; 317 CDI	feb-18	In produzione	9	AB6088AT	-	MB 236.16
MERCEDES-BENZ	SPRINTER 3-t Autobus (B903)	308 CDI; 308 D; 308 E; 310 D; 310 D 4x4; 311 CDI; 311 CDI 4x4; 312 D 2.9; 312 D 2.9 4x4; 313 CDI; 313 CDI 4x4; 314; 314 4x4; 314 NGT; 316 CDI; 316 CDI 4x4	feb-95	mag-06	5	AB6078AT	-	MB 236.14
MERCEDES-BENZ	SPRINTER 3-t Autobus (B906)	209 CDI; 210 CDI; 211 CDI; 213 CDI; 214 CDI; 215 CDI; 216; 216 CDI; 218 CDI; 224	giu-06	dic-19	5	AB6078AT	-	MB 236.14
MERCEDES-BENZ	SPRINTER 3-t Autobus (B906)	209 CDI; 210 CDI; 211 CDI; 213 CDI; 214 CDI; 215 CDI; 216; 216 CDI; 218 CDI; 224	giu-06	dic-19	7	AB6082AT	-	MB 236.21
MERCEDES-BENZ	SPRINTER 3-t Autobus (B906)	209 CDI; 210 CDI; 213 CDI; 216; 216 CDI; 218 CDI; 224	giu-06	dic-19	7	AB6177AT	-	MB 236.15
MERCEDES-BENZ	SPRINTER 3-t Autobus (B906)	210 CDI; 211 CDI; 213 CDI; 214 CDI; 215 CDI; 216; 216 CDI; 224	giu-06	dic-18	7	AB6083AT	-	MB 236.21
MERCEDES-BENZ	SPRINTER 3-t Autobus (B906)	210 CDI; 211 CDI; 213 CDI; 214 CDI; 215 CDI; 216; 216 CDI; 224	giu-06	dic-18	7	AB6084AT	-	MB 236.21
MERCEDES-BENZ	SPRINTER 3-t Furgone (B903)	308 CDI; 308 D 2.3; 308 E; 310 D 2.9; 310 D 2.9 4x4; 311 CDI; 311 CDI 4x4; 312 D 2.9; 312 D 2.9 4x4; 313 CDI; 313 CDI 4x4; 314; 314 4x4; 314 NGT; 316 CDI; 316 CDI 4x4	feb-95	mag-06	5	AB6078AT	-	MB 236.14
MERCEDES-BENZ	SPRINTER 3-t Furgone (B906)	219 CDI; 209 CDI; 210 CDI; 211 CDI; 213 CDI; 214 CDI; 215 CDI; 216 CDI; 218 CDI; 224	giu-06	dic-18	7	AB6083AT	-	MB 236.21
MERCEDES-BENZ	SPRINTER 3-t Furgone (B906)	219 CDI; 209 CDI; 210 CDI; 211 CDI; 213 CDI; 214 CDI; 215 CDI; 216 CDI; 218 CDI; 224	giu-06	dic-18	7	AB6084AT	-	MB 236.21
MERCEDES-BENZ	SPRINTER 3-t Furgone (B906)	219 CDI; 209 CDI; 210 CDI; 211 CDI; 213 CDI; 214 CDI; 215 CDI; 216; 216 CDI; 218 CDI; 224	giu-06	dic-18	5	AB6078AT	-	MB 236.14
MERCEDES-BENZ	SPRINTER 3-t Furgone (B906)	219 CDI; 209 CDI; 210 CDI; 211 CDI; 213 CDI; 214 CDI; 215 CDI; 216; 216 CDI; 218 CDI; 224	giu-06	dic-18	7	AB6082AT	-	MB 236.21
MERCEDES-BENZ	SPRINTER 3-t Furgone (B906)	219 CDI; 210 CDI; 213 CDI; 216; 216 CDI; 224	giu-06	dic-18	7	AB6177AT	-	MB 236.15
MERCEDES-BENZ	SPRINTER 3-t Furgone (B910)	211 CDI; 214 CDI	feb-18	In produzione	7	AB6082AT	-	MB 236.21

Marca / Brand:	Modello / Model:	Versioni / Version:	Da anno / From:	Ad anno / To:	Marce / Gears:	Codice AB PARTS		Lubrificante Consigliato
MERCEDES-BENZ	SPRINTER 3-t Pianale piatto/Telaio (B903)	308 CDI; 308 D 2.3; 308 E; 310 D 2.9; 310 D 2.9 4x4; 311 CDI; 311 CDI 4x4; 312 D 2.9; 312 D 2.9 4x4; 313 CDI; 313 CDI 4x4; 314; 314 4x4; 314 NGT; 316 CDI; 316 CDI 4x4	feb-95	mag-06	5	AB6078AT	-	MB 236.14
MERCEDES-BENZ	SPRINTER 3-t Pianale piatto/Telaio (B906)	219 CDI; 209 CDI; 210 CDI; 211 CDI; 213 CDI; 214 CDI; 215 CDI; 216; 216 CDI; 218 CDI; 224	giu-06	dic-18	5	AB6078AT	-	MB 236.14
MERCEDES-BENZ	SPRINTER 3-t Pianale piatto/Telaio (B906)	219 CDI; 209 CDI; 210 CDI; 211 CDI; 213 CDI; 214 CDI; 215 CDI; 216; 216 CDI; 218 CDI; 224	giu-06	dic-18	7	AB6082AT	-	MB 236.21
MERCEDES-BENZ	SPRINTER 3-t Pianale piatto/Telaio (B906)	219 CDI; 209 CDI; 210 CDI; 211 CDI; 213 CDI; 214 CDI; 215 CDI; 216; 216 CDI; 218 CDI; 224	giu-06	dic-18	7	AB6083AT	-	MB 236.21
MERCEDES-BENZ	SPRINTER 3-t Pianale piatto/Telaio (B906)	219 CDI; 209 CDI; 210 CDI; 211 CDI; 213 CDI; 214 CDI; 215 CDI; 216; 216 CDI; 218 CDI; 224	giu-06	dic-18	7	AB6084AT	-	MB 236.21
MERCEDES-BENZ	SPRINTER 3-t Pianale piatto/Telaio (B906)	219 CDI; 210 CDI; 213 CDI; 216; 216 CDI; 224	giu-06	dic-18	7	AB6177AT	-	MB 236.15
MERCEDES-BENZ	SPRINTER 3-t Pianale piatto/Telaio (B910, B907)	211 CDI RWD	giu-20	In produzione	9	AB6088AT	-	MB 236.16
MERCEDES-BENZ	SPRINTER 3-t Pianale piatto/Telaio (B910, B907)	211 CDI RWD; 214 CDI RWD; 215 CDI RWD; 216 CDI RWD; 217 CDI RWD	feb-18	In produzione	7	AB6083AT	-	MB 236.21
MERCEDES-BENZ	SPRINTER 3-t Pianale piatto/Telaio (B910, B907)	211 CDI RWD; 214 CDI RWD; 216 CDI RWD	feb-18	In produzione	7	AB6084AT	-	MB 236.21
MERCEDES-BENZ	SPRINTER 3-t Pianale piatto/Telaio (B910, B907)	211 CDI; 211 CDI RWD; 214 CDI; 214 CDI RWD; 216 CDI RWD	feb-18	In produzione	7	AB6082AT	-	MB 236.21
MERCEDES-BENZ	SPRINTER 3-t Tourer Bus (B907)	211 CDI; 214 CDI; 215 CDI; 216 CDI; 217 CDI	feb-18	In produzione	9	AB6088AT	-	MB 236.16
MERCEDES-BENZ	SPRINTER 3-t Tourer Bus (B907)	211 CDI; 214 CDI; 215 CDI; 216 CDI; 217 CDI	feb-18	In produzione	7	AB6083AT	-	MB 236.21
MERCEDES-BENZ	SPRINTER 3-t Tourer Bus (B907)	211 CDI; 214 CDI; 216 CDI	feb-18	In produzione	7	AB6082AT	-	MB 236.21
MERCEDES-BENZ	SPRINTER 4,6-t Furgone (B906)	411 CDI; 413 CDI; 414 CDI; 414 CDI 4x4; 415 CDI; 416 CDI; 416 CDI 4x4; 418 CDI; 419 CDI; 424	giu-06	dic-18	5	AB6078AT	-	MB 236.14
MERCEDES-BENZ	SPRINTER 4,6-t Furgone (B906)	411 CDI; 413 CDI; 414 CDI; 414 CDI 4x4; 415 CDI; 416 CDI; 416 CDI 4x4; 418 CDI; 419 CDI; 424	giu-06	dic-18	7	AB6082AT	-	MB 236.21
MERCEDES-BENZ	SPRINTER 4,6-t Furgone (B906)	411 CDI; 413 CDI; 414 CDI; 414 CDI 4x4; 415 CDI; 416 CDI; 416 CDI 4x4; 418 CDI; 419 CDI; 424	giu-06	dic-18	7	AB6084AT	-	MB 236.21
MERCEDES-BENZ	SPRINTER 4,6-t Furgone (B906)	411 CDI; 413 CDI; 414 CDI; 415 CDI; 416 CDI; 416 CDI 4x4; 418 CDI; 419 CDI; 424	giu-06	dic-18	7	AB6083AT	-	MB 236.21
MERCEDES-BENZ	SPRINTER 4,6-t Furgone (B906)	411 CDI; 413 CDI; 416 CDI; 416 CDI 4x4; 419 CDI; 424	giu-06	dic-18	7	AB6177AT	-	MB 236.15
MERCEDES-BENZ	SPRINTER 4,6-t Pianale piatto/Telaio (B906)	411 CDI; 413 CDI; 414 CDI; 415 CDI; 416 CDI; 418 CDI; 419 CDI; 424	giu-06	dic-18	5	AB6078AT	-	MB 236.14
MERCEDES-BENZ	SPRINTER 4,6-t Pianale piatto/Telaio (B906)	411 CDI; 413 CDI; 414 CDI; 415 CDI; 416 CDI; 418 CDI; 419 CDI; 424	giu-06	dic-18	7	AB6082AT	-	MB 236.21
MERCEDES-BENZ	SPRINTER 4,6-t Pianale piatto/Telaio (B906)	411 CDI; 413 CDI; 414 CDI; 415 CDI; 416 CDI; 418 CDI; 419 CDI; 424	giu-06	dic-18	7	AB6083AT	-	MB 236.21
MERCEDES-BENZ	SPRINTER 4,6-t Pianale piatto/Telaio (B906)	411 CDI; 413 CDI; 414 CDI; 415 CDI; 416 CDI; 418 CDI; 419 CDI; 424	giu-06	dic-18	7	AB6084AT	-	MB 236.21
MERCEDES-BENZ	SPRINTER 4,6-t Pianale piatto/Telaio (B906)	411 CDI; 413 CDI; 416 CDI; 419 CDI; 424	giu-06	dic-18	7	AB6177AT	-	MB 236.15
MERCEDES-BENZ	SPRINTER 4-t Autobus (B904)	408 CDI; 411 CDI; 413 CDI; 414; 416 CDI	feb-96	mag-06	5	AB6078AT	-	MB 236.14
MERCEDES-BENZ	SPRINTER 4-t Furgone (B904)	408 CDI; 408 D; 410 D; 410 D 4x4; 411 CDI; 411 CDI 4x4; 412 D; 412 D 4x4; 413 CDI; 413 CDI 4x4; 414; 414 4x4; 414 NGT; 416 CDI; 416 CDI 4x4	feb-95	mag-06	5	AB6078AT	-	MB 236.14
MERCEDES-BENZ	SPRINTER 4-t Furgone (B907, B910)	411 CDI RWD; 414 CDI RWD; 414 CDI AWD; 415 CDI RWD; 416 CDI RWD; 416 CDI AWD; 417 CDI RWD; 419 CDI RWD; 419 CDI AWD	feb-18	In produzione	9	AB6088AT	-	MB 236.16
MERCEDES-BENZ	SPRINTER 4-t Furgone (B907, B910)	411 CDI RWD; 414 CDI RWD; 415 CDI RWD; 416 CDI RWD; 416 CDI AWD; 417 CDI RWD; 419 CDI RWD; 419 CDI AWD	feb-18	In produzione	7	AB6083AT	-	MB 236.21
MERCEDES-BENZ	SPRINTER 4-t Furgone (B907, B910)	411 CDI; 411 CDI RWD; 414 CDI; 414 CDI RWD; 414 CDI AWD; 416 CDI RWD; 416 CDI AWD; 419 CDI RWD; 419 CDI AWD	feb-18	In produzione	7	AB6082AT	-	MB 236.21
MERCEDES-BENZ	SPRINTER 4-t Pianale piatto/Telaio (B904)	408 CDI; 408 D; 410 D; 410 D 4x4; 411 CDI; 411 CDI 4x4; 412 D; 412 D 4x4; 413 CDI; 413 CDI 4x4; 414; 414 4x4; 414 NGT; 416 CDI; 416 CDI 4x4	feb-95	mag-06	5	AB6078AT	-	MB 236.14
MERCEDES-BENZ	SPRINTER 4-t Pianale piatto/Telaio (B907, B910)	411 CDI	feb-18	In produzione	5	AB6078AT	-	MB 236.14

Marca / Brand:	Modello / Model:	Versioni / Version:	Da anno / From:	Ad anno / To:	Marce / Gears:	Codice AB PARTS		Lubrificante Consigliato
MERCEDES-BENZ	SPRINTER 4-t Pianale piatto/Telaio (B907, B910)	411 CDI RWD; 414 CDI RWD; 414 CDI AWD; 416 CDI RWD; 416 CDI AWD; 419 CDI RWD; 419 CDI AWD	feb-18	In produzione	7	AB6084AT	-	MB 236.21
MERCEDES-BENZ	SPRINTER 4-t Pianale piatto/Telaio (B907, B910)	411 CDI RWD; 414 CDI RWD; 415 CDI RWD; 416 CDI RWD; 416 CDI AWD; 417 CDI RWD; 419 CDI RWD; 419 CDI AWD	feb-18	In produzione	7	AB6083AT	-	MB 236.21
MERCEDES-BENZ	SPRINTER 4-t Pianale piatto/Telaio (B907, B910)	411 CDI RWD; 414 CDI RWD; 415 CDI RWD; 416 CDI RWD; 417 CDI RWD	feb-18	In produzione	9	AB6088AT	-	MB 236.16
MERCEDES-BENZ	SPRINTER 4-t Pianale piatto/Telaio (B907, B910)	411 CDI; 411 CDI RWD; 414 CDI; 414 CDI RWD; 414 CDI AWD; 416 CDI RWD; 416 CDI AWD; 419 CDI RWD; 419 CDI AWD	feb-18	In produzione	7	AB6082AT	-	MB 236.21
MERCEDES-BENZ	SPRINTER 4-t Tourer Bus (B907)	411 CDI	feb-18	In produzione	7	AB6082AT	-	MB 236.21
MERCEDES-BENZ	SPRINTER 4-t Tourer Bus (B907)	411 CDI; 414 CDI; 417 CDI	feb-18	In produzione	9	AB6088AT	-	MB 236.16
MERCEDES-BENZ	SPRINTER 4-t Tourer Bus (B907)	414 CDI; 417 CDI; 419 CDI	feb-18	In produzione	7	AB6083AT	-	MB 236.21
MERCEDES-BENZ	SPRINTER 5-t Autobus (B906)	513 CDI; 516 CDI; 519 CDI	mar-09	dic-18	5	AB6078AT	-	MB 236.14
MERCEDES-BENZ	SPRINTER 5-t Autobus (B906)	513 CDI; 516 CDI; 519 CDI	mar-09	dic-18	7	AB6082AT	-	MB 236.21
MERCEDES-BENZ	SPRINTER 5-t Autobus (B906)	513 CDI; 516 CDI; 519 CDI	mar-09	dic-18	7	AB6177AT	-	MB 236.15
MERCEDES-BENZ	SPRINTER 5-t Furgone (B906)	519 CDI; 519 CDI 4x4; 509 CDI; 510 CDI; 511 CDI; 511 CDI 4x4; 513 CDI; 513 CDI 4x4; 514 CDI; 514 CDI 4x4; 515 CDI; 515 CDI 4x4; 516 CDI; 516 CDI 4x4; 518 CDI; 518 CDI 4x4; 524	giu-06	dic-18	7	AB6084AT	-	MB 236.21
MERCEDES-BENZ	SPRINTER 5-t Furgone (B906)	519 CDI; 519 CDI 4x4; 509 CDI; 510 CDI; 511 CDI; 511 CDI 4x4; 513 CDI; 513 CDI 4x4; 514 CDI; 514 CDI 4x4; 515 CDI; 515 CDI 4x4; 516 CDI; 516 CDI 4x4; 518 CDI; 518 CDI 4x4; 524	giu-06	dic-18	7	AB6083AT	-	MB 236.21
MERCEDES-BENZ	SPRINTER 5-t Furgone (B906)	519 CDI; 519 CDI 4x4; 516; 509 CDI; 510 CDI; 511 CDI; 511 CDI 4x4; 513 CDI; 513 CDI 4x4; 514 CDI; 514 CDI 4x4; 515 CDI; 515 CDI 4x4; 516 CDI; 516 CDI 4x4; 516 NGT; 518 CDI; 518 CDI 4x4; 524	giu-06	dic-18	5	AB6078AT	-	MB 236.14
MERCEDES-BENZ	SPRINTER 5-t Furgone (B906)	519 CDI; 519 CDI 4x4; 516; 509 CDI; 510 CDI; 511 CDI; 511 CDI 4x4; 513 CDI; 513 CDI 4x4; 514 CDI; 514 CDI 4x4; 515 CDI; 515 CDI 4x4; 516 CDI; 516 CDI 4x4; 518 CDI; 518 CDI 4x4; 524	giu-06	dic-18	7	AB6082AT	-	MB 236.21
MERCEDES-BENZ	SPRINTER 5-t Furgone (B906)	519 CDI; 519 CDI 4x4; 516; 510 CDI; 513 CDI; 513 CDI 4x4; 516 CDI; 516 CDI 4x4; 516 NGT; 524	giu-06	dic-18	7	AB6177AT	-	MB 236.15
MERCEDES-BENZ	SPRINTER 5-t Furgone (B907)	511 CDI; 514 CDI; 516 CDI; 516 CDI AWD; 519 CDI; 519 CDI AWD	feb-18	In produzione	7	AB6082AT	-	MB 236.21
MERCEDES-BENZ	SPRINTER 5-t Furgone (B907)	514 CDI; 515 CDI; 516 CDI; 516 CDI AWD; 517 CDI; 519 CDI; 519 CDI AWD	feb-18	In produzione	7	AB6083AT	-	MB 236.21
MERCEDES-BENZ	SPRINTER 5-t Pianale piatto/Telaio (B905)	616 CDI	apr-01	mag-06	5	AB6078AT	-	MB 236.14
MERCEDES-BENZ	SPRINTER 5-t Pianale piatto/Telaio (B906)	519 CDI; 519 CDI 4x4; 509 CDI; 510 CDI; 511 CDI; 511 CDI 4x4; 513 CDI; 513 CDI 4x4; 514 CDI; 514 CDI 4x4; 515 CDI; 515 CDI 4x4; 516; 516 CDI; 516 CDI 4x4; 516 NGT; 518 CDI; 518 CDI 4x4; 524	giu-06	dic-18	5	AB6078AT	-	MB 236.14
MERCEDES-BENZ	SPRINTER 5-t Pianale piatto/Telaio (B906)	519 CDI; 519 CDI 4x4; 509 CDI; 510 CDI; 511 CDI; 511 CDI 4x4; 513 CDI; 513 CDI 4x4; 514 CDI; 514 CDI 4x4; 515 CDI; 515 CDI 4x4; 516; 516 CDI; 516 CDI 4x4; 516 NGT; 518 CDI; 518 CDI 4x4; 524	giu-06	dic-18	7	AB6082AT	-	MB 236.21
MERCEDES-BENZ	SPRINTER 5-t Pianale piatto/Telaio (B906)	519 CDI; 519 CDI 4x4; 509 CDI; 510 CDI; 511 CDI; 511 CDI 4x4; 513 CDI; 513 CDI 4x4; 514 CDI; 514 CDI 4x4; 515 CDI; 515 CDI 4x4; 516; 516 CDI; 516 CDI 4x4; 516 NGT; 518 CDI; 518 CDI 4x4; 524	giu-06	dic-18	7	AB6083AT	-	MB 236.21
MERCEDES-BENZ	SPRINTER 5-t Pianale piatto/Telaio (B906)	519 CDI; 519 CDI 4x4; 509 CDI; 510 CDI; 511 CDI; 511 CDI 4x4; 513 CDI; 513 CDI 4x4; 514 CDI; 514 CDI 4x4; 515 CDI; 515 CDI 4x4; 516; 516 CDI; 516 CDI 4x4; 516 NGT; 518 CDI; 518 CDI 4x4; 524	giu-06	dic-18	7	AB6084AT	-	MB 236.21
MERCEDES-BENZ	SPRINTER 5-t Pianale piatto/Telaio (B906)	519 CDI; 519 CDI 4x4; 510 CDI; 513 CDI; 513 CDI 4x4; 516; 516 CDI; 516 CDI 4x4; 516 NGT; 524	giu-06	dic-18	7	AB6177AT	-	MB 236.15
MERCEDES-BENZ	SPRINTER 5-t Pianale piatto/Telaio (B907)	511 CDI; 514 CDI; 515 CDI RWD; 516 CDI; 516 CDI AWD; 517 CDI RWD; 519 CDI; 519 CDI RWD; 519 CDI AWD	feb-18	In produzione	9	AB6088AT	-	MB 236.16
MERCEDES-BENZ	SPRINTER 5-t Pianale piatto/Telaio (B907)	511 CDI; 514 CDI; 516 CDI; 516 CDI AWD; 519 CDI; 519 CDI AWD	feb-18	In produzione	7	AB6082AT	-	MB 236.21
MERCEDES-BENZ	SPRINTER 5-t Pianale piatto/Telaio (B907)	511 CDI; 514 CDI; 516 CDI; 516 CDI AWD; 519 CDI; 519 CDI AWD	feb-18	In produzione	7	AB6084AT	-	MB 236.21
MERCEDES-BENZ	SPRINTER 5-t Pianale piatto/Telaio (B907)	514 CDI; 516 CDI; 516 CDI AWD; 519 CDI; 519 CDI AWD	feb-18	In produzione	7	AB6083AT	-	MB 236.21
MERCEDES-BENZ	VANEO (414)	1.6; 1.7 CDI; 1.9	feb-02	lug-05	5	AB6089AT	-	MB 236.12

Marca / Brand:	Modello / Model:	Versioni / Version:	Da anno / From:	Ad anno / To:	Marce / Gears:	Codice AB PARTS		Lubrificante Consigliato
MERCEDES-BENZ	VIANO (W639)	3.2; 3.5; 3.7; CDI 2.0; CDI 2.0 4-matic; CDI 2.2; CDI 2.2 4-matic; CDI 3.0	set-03	In produzione	5	AB6078AT	-	MB 236.14
MERCEDES-BENZ	VITO / MIXTO Furgone (W639)	109 CDI; 110 CDI; 111 CDI; 111 CDI 4x4; 113 CDI; 113 CDI 4x4; 115 CDI; 115 CDI 4x4; 116 CDI; 116 CDI 4x4; 119; 120 CDI; 122; 122 CDI; 123; 126; E-CELL	set-03	In produzione	5	AB6078AT	-	MB 236.14
MERCEDES-BENZ	VITO Autobus (W639)	109 CDI; 109 CDI 4x4; 110 CDI; 111 CDI; 111 CDI 4x4; 113 CDI; 113 CDI 4x4; 115 CDI; 115 CDI 4x4; 116 CDI; 116 CDI 4x4; 119; 120 CDI; 122; 122 CDI; 123; 126; E-CELL	set-03	In produzione	5	AB6078AT	-	MB 236.14
MERCEDES-BENZ	VITO Furgone (W447)	119 CDI; 119 CDI 4x4; 109 CDI; 110 CDI; 111 CDI; 114 CDI; 114 CDI 4x4; 116 CDI; 116 CDI 4x4	ott-14	In produzione	9	AB6088AT	-	MB 236.16
MERCEDES-BENZ	VITO Furgone (W447)	119 CDI; 119 CDI 4x4; 109 CDI; 111 CDI; 114 CDI; 114 CDI 4x4; 116 CDI; 116 CDI 4x4	ott-14	In produzione	7	AB6082AT	-	MB 236.21
MERCEDES-BENZ	VITO Furgone (W447)	119 CDI; 119 CDI 4x4; 109 CDI; 111 CDI; 114 CDI; 114 CDI 4x4; 116 CDI; 116 CDI 4x4	ott-14	In produzione	7	AB6084AT	-	MB 236.21
MERCEDES-BENZ	VITO Furgone (W447)	119 CDI; 119 CDI 4x4; 114 CDI; 114 CDI 4x4; 116 CDI; 116 CDI 4x4	ott-14	In produzione	7	AB6083AT	-	MB 236.21
MERCEDES-BENZ	VITO Mixto (Double Cabin) (W447)	109 CDI; 110 CDI; 111 CDI; 114 CDI; 114 CDI 4-matic; 116 CDI; 116 CDI 4-matic; 119 BlueTEC; 119 BlueTEC 4-matic; 119 CDI; 119 CDI 4-matic; 124 CDI; 124 CDI 4-matic	ott-14	In produzione	9	AB6088AT	-	MB 236.16
MERCEDES-BENZ	VITO Mixto (Double Cabin) (W447)	109 CDI; 111 CDI; 114 CDI; 114 CDI 4-matic; 116 CDI; 116 CDI 4-matic; 119 BlueTEC; 119 BlueTEC 4-matic; 119 CDI; 119 CDI 4-matic	ott-14	In produzione	7	AB6082AT	-	MB 236.21
MERCEDES-BENZ	VITO Mixto (Double Cabin) (W447)	109 CDI; 111 CDI; 114 CDI; 114 CDI 4-matic; 116 CDI; 116 CDI 4-matic; 119 BlueTEC; 119 BlueTEC 4-matic; 119 CDI; 119 CDI 4-matic	ott-14	In produzione	7	AB6084AT	-	MB 236.21
MERCEDES-BENZ	VITO Mixto (Double Cabin) (W447)	114 CDI; 114 CDI 4-matic; 116 CDI; 116 CDI 4-matic; 119 BlueTEC; 119 BlueTEC 4-matic; 119 CDI; 119 CDI 4-matic	ott-14	In produzione	7	AB6083AT	-	MB 236.21
MERCEDES-BENZ	VITO Tourer (W447)	114 CDI; 116 CDI; 119 CDI; 114 CDI 4x4; 116 CDI 4x4; 119 CDI 4x4; 109 CDI; 111 CDI; 114 CDI; 114 CDI 4-matic; 116 CDI 4-matic; 119 CDI 4-matic	ott-14	In produzione	7	AB6084AT	-	MB 236.21
MERCEDES-BENZ	VITO Tourer (W447)	116 CDI; 119 CDI; 114 CDI 4x4; 116 CDI 4x4; 119 CDI 4x4; 109 CDI; 111 CDI; 114 CDI; 110 CDI; 114 CDI 4-matic; 116 CDI 4-matic; 119 CDI 4-matic; 124 CDI; 124 CDI 4-matic	ott-14	In produzione	9	AB6088AT	-	MB 236.16
MERCEDES-BENZ	VITO Tourer (W447)	116 CDI; 119 CDI; 114 CDI 4x4; 116 CDI 4x4; 119 CDI 4x4; 109 CDI; 111 CDI; 114 CDI; 114 CDI 4-matic; 116 CDI 4-matic; 119 CDI 4-matic	ott-14	In produzione	7	AB6082AT	-	MB 236.21
MERCEDES-BENZ	VITO Tourer (W447)	116 CDI; 119 CDI; 114 CDI 4x4; 116 CDI 4x4; 119 CDI 4x4; 114 CDI; 114 CDI 4-matic; 116 CDI 4-matic; 119 CDI 4-matic	ott-14	In produzione	7	AB6083AT	-	MB 236.21
MINI	MINI (R50, R53)	Cooper; One	giu-01	set-06	CVT	AB6016AT	-	MINI ATF JWS 3309
MINI	MINI (R50, R53)	John Cooper Works	mar-06	set-06	6	AB6005AT	-	VW G055025A2
MINI	MINI (R56)	Cooper; Cooper D; Cooper S; Cooper S John Cooper Works; Cooper SD; John Cooper Works; John Cooper Works GP; One; One D; One LPG	set-06	nov-13	6	AB6005AT	-	VW G055025A2
MINI	MINI Cabriolet (R52)	Cooper	apr-04	lug-08	CVT	AB6016AT	-	MINI ATF JWS 3309
MINI	MINI Cabriolet (R57)	Cooper; Cooper D; Cooper S; Cooper SD; John Cooper Works; One	ott-07	giu-15	6	AB6005AT	-	VW G055025A2
MINI	MINI CLUBMAN (R55)	Cooper; Cooper D; Cooper S; Cooper S John Cooper Works; Cooper SD; John Cooper Works; One; One D	ago-07	giu-14	6	AB6005AT	-	VW G055025A2
MINI	MINI CLUBVAN (R55)	Cooper; Cooper D; One	dic-12	giu-14	6	AB6005AT	-	VW G055025A2
MINI	MINI COUNTRYMAN (R60)	Cooper; Cooper ALL4; Cooper D; Cooper D ALL4; Cooper S; Cooper S ALL4; Cooper SD; Cooper SD ALL4; John Cooper Works ALL4; One; One D	ago-10	ott-16	6	AB6005AT	-	VW G055025A2
MINI	MINI Coupé (R58)	1.6 Cooper; Cooper; Cooper S; Cooper S JCW; Cooper SD; John Cooper Works	dic-10	mag-15	6	AB6005AT	-	VW G055025A2
MINI	MINI PACEMAN (R61)	Cooper; Cooper ALL4; Cooper D; Cooper D ALL4; Cooper S; Cooper S ALL4; Cooper SD; Cooper SD ALL4; John Cooper Works ALL4	mar-12	ott-16	6	AB6005AT	-	VW G055025A2
MINI	MINI Roadster (R59)	Cooper; Cooper S; Cooper S JCW; Cooper SD; John Cooper Works	nov-11	apr-15	6	AB6005AT	-	VW G055025A2

Marca / Brand:	Modello / Model:	Versioni / Version:	Da anno / From :	Ad anno / To:	Marce / Gears:	Codice AB PARTS		Lubrificante Consigliato
MITSUBISHI	CARISMA (DA_)	1.6; 1.8; 1.8 16V GDI; 1.8 GDI; 1.8 MSX - 16V	mag-95	giu-06	4 / 5	AB6092AT	-	Mitsubishi ATF SP-III
MITSUBISHI	CARISMA Tre volumi (DA_)	1.6; 1.8; 1.8 16V GDI; 1.8 GDI	set-96	giu-06	4 / 5	AB6092AT	-	Mitsubishi ATF SP-III
MITSUBISHI	COLT V (CJ_, CP_)	1300; 1300 GL, GLX; 1600; 1600 GLX	mag-96	set-03	4 / 5	AB6092AT	-	Mitsubishi ATF SP-III
MITSUBISHI	GALANT IX Tre volumi (DJ_, ED_, EF_)	2.4	ott-03	In produzione	4 / 5	AB6092AT	-	Mitsubishi ATF SP-III
MITSUBISHI	GALANT VIII (EA_)	2.0; 2.4 GDI; 2.5 V6 24V	set-96	ott-04	4 / 5	AB6092AT	-	Mitsubishi ATF SP-III
MITSUBISHI	GALANT VIII Familiare (EA_, EC_)	2.0; 2.4 GDI; 2.5 V6 24V	set-96	ott-03	4 / 5	AB6092AT	-	Mitsubishi ATF SP-III
MITSUBISHI	GRANDIS (NA_W)	2.4 MIVEC	apr-04	dic-11	4 / 5	AB6092AT	-	Mitsubishi ATF SP-III
MITSUBISHI	L200 (K7_T, K6_T, K5_T)	3.0 4WD	ago-01	nov-05	4 / 5	AB6093AT	-	Mitsubishi ATF SP-III
MITSUBISHI	L200 / TRITON (KA_T, KB_T)	2.5 DI-D; 2.5 DI-D 4WD; 3.5 4WD	nov-05	dic-15	4 / 5	AB6093AT	-	Mitsubishi ATF SP-III
MITSUBISHI	L200 / TRITON (KJ_, KK_, KL_)	2.4 DI-D; 2.4 DI-D 4WD	nov-14	In produzione	5	AB6122AT	-	Toyota ATF WS
MITSUBISHI	L200 / TRITON Pianale piatto/Telaio (KA_T, KB_T)	2.5 DI-D 4WD	set-09	dic-15	4 / 5	AB6093AT	-	Mitsubishi ATF SP-III
MITSUBISHI	LANCER VI (CJ_, CP_)	1.3 12V; 1.6 16V; 1.8 16V	set-95	ago-03	4 / 5	AB6092AT	-	Mitsubishi ATF SP-III
MITSUBISHI	LANCER VII (CS_A, CT_A)	1.6; 2.0	set-03	dic-13	4 / 5	AB6092AT	-	Mitsubishi ATF SP-III
MITSUBISHI	LANCER VII (CS_A, CT_A)	2.0 i	ott-07	dic-13	6	AB6098AT + AB6100AT *	AB6099AT *	FORD 1490763
MITSUBISHI	LANCER VII Familiare (CS_W, CT_W)	1.6; 2.0	set-03	ott-08	4 / 5	AB6092AT	-	Mitsubishi ATF SP-III
MITSUBISHI	LANCER VIII (CY_A, CZ_A)	1.5; 1.5 Bifuel	giu-08	In produzione	4 / 5	AB6092AT	-	Mitsubishi ATF SP-III
MITSUBISHI	LANCER VIII (CY_A, CZ_A)	2.0 EVO X; 2.0 i; 2.0 i 4WD; 2.0 i Ralliart 4WD; EVO X - FQ330; EVO X - FQ360; EVO X - FQ440; EVO X	mar-07	In produzione	6	AB6098AT + AB6100AT *	AB6099AT *	FORD 1490763
MITSUBISHI	LANCER VIII Sportback (CX_A)	1.5; 1.5 Bifuel	giu-08	In produzione	4 / 5	AB6092AT	-	Mitsubishi ATF SP-III
MITSUBISHI	LANCER VIII Sportback (CX_A)	2.0 Ralliart 4WD	ott-08	In produzione	6	AB6098AT + AB6100AT *	AB6099AT *	FORD 1490763
MITSUBISHI	OUTLANDER I (CU_W)	2.0; 2.0 4WD; 2.0 Turbo 4WD; 2.0 Turbo-R 4WD; 2.4 4WD	gen-02	set-07	4 / 5	AB6092AT	-	Mitsubishi ATF SP-III
MITSUBISHI	OUTLANDER II (CW_W)	2.2 DI-D; 2.2 DI-D 4WD	nov-06	nov-12	6	AB6098AT + AB6100AT *	AB6099AT *	FORD 1490763
MITSUBISHI	OUTLANDER II Van (CW_W)	DI-D 4WD	set-10	dic-12	6	AB6098AT + AB6100AT *	AB6099AT *	FORD 1490763
MITSUBISHI	PAJERO II (V3_W)	3.2 DiD 4WD	apr-00	set-07	4 / 5	AB6093AT	-	Mitsubishi ATF SP-III
MITSUBISHI	PAJERO III (V7_W, V6_W)	3.2 DI-D; 3.5	apr-00	gen-07	4 / 5	AB6093AT	-	Mitsubishi ATF SP-III
MITSUBISHI	PAJERO III Canvas Top (V6_W, V7_W)	3.2 DI-D; 3.5 V6 GDI	apr-00	dic-06	4 / 5	AB6093AT	-	Mitsubishi ATF SP-III
MITSUBISHI	PAJERO IV (V8_W, V9_W)	3.0 4WD; 3.2 DI-D; 3.2 DI-D 4WD; 3.8 V6	ott-06	In produzione	4 / 5	AB6093AT	-	Mitsubishi ATF SP-III
MITSUBISHI	PAJERO IV (V8_W, V9_W)	3.2 4WD; 3.2 DI-D; 3.2 DI-D 4WD	feb-07	In produzione	5	AB6122AT	-	Toyota ATF WS
MITSUBISHI	PAJERO IV Van (V9_, V8_, V8_V)	3.2 DI-D 4WD	feb-07	In produzione	4 / 5	AB6093AT	-	Mitsubishi ATF SP-III
MITSUBISHI	PAJERO IV Van (V9_, V8_, V8_V)	3.2 DI-D 4WD; 3.2 TD 4WD	feb-07	In produzione	5	AB6122AT	-	Toyota ATF WS
MITSUBISHI	PAJERO SPORT I (K7_, K9_)	3.0 4WD; 3.0 V6; 3.0 V6 4WD	set-96	In produzione	4 / 5	AB6093AT	-	Mitsubishi ATF SP-III
MITSUBISHI	PAJERO SPORT II (KH_, KG_)	3.0 4WD	set-08	In produzione	4 / 5	AB6093AT	-	Mitsubishi ATF SP-III
MITSUBISHI	PAJERO SPORT III (KS_)	2.4 DI-D 4x4; 3.0 Mivec 4x4	ago-15	In produzione	8	AB6011AT	-	VW G055540A2
MITSUBISHI	SPACE RUNNER (N6_W)	2.0; 2.4 GDI	ago-99	gen-03	4 / 5	AB6092AT	-	Mitsubishi ATF SP-III
MITSUBISHI	SPACE STAR MPV / Space wagon (DG_A)	1.6 16V; 1.8 GDI; 1.8 MPI	giu-98	dic-04	4 / 5	AB6092AT	-	Mitsubishi ATF SP-III
MITSUBISHI	SPACE WAGON (N9_W, N8_W)	2.4 GDI; 2.4 GDI 4WD	ott-98	dic-04	4 / 5	AB6092AT	-	Mitsubishi ATF SP-III

Marca / Brand:	Modello / Model:	Versioni / Version:	Da anno / From:	Ad anno / To:	Marce / Gears:	Codice AB PARTS		Lubrificante Consigliato
NISSAN	ALTIMA (L33)	2.5	mag-12	In produzione	CVT	AB6062AT + AB6063AT	-	NISSAN NS2 o NS3
NISSAN	JUKE (F15)	1.2 DIG-T; 1.6 DIG-T; 1.6 DIG-T 4x4; 1.6 DIG-T NISMO; 1.6 DIG-T NISMO 4x4; 1.6 DIG-T NISMO RS; 1.6 DIG-T NISMO RS 4x4	giu-10	dic-19	CVT	AB6060AT + AB6063AT	-	NISSAN NS2 o NS3
NISSAN	JUKE (F15)	1.6	giu-10	dic-19	CVT	AB6064AT + AB6065AT	-	NISSAN NS2 o NS3
NISSAN	JUKE (F15)	1.6 DIG-T; 1.6 DIG-T NISMO; 1.6 DIG-T NISMO RS	giu-10	dic-19	CVT	AB6062AT + AB6063AT	-	NISSAN NS2 o NS3
NISSAN	JUKE Van (F15)	CVTC	mar-13	dic-19	CVT	AB6064AT + AB6065AT	-	NISSAN NS2 o NS3
NISSAN	MICRA IV (K13K, K13KK)	1.2; 1.2 DIG-S; 1.2 LPG	mag-10	ott-15	CVT	AB6064AT + AB6065AT	-	NISSAN NS2 o NS3
NISSAN	MICRA IV (K13KK)	1.2; 1.2 DIG-S	mar-11	In produzione	CVT	AB6064AT + AB6065AT	-	NISSAN NS2 o NS3
NISSAN	MURANO II (Z51)	3.5 4x4	ott-08	set-14	CVT	AB6061AT + AB6063AT	-	NISSAN NS2 o NS3
NISSAN	MURANO III (Z52_)	3.5 V6; 3.5 V6 ALL MODE 4x4-i	gen-16	In produzione	CVT	AB6064AT + AB6068AT	-	NISSAN NS3 CVT
NISSAN	PATHFINDER IV (R52)	3.5 4WD	ago-14	In produzione	CVT	AB6064AT + AB6068AT	-	NISSAN NS3 CVT
NISSAN	QASHQAI / QASHQAI +2 I (J10, NJ10, JJ10E)	1.6	feb-07	dic-13	CVT	AB6064AT + AB6065AT	-	NISSAN NS2 o NS3
NISSAN	QASHQAI / QASHQAI +2 I (J10, NJ10, JJ10E)	1.6 dCi AWD; 2.0; 2.0 dCi AWD; 2.0 AWD	feb-07	dic-13	CVT	AB6061AT + AB6063AT	-	NISSAN NS2 o NS3
NISSAN	QASHQAI / QASHQAI +2 I VAN (J10, JJ10E)	1.6 CVTC	mar-13	apr-14	CVT	AB6064AT + AB6065AT	-	NISSAN NS2 o NS3
NISSAN	QASHQAI II SUV (J11, J11_)	1.6 dCi	nov-13	In produzione	CVT	AB6064AT + AB6068AT	-	NISSAN NS3 CVT
NISSAN	QASHQAI II SUV (J11, J11_)	2.0 (J11E); 2.0 ALL MODE 4x4-i (J11R)	giu-14	In produzione	CVT	AB6062AT + AB6063AT	-	NISSAN NS2 o NS3
NISSAN	TEANA II (J32)	2.5	mar-10	gen-13	CVT	AB6061AT + AB6063AT	-	NISSAN NS2 o NS3
NISSAN	TEANA II (J32)	2.5; 2.5 FOUR 4x4; 2.5	lug-08	set-13	CVT	AB6062AT + AB6063AT	-	NISSAN NS2 o NS3
NISSAN	X-TRAIL II (T31)	2.0 4x4; 2.0 FWD; 2.5 4x4	giu-07	nov-13	CVT	AB6061AT + AB6063AT	-	NISSAN NS2 o NS3
NISSAN	X-TRAIL III (T32_, T32R, T32RR)	1.6 dCi	apr-14	In produzione	CVT	AB6064AT + AB6068AT	-	NISSAN NS3 CVT
NISSAN	X-TRAIL III (T32_, T32R, T32RR)	1.6 dCi; 1.6 dCi ALL MODE 4x4-i; 1.7 dCi; 1.7 dCi ALL MODE 4x4-i; 2.0 dCi; 2.0 dCi ALL MODE 4x4-i	apr-14	In produzione	CVT	AB6064AT + AB6066AT	-	NISSAN NS3 CVT

Marca / Brand:	Modello / Model:	Versioni / Version:	Da anno / From:	Ad anno / To:	Marce / Gears:	Codice AB PARTS		Lubrificante Consigliato
NISSAN	X-TRAIL III (T32_, T32R, T32RR)	2.0 (T32); 2.0 ALL MODE 4x4-i (NT32); 2.5 ALL MODE 4x4-i (NT32)	dic-13	In produzione	CVT	AB6062AT + AB6063AT	-	NISSAN NS2 o NS3
NISSAN	X-TRAIL III (T32_, T32R, T32RR)	2.0; 2.0 ALL MODE 4x4-i; 2.5 ALL MODE 4x4-i	dic-13	In produzione	CVT	AB6061AT + AB6063AT	-	NISSAN NS2 o NS3
NISSAN	X-TRAIL VAN (T32)	dCi	apr-14	In produzione	CVT	AB6064AT + AB6068AT	-	NISSAN NS3 CVT
NISSAN	X-TRAIL VAN (T32)	dCi; dCi 4x4	apr-14	In produzione	CVT	AB6064AT + AB6066AT	-	MITSUBISHI CVTF-J4
OPEL	ANTARA A (L07)	2.0 CDTI; 2.0 CDTI 4x4; 2.2 CDTI; 2.2 CDTI 4x4; 2.4; 2.4 4x4; 2.4 LPG; 2.4 LPG 4x4; 3.0; 3.2 V6	ago-06	ago-17	6	AB6052AT	-	DEXRON VI
OPEL	ASTRA (B16)	1.4 TURBO; ST 1.4 TURBO S&S	lug-18	gen-20	6	AB6050AT	-	DEXRON VI
OPEL	ASTRA F Cabriolet (T92)	1.4 i 16V; 1.4 Si; 1.6 i; 1.8 i 16V; 2.0 i	mar-93	mar-01	4	AB6004AT	-	DEXRON II
OPEL	ASTRA F CLASSIC Familiare (T92)	1.6 i 16V	gen-98	gen-05	4	AB6004AT	-	DEXRON II
OPEL	ASTRA F Familiare (T92)	1.4 i; 1.4 i 16V; 1.4 Si; 1.6 i; 1.6 i 16V; 1.6 Si; 1.7 D; 1.7 TD; 1.7 TDS; 1.8; 1.8 i; 1.8 i 16V; 2.0 i; 2.0 i 16V	set-91	gen-98	4	AB6004AT	-	DEXRON II
OPEL	ASTRA F Furgone/familiare (T92)	1.4 i; 1.6 i; 1.7 D; 1.7 TD	ott-91	gen-99	4	AB6004AT	-	DEXRON II
OPEL	ASTRA F Hatchback (T92)	1.4 i; 1.4 i 16V; 1.4 Si; 1.6 i; 1.6 i; 1.6 i 16V; 1.6 Si; 1.7 D; 1.7 TD; 1.7 TDS; 1.8; 1.8 i; 1.8 i 16V; 2.0 GSI 16V; 2.0 i; 2.0 i 16V	set-91	feb-98	4	AB6004AT	-	DEXRON II
OPEL	ASTRA F Tre volumi (T92)	1.4; 1.4 i; 1.4 i 16V; 1.4 Si; 1.6 i; 1.6 i 16V; 1.6 Si; 1.7 D; 1.7 TD; 1.7 TDS; 1.8 i; 1.8 i 16V; 2.0 i; 2.0 i 16V	set-91	set-98	4	AB6004AT	-	DEXRON II
OPEL	ASTRA G Cabriolet (T98)	1.6; 1.6 16V; 1.8 16V; 2.0 16V Turbo; 2.0 OPC; 2.2 16V; 2.2 DTI	mar-01	ott-05	4	AB6004AT	-	DEXRON II
OPEL	ASTRA G CLASSIC (T98)	1.7 CDTI	giu-04	lug-09	4	AB6004AT	-	DEXRON II
OPEL	ASTRA G CLASSIC Caravan (F35)	1.4; 1.4 16V; 1.6; 1.7 CDTI	mag-04	lug-09	4	AB6004AT	-	DEXRON II
OPEL	ASTRA G CLASSIC Tre volumi (T98)	1.4 16V; 1.6 16V	mar-04	lug-09	4	AB6004AT	-	DEXRON II
OPEL	ASTRA G Coupé (T98)	1.6 16V; 1.8 16V; 2.0 16V Turbo; 2.2 16V; 2.2 DTI	mar-00	mag-05	4	AB6004AT	-	DEXRON II
OPEL	ASTRA G Familiare (T98)	1.2 16V; 1.4 16V; 1.4 LPG; 1.6; 1.6 16V; 1.6 LPG; 1.7 CDTI; 1.7 DTI 16V; 1.7 TD; 1.8 16V; 2.0 16V; 2.0 Di; 2.0 DTI 16V; 2.0 OPC; 2.2 16V; 2.2 DTI	feb-98	lug-04	4	AB6004AT	-	DEXRON II
OPEL	ASTRA G Furgone/familiare (F70)	1.4; 1.6; 1.7 TD; 2.0 Di; 2.0 DTI	set-98	apr-05	4	AB6004AT	-	DEXRON II
OPEL	ASTRA G Hatchback (T98)	1.2 16V; 1.4; 1.4 16V; 1.4 LPG; 1.6; 1.6 16V; 1.6 LPG; 1.7 CDTI; 1.7 DTI 16V; 1.7 TD; 1.8 16V; 2.0 16V; 2.0 16V OPC; 2.0 Di; 2.0 DTI 16V; 2.0 OPC; 2.2 16V; 2.2 DTI	feb-98	dic-09	4	AB6004AT	-	DEXRON II
OPEL	ASTRA G Tre volumi (T98)	1.2 16V; 1.4; 1.4 16V; 1.4 LPG; 1.6; 1.6 16V; 1.6 LPG; 1.7 CDTI; 1.7 DTI 16V; 1.7 TD; 1.8 16V; 2.0 16V; 2.0 Di; 2.0 DTI 16V; 2.2 16V; 2.2 DTI	mar-98	dic-09	4	AB6004AT	-	DEXRON II
OPEL	ASTRA H (A04)	1.2; 1.3 CDTI; 1.4; 1.6; 1.6 Turbo; 1.7 CDTI; 1.8; 1.9 CDTI; 1.9 CDTI 16V; 2.0 Turbo	gen-04	mag-14	4	AB6004AT	-	DEXRON II
OPEL	ASTRA H CLASSIC Familiare (A04)	1.6	dic-06	mag-14	4	AB6004AT	-	DEXRON II
OPEL	ASTRA H CLASSIC Hatchback (A04)	1.6	gen-09	In produzione	4	AB6004AT	-	DEXRON II
OPEL	ASTRA H CLASSIC Tre volumi (A04)	1.6	gen-09	mag-14	4	AB6004AT	-	DEXRON II
OPEL	ASTRA H Familiare (A04)	1.3 CDTI; 1.4; 1.6; 1.6 LPG; 1.6 Turbo; 1.7 CDTI; 1.8; 1.9 CDTI; 1.9 CDTI 16V; 2.0 Turbo	ago-04	mag-14	4	AB6004AT	-	DEXRON II
OPEL	ASTRA H Furgone/familiare (L70)	1.3 CDTI; 1.6 EcoTec; 1.7 CDTI; 1.9 CDTI; 1.9 CDTI 16V	mar-04	ott-14	4	AB6004AT	-	DEXRON II
OPEL	ASTRA H GTC (A04)	1.3 CDTI; 1.4; 1.6; 1.6 Turbo; 1.7 CDTI; 1.8; 1.9 CDTI; 1.9 CDTI 16V; 2.0 Turbo	mar-05	ott-10	4	AB6004AT	-	DEXRON II
OPEL	ASTRA H Tre volumi (A04)	1.6; 1.7 CDTI; 1.8	feb-07	mag-14	4	AB6004AT	-	DEXRON II
OPEL	ASTRA H TwinTop (A04)	1.6; 1.6 Turbo; 1.8; 1.9 CDTI; 2.0 Turbo	set-05	ott-10	4	AB6004AT	-	DEXRON II

Marca / Brand:	Modello / Model:	Versioni / Version:	Da anno / From:	Ad anno / To:	Marce / Gears:	Codice AB PARTS		Lubrificante Consigliato
OPEL	ASTRA K (B16)	1.0 Turbo; 1.2 Turbo; 1.4; 1.4 CNG; 1.4 Turbo; 1.5 CRDI; 1.6 BiTurbo; 1.6 CDTi; 1.6 Turbo	giu-15	dic-22	8 / 9	AB6039AT + AB6040AT	-	DEXRON HP
OPEL	ASTRA K (B16)	1.4 Turbo	ago-19	dic-22	CVT	AB6053AT + AB6054AT	-	OPEL 95529854
OPEL	ASTRA K Furgone/familiare	1.0; 1.4; 1.5 CRDI	mag-18	In produzione	8 / 9	AB6039AT + AB6040AT	-	DEXRON HP
OPEL	ASTRA K Furgone/hatchback	1.6 CDTi	apr-18	In produzione	8 / 9	AB6039AT + AB6040AT	-	DEXRON HP
OPEL	ASTRA K Sports Tourer (B16)	1.0 Turbo; 1.2 Turbo; 1.4; 1.4 CNG; 1.4 Turbo; 1.5 CRDI; 1.6 BiTurbo; 1.6 CDTi; 1.6 Turbo	nov-15	dic-22	8 / 9	AB6039AT + AB6040AT	-	DEXRON HP
OPEL	ASTRA K Sports Tourer (B16)	1.4 Turbo	ago-19	dic-22	CVT	AB6053AT + AB6054AT	-	OPEL 95529854
OPEL	COMBO Cassone/Limousine spaziosa	1.3 CDTi 16V; 1.4 16V; 1.6; 1.6 CNG 16V; 1.7 CDTi 16V; 1.7 DI 16V; 1.7 DTi 16V	ott-01	In produzione	4	AB6004AT	-	DEXRON II
OPEL	COMBO Cassone/Limousine spaziosa (71_)	1.2; 1.4; 1.4 16V; 1.7 D	lug-94	ott-01	4	AB6004AT	-	DEXRON II
OPEL	COMBO Tour	1.3 CDTi 16V; 1.4; 1.6; 1.6 CNG; 1.7 DI 16V; 1.7 DTi 16V	ott-01	dic-11	4	AB6004AT	-	DEXRON II
OPEL	CORSA B (S93)	1.0 i 12V; 1.2 i; 1.2 i 16V; 1.4 i; 1.4 i 16V; 1.4 Si; 1.5 D; 1.5 TD; 1.6 GSi 16V; 1.6 i 16V; 1.7 D	mar-93	set-00	4	AB6004AT	-	DEXRON II
OPEL	CORSA B Furgone/hatchback (S93)	1.4 i; 1.7 D	ago-99	set-00	4	AB6004AT	-	DEXRON II
OPEL	CORSA B STATION WAGON (S93)	1.4 i 16V	gen-99	dic-02	4	AB6004AT	-	DEXRON II
OPEL	CORSA C (X01)	1.0; 1.2; 1.2 Twinport; 1.3 CDTi; 1.4; 1.4 Twinport; 1.7 CDTi; 1.7 DI; 1.7 DTi; 1.8	set-00	dic-09	4	AB6004AT	-	DEXRON II
OPEL	CORSA C Furgone/hatchback (X01)	1.4	ago-03	giu-12	4	AB6004AT	-	DEXRON II
OPEL	CORSA D (S07)	1.0; 1.2; 1.2 LPG; 1.3 CDTi; 1.4; 1.4 LPG; 1.6 Turbo; 1.7 CDTi	lug-06	ago-14	4	AB6004AT	-	DEXRON II
OPEL	CORSA D Furgone/hatchback (S07)	1.2; 1.4	giu-10	ago-14	4	AB6004AT	-	DEXRON II
OPEL	INSIGNIA B Grand Sport (Z18)	2.0; 2.0 GSi 4x4; 2.0 Turbo	apr-20	In produzione	8 / 9	AB6039AT + AB6040AT	-	DEXRON HP
OPEL	INSIGNIA B Sports Tourer (Z18)	2.0; 2.0 4x4	apr-20	In produzione	8 / 9	AB6039AT + AB6040AT	-	DEXRON HP
OPEL	TIGRA (S93)	1.4 16V; 1.6 16V	lug-94	dic-00	4	AB6004AT	-	DEXRON II
OPEL	VECTRA B (J96)	1.6 i; 1.6 i 16V; 1.7 TD; 1.8 i 16V; 2.0 DI 16V; 2.0 DTi 16V; 2.0 i; 2.0 i 16V; 2.2 DTi 16V; 2.2 i 16V; 2.5 i V6; 2.6 i V6; i 500 2.5	set-95	apr-02	4	AB6004AT	-	DEXRON II
OPEL	VECTRA B Familiare (J96)	1.6 i; 1.6 i 16V; 1.8 i 16V; 2.0 DI 16V; 2.0 DTi 16V; 2.0 i; 2.0 i 16V; 2.2 DTi 16V; 2.2 i 16V; 2.5 i V6; 2.6 i V6; i 500 2.5	nov-96	lug-03	4	AB6004AT	-	DEXRON II
OPEL	VECTRA B Hatchback (J96)	1.6 i; 1.6 i 16V; 1.7 TD; 1.8 i 16V; 2.0 DI 16V; 2.0 DTi 16V; 2.0 i; 2.0 i 16V; 2.2 DTi 16V; 2.2 i 16V; 2.5; 2.5 i V6; 2.6 i V6	set-95	lug-03	4	AB6004AT	-	DEXRON II
OPEL	ZAFIRA A MPV / Space wagon (T98)	1.6; 1.6 16V; 1.6 LPG; 1.8 16V; 2.2 16V	apr-99	giu-05	4	AB6004AT	-	DEXRON II
PEUGEOT	301	1.6 LPG; 1.6 VTi 115	nov-12	In produzione	4	AB6101AT	-	PSA 97.36.22
PEUGEOT	2008 I (CU_)	1.6 VTi	mar-13	In produzione	4	AB6101AT	-	PSA 97.36.22
PEUGEOT	206 CC (2D)	1.6; 1.6 16V	set-00	dic-08	4	AB6101AT	-	PSA 97.36.22
PEUGEOT	206 Hatchback (2A/C)	1.4 i; 1.4 LPG; 1.6; 1.6 16V; 1.6 8V; 1.6 BiFuel; 1.6 i	set-98	dic-12	4	AB6101AT	-	PSA 97.36.22
PEUGEOT	206 SW (2E/K)	1.4; 1.6; 1.6 16V; 1.6 LPG	lug-02	In produzione	4	AB6101AT	-	PSA 97.36.22
PEUGEOT	206 Tre volumi	1.6 16V	mar-07	In produzione	4	AB6101AT	-	PSA 97.36.22
PEUGEOT	207 (WA_, WC_)	1.6 VTi	mar-07	dic-12	4	AB6101AT	-	PSA 97.36.22

Marca / Brand:	Modello / Model:	Versioni / Version:	Da anno / From:	Ad anno / To:	Marce / Gears:	Codice AB PARTS		Lubrificante Consigliato
PEUGEOT	207 CC (WD_)	1.6 16V; 1.6 16V Turbo	feb-07	ott-13	4	AB6101AT	-	PSA 97.36.22
PEUGEOT	207 SW (WK_)	1.6 16V RC; 1.6 16V Turbo	feb-07	dic-12	4	AB6101AT	-	PSA 97.36.22
PEUGEOT	207/207+ (WA_, WC_)	1.6 16V RC; 1.6 16V Turbo; 1.6 16V VTI	feb-06	ott-13	4	AB6101AT	-	PSA 97.36.22
PEUGEOT	208 I (CA_, CC_)	1.6 THP; 1.6 VTI	mar-12	dic-19	4	AB6101AT	-	PSA 97.36.22
PEUGEOT	306 (7B, N3, N5)	1.6; 1.6 SR; 2.0	giu-94	mag-01	4	AB6101AT	-	PSA 97.36.22
PEUGEOT	306 Break (7E, N3, N5)	1.6; 2.0; 2.0 16V	mar-97	apr-02	4	AB6101AT	-	PSA 97.36.22
PEUGEOT	306 Cabriolet (7D, N3, N5)	1.6; 2.0 16V	apr-96	apr-02	4	AB6101AT	-	PSA 97.36.22
PEUGEOT	306 Hatchback (7A, 7C, N3, N5)	1.6; 2.0 16V; 2.0 S16	mag-93	mag-01	4	AB6101AT	-	PSA 97.36.22
PEUGEOT	307 (3A/C)	1.6; 1.6 16V; 1.6 BioFlex; 1.6 Flex; 2.0; 2.0 16V	ago-00	dic-12	4	AB6101AT	-	PSA 97.36.22
PEUGEOT	307 Break (3E)	1.6 16V; 1.6 BioFlex; 2.0; 2.0 16V	mar-02	apr-08	4	AB6101AT	-	PSA 97.36.22
PEUGEOT	307 CC (3B)	1.6 16V; 2.0 16V	mar-03	giu-09	4	AB6101AT	-	PSA 97.36.22
PEUGEOT	307 SW (3H)	1.6 16V; 1.6 BioFlex; 2.0 16V	mar-02	apr-08	4	AB6101AT	-	PSA 97.36.22
PEUGEOT	308 CC (4B_)	1.6 16V; 2.0 CVVT	giu-09	dic-14	4	AB6101AT	-	PSA 97.36.22
PEUGEOT	308 I (4A_, 4C_)	1.6 16V; 1.6 THP 16V; 2.0 Bioflex	set-07	ott-14	4	AB6101AT	-	PSA 97.36.22
PEUGEOT	308 SW I (4E_, 4H_)	1.6 16V; 1.6 THP 16V; 2.0	set-07	ott-14	4	AB6101AT	-	PSA 97.36.22
PEUGEOT	406 (8B)	1.6; 1.8; 1.8 16V; 1.8 Bifuel; 1.9 D; 1.9 TD; 2.0; 2.0 16V; 2.0 16V HPI; 2.0 HDI 110; 2.0 HDI 90; 2.0 Turbo; 2.1 TD 12V; 2.2; 2.2 HDI; 3.0 24V; 3.0 V6	ott-95	giu-04	4	AB6101AT	-	PSA 97.36.22
PEUGEOT	406 (8B)	1.6; 1.8; 1.8 16V; 1.8 Bifuel; 2.0 16V; 2.0 16V HPI; 2.0 HDI 110; 2.0 HDI 90; 2.2; 2.2 HDI; 3.0 24V; 3.0 V6	nov-95	giu-04	4	AB6143AT	-	ESSO LT 71141
PEUGEOT	406 Break (8E/F)	1.8; 1.8 16V; 1.8 Bifuel; 1.9 D; 1.9 TD; 2.0; 2.0 16V; 2.0 16V HPI; 2.0 HDI 110; 2.0 HDI 90; 2.0 Turbo; 2.1 TD 12V; 2.2; 2.2 HDI; 3.0 24V; 3.0 V6	ott-96	ott-04	4	AB6101AT	-	PSA 97.36.22
PEUGEOT	406 Break (8E/F)	1.8; 1.8 16V; 1.8 Bifuel; 2.0 16V; 2.0 16V HPI; 2.0 HDI 110; 2.0 HDI 90; 2.2; 2.2 HDI; 3.0 24V; 3.0 V6	ott-96	ott-04	4	AB6143AT	-	ESSO LT 71141
PEUGEOT	406 Coupé (8C)	2.0 16V; 2.2; 2.2 HDI; 3.0 24V; 3.0 V6; 3.0 V6 24V	mar-97	dic-04	4	AB6101AT	-	PSA 97.36.22
PEUGEOT	406 Coupé (8C)	2.0 16V; 2.2; 2.2 HDI; 3.0 24V; 3.0 V6; 3.0 V6 24V	mar-97	dic-04	4	AB6143AT	-	ESSO LT 71141
PEUGEOT	407 (6D_)	1.6 HDi 110; 1.8; 1.8 16V; 2.0; 2.0 16V; 2.0 Bioflex; 2.0 Flex; 2.0 HDI; 2.0 HDi 135; 2.2; 2.2 16V; 2.2 HDI; 2.2 HDi 170; 2.7 HDI; 3.0	mar-04	feb-11	4	AB6143AT	-	ESSO LT 71141
PEUGEOT	407 (6D_)	2.0; 2.0 16V; 2.0 Bioflex; 2.0 Flex	mar-04	feb-11	4	AB6101AT	-	PSA 97.36.22
PEUGEOT	407 Coupé (6C_)	2.0 HDI; 2.2 16V; 2.7 HDI; 3.0 HDI; 3.0 V6	ott-05	In produzione	4	AB6143AT	-	ESSO LT 71141
PEUGEOT	407 SW (6E_, 6D_)	1.6 HDi 110; 1.8; 1.8 16V; 2.0; 2.0 16V; 2.0 Bioflex; 2.0 Flex; 2.0 HDI; 2.0 HDi 135; 2.2; 2.2 16V; 2.2 HDI; 2.2 HDi 170; 2.7 HDI; 3.0	mag-04	feb-11	4	AB6143AT	-	ESSO LT 71141
PEUGEOT	407 SW (6E_, 6D_)	2.0; 2.0 16V; 2.0 Bioflex; 2.0 Flex	mag-04	feb-11	4	AB6101AT	-	PSA 97.36.22
PEUGEOT	607 (9D, 9U)	2.0; 2.0 HDI; 2.2 16V; 2.2 HDI; 2.7 HDi 24V; 3.0 V6 24V	feb-00	lug-11	4	AB6143AT	-	ESSO LT 71141
PEUGEOT	806 (221)	2.0 16V	set-00	ago-02	4	AB6101AT	-	PSA 97.36.22
PEUGEOT	806 Van (AF_)	2.0	mag-98	feb-03	4	AB6101AT	-	PSA 97.36.22
PEUGEOT	807 (EB_)	2.0; 2.0 16V; 2.0 HDi	giu-02	In produzione	4	AB6101AT	-	PSA 97.36.22
PEUGEOT	807 (EB_)	3.0 V6	giu-02	In produzione	4	AB6143AT	-	ESSO LT 71141
PEUGEOT	807 Van (EB_)	2.0 HDi	giu-02	mag-06	4	AB6101AT	-	PSA 97.36.22
PEUGEOT	BOXER Pianale piatto/Telaio (244)	2.0 HDi	dic-01	giu-06	5	AB6078AT	-	MB 236.14
PEUGEOT	EXPERT (224_)	2.0	lug-00	dic-06	4	AB6101AT	-	PSA 97.36.22
PEUGEOT	EXPERT Furgone (222)	2.0	set-02	dic-06	4	AB6101AT	-	PSA 97.36.22
PORSCHE	928	4.7 S; 5.0 GT; 5.0 S; 5.0 S, S4; 5.0 S4 Cat; 5.4 GTS	set-79	nov-95	4	AB6076AT	-	MB A000989203

Marca / Brand:	Modello / Model:	Versioni / Version:	Da anno / From:	Ad anno / To:	Marce / Gears:	Codice AB PARTS		Lubrificante Consigliato
PORSCHE	911 (996)	3.4 Carrera; 3.4 Carrera 4; 3.6 Carrera; 3.6 Carrera 4; 3.6 Carrera 4S; 3.6 Carrera S; 3.6 GT2; 3.6 Turbo 4; 3.6 Turbo 4S	ago-97	ago-05	5	AB6079AT	-	MB 236.14
PORSCHE	911 (997)	3.6 Carrera; 3.6 Carrera 4; 3.6 Turbo; 3.8 Carrera 4S; 3.8 Carrera S	lug-04	dic-09	5	AB6079AT	-	MB 236.14
PORSCHE	911 Cabriolet (996)	3.4 Carrera; 3.4 Carrera 4; 3.6 Carrera; 3.6 Carrera 4; 3.6 Carrera 4S; 3.6 Carrera S; 3.6 S; 3.6 Turbo 4; 3.6 Turbo 4S	ago-97	ago-05	5	AB6079AT	-	MB 236.14
PORSCHE	911 Cabriolet (997)	3.6 Carrera; 3.6 Carrera 4; 3.6 Turbo; 3.8 Carrera 4S; 3.8 Carrera S	apr-05	dic-10	5	AB6079AT	-	MB 236.14
PORSCHE	911 Targa (996)	3.6	dic-01	ago-05	5	AB6079AT	-	MB 236.14
PORSCHE	911 Targa (997)	3.6 Carrera 4; 3.8 Carrera 4S	lug-06	dic-08	5	AB6079AT	-	MB 236.14
PORSCHE	CAYENNE (92A)	3.0 Diesel; 3.0 S E-Hybrid; 3.6; 3.6 GTS; 3.6 S; 4.2 S Diesel; 4.8 GTS; 4.8 S; 4.8 Turbo; 4.8 Turbo S	giu-10	In produzione	8	AB6011AT	-	VW G055540A2
PORSCHE	CAYENNE (9PA)	3.0 TDI; 3.2; 3.6; GTS 4.8; S 4.5; S 4.8; Turbo 4.5; Turbo S 4.5; Turbo S 4.8	set-02	set-10	6	AB6010AT	-	VW G055025A2
PORSCHE	CAYENNE (9YA)	2.9 S AWD; 3.0 AWD; 3.0 E-Hybrid AWD; 4.0 GTS; 4.0 Turbo AWD; 4.0 Turbo S E-Hybrid AWD	mag-17	In produzione	8	AB6175AT	-	ZF Lifeguard Fluid 8
PORSCHE	CAYENNE Coupe (9YB)	2.9 S AWD; 3.0 AWD; 3.0 E-Hybrid AWD; 4.0 GTS AWD; 4.0 Turbo AWD; 4.0 Turbo GT AWD; 4.0 Turbo S E-Hybrid AWD	gen-19	In produzione	8	AB6175AT	-	ZF Lifeguard Fluid 8
PORSCHE	MACAN (95B)	2.0; 2.9 GTS; 2.9 Turbo AWD; 3.0 GTS; 3.0 S; 3.0 S Diesel; 3.6 Turbo	feb-14	In produzione	7	AB6107AT + AB6108AT *	- AB6109AT * AB6110AT *	VW G052529A2 + G055532A2
PORSCHE	PANAMERA (970)	3.0 4S; 3.0 D; 3.0 S; 3.0 S E-Hybrid; 3.6; 3.6 4; 4.8 4S; 4.8 GTS; 4.8 S; 4.8 Turbo; 4.8 Turbo S	set-09	ott-16	8	AB6011AT	-	VW G055540A2
PORSCHE	PANAMERA (971)	2.9; 2.9 4; 2.9 4 E-Hybrid; 2.9 4S; 2.9 4S E-Hybrid; 3.0; 3.0 4; 4.0 GTS; 4.0 S 4 Diesel; 4.0 Turbo; 4.0 Turbo S E-Hybrid	mag-16	In produzione	4	AB6044AT	-	ZF LIFEGUARD 8.2
PORSCHE	PANAMERA Sport Turismo (971)	2.9 4; 2.9 4 E-Hybrid; 2.9 4S; 2.9 4S E-Hybrid; 3.0 4; 4.0 GTS; 4.0 S 4 Diesel; 4.0 Turbo; 4.0 Turbo S E-Hybrid	mag-17	In produzione	4	AB6044AT	-	ZF LIFEGUARD 8.2
RENAULT	ARKANA I (LCM_, LDN_)	1.3 TCe 150; 1.3 TCe 150 4x4	ago-19	In produzione	CVT	AB6064AT + AB6068AT	-	NISSAN NS3 CVT
RENAULT	ARKANA I (LCM_, LDN_)	1.6	ago-19	In produzione	CVT	AB6064AT + AB6065AT	-	MITSUBISHI CVTF-J4
RENAULT	CLIO II (BB_, CB_)	1.4; 1.4 16V; 1.6; 1.6 16V	set-98	feb-09	4	AB6101AT	-	PSA 97.36.22
RENAULT	CLIO II Furgone/hatchback (SB0/1/2_)	1.6	nov-03	In produzione	4	AB6101AT	-	PSA 97.36.22
RENAULT	CLIO III (BR0/1, CR0/1)	1.2; 1.2 16V; 1.2 16V Hi-Flex; 1.2 Ethanol; 1.4 16V; 1.5 dCi; 1.6 16V; 1.6 16V GT; 2.0 16V; 2.0 16V Sport	mag-05	dic-14	4	AB6101AT	-	PSA 97.36.22
RENAULT	CLIO III Furgone/hatchback (SB_, SR_)	1.2; 1.5 dCi	giu-05	dic-14	4	AB6101AT	-	PSA 97.36.22
RENAULT	CLIO III Sportour (KR0/1_)	1.2 16V; 1.2 16V Hi-Flex; 1.4 16V; 1.5 dCi; 1.6 16V	nov-07	dic-14	4	AB6101AT	-	PSA 97.36.22
RENAULT	DUSTER (HM_)	1.5 dCi 110	lug-19	In produzione	CVT	AB6064AT + AB6065AT	-	MITSUBISHI CVTF-J4
RENAULT	DUSTER (HS_)	2.0; 2.0 4x4	feb-12	In produzione	4	AB6101AT	-	PSA 97.36.22
RENAULT	ESPACE III (JE0_)	2.0; 2.0 16V	ott-98	ott-02	4	AB6101AT	-	PSA 97.36.22
RENAULT	ESPACE IV (JK0/1_)	2.0	nov-02	gen-15	4	AB6101AT	-	PSA 97.36.22
RENAULT	ESPACE V (JR_)	1.6 dCi 130; 1.6 dCi 160; 2.0 Blue dCi 160; 2.0 Blue dCi 200	giu-15	mar-23	6	AB6098AT + AB6100AT *	- AB6099AT *	FORD 1490763
RENAULT	FLUENCE (L3_)	1.6 16V; 1.6 LPG 16V	feb-10	In produzione	4	AB6101AT	-	PSA 97.36.22
RENAULT	GRAND SCÉNIC II (JM0/1_)	1.5 dCi; 1.6; 1.9 dCi; 2.0; 2.0 dCi	apr-04	giu-09	4	AB6101AT	-	PSA 97.36.22
RENAULT	GRAND SCÉNIC IV (R9_)	1.6 dCi 130; 1.6 dCi 160; 1.7 Blue dCi 120; 1.7 Blue dCi 150	set-16	mar-23	6	AB6098AT + AB6100AT *	- AB6099AT *	FORD 1490763

Marca / Brand:	Modello / Model:	Versioni / Version:	Da anno / From:	Ad anno / To:	Marce / Gears:	Codice AB PARTS		Lubrificante Consigliato
RENAULT	KANGOO (KC0/1_)	1.4; 1.6 16V; 1.6 16V 4x4	ago-97	In produzione	4	AB6101AT	-	PSA 97.36.22
RENAULT	KANGOO / GRAND KANGOO II (KW0/1_)	1.6 16V; 1.6 16V FLEX; 1.6 16V LPG	feb-08	In produzione	4	AB6101AT	-	PSA 97.36.22
RENAULT	KANGOO Express (FC0/1_)	1.4; 1.6 16V; 1.6 16V 4x4; 1.6 16V bivalent	ago-97	In produzione	4	AB6101AT	-	PSA 97.36.22
RENAULT	KANGOO Express (FW0/1_)	1.6 16V; 1.6 16V FLEX; 1.6 16V LPG	feb-08	In produzione	4	AB6101AT	-	PSA 97.36.22
RENAULT	KOLEOS I (HY_)	2.5 (HY0C, HY0N); 2.5 4x4 (HY0C, HY0N)	set-08	mar-16	CVT	AB6062AT + AB6063AT	-	NISSAN NS2 o NS3
RENAULT	KOLEOS II (HC_)	1.7 BLUE dCi 150; 2.0 BLUE dCi 190 4WD; 2.0 dCi 175; 2.0 dCi 175 4WD	apr-16	In produzione	CVT	AB6064AT + AB6066AT	-	MITSUBISHI CVTF-J4
RENAULT	KOLEOS II (HC_)	2.0 BLUE DCI 185; 2.0 BLUE DCI 185 4WD	gen-20	In produzione	CVT	AB6064AT + AB6067AT	-	MITSUBISHI CVTF-J4
RENAULT	KOLEOS II (HC_)	2.0 dCi 175 (HCAK); 2.0 dCi 175 4WD	apr-16	In produzione	CVT	AB6062AT + AB6063AT	-	NISSAN NS2 o NS3
RENAULT	KOLEOS II (HC_)	2.0 dCi 175; 2.0 dCi 175 4WD	apr-16	In produzione	CVT	AB6061AT + AB6063AT	-	NISSAN NS2 o NS3
RENAULT	LAGUNA I (B56_, 556_)	1.9 dTi; 2.0	nov-93	mar-01	4	AB6101AT	-	PSA 97.36.22
RENAULT	LAGUNA I Grandtour (K56_)	1.9 dTi; 2.0	set-95	mar-01	4	AB6101AT	-	PSA 97.36.22
RENAULT	LAGUNA II (BG0/1_)	1.6 16V; 1.6 LPG; 1.8 16V; 1.9 dCi; 2.0 16V; 2.0 16V IDE; 2.0 16V Turbo; 2.0 dCi; 2.2 dCi; 2.9 V6 24V; 3.0 V6 24V	mar-01	dic-07	4	AB6101AT	-	PSA 97.36.22
RENAULT	LAGUNA II Grandtour (KG0/1_)	1.6 16V; 1.6 Bifuel; 1.8 16V; 1.9 dCi; 2.0 16V; 2.0 16V IDE; 2.0 16V Turbo; 2.0 dCi; 2.2 dCi; 2.9 V6 24V; 3.0 V6 24V	mar-01	dic-07	4	AB6101AT	-	PSA 97.36.22
RENAULT	LOGAN I (LS_)	1.6	apr-07	ott-13	4	AB6101AT	-	PSA 97.36.22
RENAULT	LOGAN I Familiare (KS_)	1.6	apr-07	In produzione	4	AB6101AT	-	PSA 97.36.22
RENAULT	LOGAN II Familiare (K8_)	1.6	dic-13	In produzione	4	AB6101AT	-	PSA 97.36.22
RENAULT	LOGAN/STEPWAY II (L8_)	1.6	apr-14	In produzione	4	AB6101AT	-	PSA 97.36.22
RENAULT	MEGANE I (BA0/1_)	1.6 16V; 1.6 LPG; 1.9 DCI; 1.9 dTi; 1.9 TDI; 2.0; 2.0 i	gen-96	dic-04	4	AB6101AT	-	PSA 97.36.22
RENAULT	MEGANE I Cabriolet (EA0/1_)	1.6 16V; 2.0 i	mar-99	ago-03	4	AB6101AT	-	PSA 97.36.22
RENAULT	MEGANE I Classic (LA0/1_)	1.6 16V; 1.9 dCi; 1.9 dTi; 1.9 TDI; 2.0; 2.0 i; 2.0 RT	set-96	ago-03	4	AB6101AT	-	PSA 97.36.22
RENAULT	MEGANE I Coach (DA0/1_)	1.6 16V; 1.9 DCI; 1.9 dTi; 2.0 i	mar-96	ago-03	4	AB6101AT	-	PSA 97.36.22
RENAULT	MEGANE I Grandtour (KA0/1_)	1.6 16V; 1.9 dCi; 1.9 dTi	mar-99	ago-03	4	AB6101AT	-	PSA 97.36.22
RENAULT	MEGANE I Hatchback Van (SA0/1_)	1.9 dCi	ott-00	lug-03	4	AB6101AT	-	PSA 97.36.22
RENAULT	Megane I Kombi van (KA_)	1.6; 1.6 BiFuel; 1.9 dCi; 1.9 DTI	apr-01	lug-03	4	AB6101AT	-	PSA 97.36.22
RENAULT	MEGANE II (BM0/1_, CM0/1_)	1.4 16V; 1.5 dCi; 1.6; 1.6 16V; 1.6 Bifuel; 1.6 Flex-Fuel; 1.9 dCi; 2.0; 2.0 16V; 2.0 16V Turbo; 2.0 dCi; 2.0 Renault Sport	set-02	dic-09	4	AB6101AT	-	PSA 97.36.22
RENAULT	MEGANE II Coupé-Cabriolet (EM0/1_)	1.5 dCi; 1.6; 1.6 16V; 1.9 dCi; 2.0; 2.0 16V Turbo; 2.0 dCi	set-03	dic-09	4	AB6101AT	-	PSA 97.36.22
RENAULT	MEGANE II Familiare (KM0/1_)	1.4; 1.5 dCi; 1.6; 1.6 16V; 1.6 16V Hi-Flex; 1.6 LPG 16V; 1.9 dCi; 2.0; 2.0 dCi	ago-03	ott-11	4	AB6101AT	-	PSA 97.36.22
RENAULT	MEGANE II Furgone/familiare (KM_)	1.5 dCi; 1.6	ago-03	lug-09	4	AB6101AT	-	PSA 97.36.22
RENAULT	MEGANE II Hatchback Van (KM0/2_)	1.5 dCi	ago-03	mar-09	4	AB6101AT	-	PSA 97.36.22
RENAULT	MEGANE II Tre volumi (LM0/1_)	1.4; 1.5 dCi; 1.6; 1.6 16V; 1.9 dCi; 2.0; 2.0 dCi	ago-03	In produzione	4	AB6101AT	-	PSA 97.36.22
RENAULT	MEGANE IV Grand Coupe	1.6 dCi 130	ott-16	In produzione	6	AB6098AT + AB6100AT *	AB6099AT *	FORD 1490763

Marca / Brand:	Modello / Model:	Versioni / Version:	Da anno / From:	Ad anno / To:	Marce / Gears:	Codice AB PARTS		Lubrificante Consigliato
RENAULT	MEGANE IV Grand Coupe	1.6 SCe	ott-16	In produzione	CVT	AB6064AT + AB6065AT	-	MITSUBISHI CVTF-J4
RENAULT	MEGANE IV Hatchback (B9A/M/N_)	1.6 16V	nov-15	In produzione	CVT	AB6064AT + AB6065AT	-	MITSUBISHI CVTF-J4
RENAULT	MEGANE IV Hatchback (B9A/M/N_)	1.6 dCi 130; 1.6 dCi 165; 1.8 Blue dCi 150; 1.8 RS 300; 1.8 RS TCe 280	nov-15	In produzione	6	AB6098AT + AB6100AT *	- AB6099AT *	FORD 1490763
RENAULT	MEGANE IV Sporter (K9A/M/N_)	1.6 dCi 130; 1.6 dCi 165; 1.8 Blue dCi 150	apr-16	In produzione	6	AB6098AT + AB6100AT *	- AB6099AT *	FORD 1490763
RENAULT	MEGANE Scénic (JA0/1_)	1.6 16V	apr-98	ott-99	4	AB6101AT	-	PSA 97.36.22
RENAULT	MODUS / GRAND MODUS (F/JP0_)	1.2; 1.2 16V; 1.2 16V Hi-Flex; 1.2 GPL; 1.4; 1.5 dCi; 1.5 dCi 75; 1.5 dCi 90; 1.6	set-04	In produzione	4	AB6101AT	-	PSA 97.36.22
RENAULT	SANDERO/STEPWAY I (BS_)	1.6	dic-07	In produzione	4	AB6101AT	-	PSA 97.36.22
RENAULT	SANDERO/STEPWAY II (B8_)	1.6	set-16	In produzione	CVT	AB6064AT + AB6065AT	-	MITSUBISHI CVTF-J4
RENAULT	SANDERO/STEPWAY II (B8_)	1.6 16V	apr-14	In produzione	4	AB6101AT	-	PSA 97.36.22
RENAULT	SCÉNIC I MPV / Space wagon (JA0/1_, FA0_)	1.6; 1.6 BiFuel; 1.9 dCi; 1.9 dCi RX4; 1.9 dTi; 2.0 16V	set-99	set-03	4	AB6101AT	-	PSA 97.36.22
RENAULT	SCÉNIC II (JM0/1_)	1.4; 1.5 dCi; 1.6; 1.6 16V; 1.6 BiFuel; 1.9 D; 1.9 dCi; 1.9 dCi 130; 2.0; 2.0 16V Turbo; 2.0 dCi	giu-03	dic-09	4	AB6101AT	-	PSA 97.36.22
RENAULT	SCÉNIC IV (J9_)	1.6 dCi 130; 1.6 dCi 160; 1.7 Blue dCi 120; 1.7 Blue dCi 150	set-16	lug-22	6	AB6098AT + AB6100AT *	- AB6099AT *	FORD 1490763
RENAULT	TALISMAN (LP_)	1.6 dCi 130; 1.6 dCi 160; 2.0 Blue dCi 160; 2.0 Blue dCi 190; 2.0 Blue dCi 200	giu-15	mar-22	6	AB6098AT + AB6100AT *	- AB6099AT *	FORD 1490763
RENAULT	TALISMAN Grandtour (KP_)	1.6 dCi 130; 1.6 dCi 160; 2.0 Blue dCi 160; 2.0 Blue dCi 190; 2.0 Blue dCi 200	mar-16	mar-22	6	AB6098AT + AB6100AT *	- AB6099AT *	FORD 1490763
RENAULT	TRAFIC III Autobus (JG_)	1.6 dCi 120; 2.0 dCi 110; 2.0 dCi 120; 2.0 dCi 145; 2.0 dCi 150; 2.0 dCi 170	gen-19	In produzione	6	AB6098AT + AB6100AT *	- AB6099AT *	FORD 1490763
RENAULT	TRAFIC III Furgone (FG_)	2.0 dCi 110; 2.0 dCi 120; 2.0 dCi 130; 2.0 dCi 145; 2.0 dCi 150; 2.0 dCi 170	giu-19	In produzione	6	AB6098AT + AB6100AT *	- AB6099AT *	FORD 1490763
RENAULT	TRAFIC III Pianale piatto/Telaio (EG_)	2.0 dCi 145; 2.0 dCi 150; 2.0 dCi 170	giu-19	In produzione	6	AB6098AT + AB6100AT *	- AB6099AT *	FORD 1490763
ROLLS-ROYCE	GHOST I (RR4)	V12; V-Specification	dic-09	mar-20	8	AB6164AT	-	ZF Lifeguard Fluid 8
ROLLS-ROYCE	PHANTOM VII (RR1)	V12	gen-03	lug-17	8	AB6164AT	-	ZF Lifeguard Fluid 8
ROLLS-ROYCE	PHANTOM VII (RR1)	V12	gen-03	lug-17	6	AB6163AT	-	ZF Lifeguard Fluid 6
ROLLS-ROYCE	PHANTOM VII Coupé (RR3)	6.75 V12	giu-08	lug-17	8	AB6164AT	-	ZF Lifeguard Fluid 8
ROLLS-ROYCE	PHANTOM VII Coupé (RR3)	6.75 V12	giu-08	lug-17	6	AB6163AT	-	ZF Lifeguard Fluid 6
ROLLS-ROYCE	PHANTOM VII Drophead Coupe (RR2)	6.75 V12	giu-07	lug-17	8	AB6164AT	-	ZF Lifeguard Fluid 8
ROLLS-ROYCE	PHANTOM VII Drophead Coupe (RR2)	6.75 V12	giu-07	lug-17	6	AB6163AT	-	ZF Lifeguard Fluid 6
ROLLS-ROYCE	PHANTOM VIII (RR11, RR12)	V12, V12 EWB	set-17	In produzione	8	AB6164AT	-	ZF Lifeguard Fluid 8
ROLLS-ROYCE	PHANTOM VIII (RR11, RR12)	V12, V12 EWB	set-17	In produzione	6	AB6163AT	-	ZF Lifeguard Fluid 6
ROLLS-ROYCE	WRAITH (RR5)	V12	ago-13	In produzione	8	AB6164AT	-	ZF Lifeguard Fluid 8
SAAB	9-3 (YS3D)	2.0 SE Turbo	feb-98	set-02	8	AB6164AT	-	ZF Lifeguard Fluid 8

Marca / Brand:	Modello / Model:	Versioni / Version:	Da anno / From:	Ad anno / To:	Marce / Gears:	Codice AB PARTS		Lubrificante Consigliato
SAAB	9-3 Cabriolet (YS3D)	2.0 SE Turbo	feb-98	ago-03	8	AB6164AT	-	ZF Lifeguard Fluid 8
SEAT	ALHAMBRA (710, 711)	1.4 TSI; 1.8 TSI; 2.0 TDI; 2.0 TDI 4Drive; 2.0 TSI	giu-10	dic-22	6	AB6025AT + AB6026AT	-	VW G052182
SEAT	ALHAMBRA (710, 711)	1.4 TSI; 2.0 TDI; 2.0 TDI 4Drive; 2.0 TSI	giu-10	apr-15	6	AB6025AT + AB6027AT	-	VW G052182
SEAT	ALHAMBRA (7V8, 7V9)	1.8 T 20V; 1.9 TDI; 1.9 TDI 4motion; 2.0 i; 2.0 TDI; 2.8 V6; 2.8 V6 4motion	apr-96	mar-10	5	AB6072AT	-	ATF Type K17
SEAT	ALHAMBRA VAN (711)	TDI; TSI	mag-15	dic-22	6	AB6025AT + AB6026AT	-	VW G052182
SEAT	ALTEA (5P1)	1.2 TSI; 1.6; 1.6 LPG; 1.6 Multifuel; 1.6 TDI; 1.8 TFSI	mar-04	lug-15	7	AB6024AT	-	Meccatronica: VW G004000 Cambio: VW G052171
SEAT	ALTEA (5P1)	1.4 TSI; 1.8 TFSI; 1.9 TDI; 2.0 TDI; 2.0 TDI 16V; 2.0 TFSI	mar-04	lug-15	6	AB6025AT + AB6027AT	-	VW G052182
SEAT	ALTEA (5P1)	1.9 TDI; 2.0 TDI; 2.0 TDI 16V; 2.0 TFSI	mar-04	lug-15	6	AB6025AT + AB6026AT	-	VW G052182
SEAT	ALTEA (5P1)	2.0 FSI; 2.0 TDI; 2.0 TDI 16V	mar-04	lug-15	6	AB6136AT	-	VW G055025A2
SEAT	ALTEA (5P1)	2.0 FSI; 2.0 TFSI	mag-04	mag-09	6	AB6137AT	-	VW G055025A2
SEAT	ALTEA XL (5P5, 5P8)	1.2 TSI; 1.6; 1.6 LPG; 1.6 Multifuel; 1.6 TDI; 1.8 TFSI	ott-06	lug-15	7	AB6024AT	-	Meccatronica: VW G004000 Cambio: VW G052171
SEAT	ALTEA XL (5P5, 5P8)	1.4 TSI; 1.8 TFSI; 1.9 TDI; 2.0 TDI; 2.0 TDI 16V; 2.0 TDI 4x4; 2.0 TFSI 4x4	ott-06	lug-15	6	AB6025AT + AB6027AT	-	VW G052182
SEAT	ALTEA XL (5P5, 5P8)	1.9 TDI; 2.0 TDI; 2.0 TDI 16V; 2.0 TDI 16V 4x4; 2.0 TDI 4x4; 2.0 TFSI; 2.0 TFSI 4x4	ott-06	lug-15	6	AB6025AT + AB6026AT	-	VW G052182
SEAT	ALTEA XL (5P5, 5P8)	2.0 FSI; 2.0 TFSI; 2.0 TFSI 4x4	ott-06	lug-15	6	AB6137AT	-	VW G055025A2
SEAT	ARONA (KJ7, KJP)	1.0 TGI; 1.0 TSI; 1.5 TSI; 1.6 SRE; 1.6 TDI	lug-17	In produzione	7	AB6024AT	-	Meccatronica: VW G004000 Cambio: VW G052171
SEAT	ARONA (KJ7, KJP)	1.6 SRE	lug-17	In produzione	6	AB6138AT *	AB6139AT *	VW G055025A2
SEAT	ATECA (KH7, KHP)	1.0 TSI; 1.4 TSI; 1.4 TSI 4Drive; 1.5 TSI; 1.5 TSI 4Drive; 1.6 TDI; 2.0 TDI; 2.0 TDI 4Drive; 2.0 TSI 4Drive	apr-16	In produzione	7	AB6024AT	-	Meccatronica: VW G004000 Cambio: VW G052171
SEAT	ATECA (KH7, KHP)	1.4 TSI; 1.4 TSI 4Drive; 2.0 TDI; 2.0 TDI 4Drive	apr-16	In produzione	6	AB6025AT + AB6026AT	-	VW G052182
SEAT	CORDOBA (6K1, 6K2)	1.0 i; 1.4; 1.4 16V; 1.4 i; 1.4 i 16V; 1.6 i; 1.8 i; 1.8 i 16V; 1.8 T 20V Cupra; 1.9 D; 1.9 SDI; 1.9 TD; 1.9 TDI; 2.0 i; 2.0 i 16V	feb-93	ott-02	4	AB6134AT	-	VW G052162A2 + 75W90 Gl4
SEAT	CORDOBA (6L2)	1.4 16V	set-02	dic-07	4	AB6069AT	-	AISIN ATF-0T4
SEAT	CORDOBA Vario (6K5)	1.4; 1.4 16V; 1.4 i; 1.6 i; 1.9 SDI; 1.9 TDI	ago-96	dic-02	4	AB6134AT	-	VW G052162A2 + 75W90 Gl4
SEAT	CORDOBA VARIO Furgone/familiare (6K5)	1.9 TDI	ago-00	dic-02	4	AB6134AT	-	VW G052162A2 + 75W90 Gl4
SEAT	EXEO (3R2)	1.6; 1.8 T; 1.8 TSI; 2.0 TDI; 2.0 TFSI	dic-08	mag-13	CVT	AB6013AT	-	AUDI G052180A2
SEAT	EXEO ST (3R5)	1.6; 1.8 T; 1.8 TSI; 2.0 TDI; 2.0 TFSI	mag-09	mag-13	CVT	AB6013AT	-	AUDI G052180A2
SEAT	IBIZA II (6K1)	1.0; 1.3 i; 1.4 i; 1.4 i 16V; 1.6 i; 1.8 i; 1.8 i 16V; 1.9 D; 1.9 SDI; 1.9 TD; 1.9 TDI; 2.0 i; 2.0 i 16V	mar-93	feb-02	4	AB6134AT	-	VW G052162A2 + 75W90 Gl4
SEAT	IBIZA III (6L1)	1.4 16V	feb-02	dic-07	4	AB6069AT	-	AISIN ATF-0T4

Marca / Brand:	Modello / Model:	Versioni / Version:	Da anno / From:	Ad anno / To:	Marce / Gears:	Codice AB PARTS		Lubrificante Consigliato
SEAT	IBIZA IV (6J5, 6P1)	1.0; 1.0 TSI; 1.2; 1.2 LPG; 1.2 TDI; 1.2 TSI; 1.4; 1.4 LPG; 1.4 TDI; 1.4 TSI; 1.6; 1.6 LPG; 1.6 TDI; 1.9 TDI; 2.0; 2.0 TDI	mar-08	giu-17	7	AB6024AT	-	Meccatronica: VW G004000 Cambio: VW G052171
SEAT	IBIZA IV (6J5, 6P1)	1.6	lug-15	giu-17	6	AB6138AT *	AB6139AT *	VW G055025A2
SEAT	IBIZA IV Furgone/hatchback (6J1)	1.2; 1.2 TDI; 1.6 TDI	apr-08	mag-15	7	AB6024AT	-	Meccatronica: VW G004000 Cambio: VW G052171
SEAT	IBIZA IV SC (6J1, 6P5)	1.0; 1.0 TSI; 1.2; 1.2 TDI; 1.2 TSI; 1.4; 1.4 LPG; 1.4 TDI; 1.4 TSI; 1.4 TSI Cupra; 1.6; 1.6 LPG; 1.6 TDI; 1.8 TSI Cupra; 1.9 TDI; 2.0; 2.0 TDI	giu-08	dic-16	7	AB6024AT	-	Meccatronica: VW G004000 Cambio: VW G052171
SEAT	IBIZA IV SC (6J1, 6P5)	1.6	lug-15	dic-16	6	AB6138AT *	AB6139AT *	VW G055025A2
SEAT	IBIZA IV ST (6J8, 6P8)	1.0; 1.0 TSI; 1.2; 1.2 TDI; 1.2 TSI; 1.4; 1.4 TDI; 1.4 TSI; 1.6; 1.6 TDI	mar-10	lug-16	7	AB6024AT	-	Meccatronica: VW G004000 Cambio: VW G052171
SEAT	IBIZA V (KJ1, KJG)	1.0; 1.0 MPI; 1.0 TGI; 1.0 TSI; 1.5 TSI; 1.6; 1.6 TDI	gen-17	In produzione	7	AB6024AT	-	Meccatronica: VW G004000 Cambio: VW G052171
SEAT	IBIZA V (KJ1, KJG)	1.6	mag-17	In produzione	6	AB6138AT *	AB6139AT *	VW G055025A2
SEAT	LEON (1M1)	1.4 16V; 1.6; 1.6 16 V; 1.8 20V; 1.8 20V T; 1.8 20V T 4; 1.8 T Cupra R; 1.9 SDI; 1.9 TDI; 1.9 TDI Syncro; 2.8 Cupra 4	nov-99	giu-06	4	AB6134AT	-	VW G052162A2 + 75W90 GL4
SEAT	LEON (1P1)	1.4 TSI; 1.8 TSI; 1.9 TDI; 2.0 TDI; 2.0 TDI 16V; 2.0 TFSI	mag-05	dic-12	6	AB6025AT + AB6027AT	-	VW G052182
SEAT	LEON (1P1)	1.6	mar-01	ott-05	4	AB6101AT	-	PSA 97.36.22
SEAT	LEON (1P1)	1.6; 1.6 TDI; 1.8 TSI	lug-05	dic-12	7	AB6024AT	-	Meccatronica: VW G004000 Cambio: VW G052171
SEAT	LEON (1P1)	1.9 TDI; 2.0 TDI; 2.0 TDI 16V; 2.0 TFSI	mag-05	dic-12	6	AB6025AT + AB6026AT	-	VW G052182
SEAT	LEON (1P1)	2.0 FSI; 2.0 TFSI	mag-05	dic-12	6	AB6137AT	-	VW G055025A2
SEAT	LEON (5F1)	1.0 TSI; 1.2 TSI; 1.4 TGI; 1.4 TSI; 1.6 TDI; 1.8 TSI; 2.0 Cupra; 2.0 Cupra R; 2.0 TDI	set-12	ago-20	7	AB6024AT	-	Meccatronica: VW G004000 Cambio: VW G052171
SEAT	LEON (5F1)	1.4 TGI; 1.4 TSI; 1.6 TDI; 1.8 TSI; 2.0 Cupra; 2.0 TDI	set-12	ago-20	6	AB6025AT + AB6026AT	-	VW G052182
SEAT	LEON (5F1)	1.8 TSI; 2.0 Cupra	feb-13	ago-20	6	AB6138AT *	AB6139AT *	VW G055025A2
SEAT	LEON (5F1)	1.8 TSI; 2.0 TDI	set-12	ago-20	6	AB6025AT + AB6027AT	-	VW G052182
SEAT	LEON Furgone/hatchback (5F1)	1.2 TSI; 1.6 TDI; 2.0 TDI	set-12	ago-18	7	AB6024AT	-	Meccatronica: VW G004000 Cambio: VW G052171
SEAT	LEON Furgone/hatchback (5F1)	2.0 TDI	ott-12	ago-18	6	AB6025AT + AB6026AT	-	VW G052182
SEAT	LEON SC (5F5)	1.0 TSI; 1.2 TSI; 1.4 TSI; 1.6 TDI; 1.8 TSI; 2.0 Cupra; 2.0 TDI	gen-13	ago-18	7	AB6024AT	-	Meccatronica: VW G004000 Cambio: VW G052171
SEAT	LEON SC (5F5)	1.8 TSI; 2.0 Cupra	feb-13	ago-18	6	AB6138AT *	AB6139AT *	VW G055025A2
SEAT	LEON SC (5F5)	1.8 TSI; 2.0 Cupra; 2.0 TDI	feb-13	ago-18	6	AB6025AT + AB6026AT	-	VW G052182

Marca / Brand:	Modello / Model:	Versioni / Version:	Da anno / From:	Ad anno / To:	Marce / Gears:	Codice AB PARTS		Lubrificante Consigliato
SEAT	LEON ST (5F8)	1.0 TSI; 1.2 TSI; 1.4 TGI; 1.4 TSI; 1.6 TDI; 1.6 TDI 4Drive; 1.8 TSI; 1.8 TSI 4Drive; 2.0 Cupra; 2.0 Cupra 4Drive; 2.0 TDI; 2.0 TDI 4Drive	set-12	ago-20	7	AB6024AT	-	Meccatronica: VW G004000 Cambio: VW G052171
SEAT	LEON ST (5F8)	1.4 TGI; 1.6 TDI; 1.8 TSI; 1.8 TSI 4Drive; 2.0 Cupra; 2.0 Cupra 4Drive; 2.0 TDI; 2.0 TDI 4Drive	ago-13	ago-20	6	AB6025AT + AB6026AT	-	VW G052182
SEAT	LEON ST (5F8)	1.8 TSI; 1.8 TSI 4Drive; 2.0 Cupra	ott-13	ago-20	6	AB6138AT *	AB6139AT *	VW G055025A2
SEAT	LEON ST Furgone/familiare (5F8)	1.2 TSI; 1.8 TFSI; 2.0 Cupra 4Drive; 2.0 TDI 4Drive	ott-13	ago-18	7	AB6024AT	-	Meccatronica: VW G004000 Cambio: VW G052171
SEAT	LEON ST Furgone/familiare (5F8)	1.8 TFSI	ott-13	ago-18	6	AB6138AT *	AB6139AT *	VW G055025A2
SEAT	LEON ST Furgone/familiare (5F8)	1.8 TFSI; 2.0 Cupra 4Drive	ott-13	ago-18	6	AB6025AT + AB6026AT	-	VW G052182
SEAT	TOLEDO I (1L2)	1.6 i; 1.8 16V; 1.8 i; 1.9 D; 1.9 TD; 1.9 TDI; 2.0 i; 2.0 i 16V	mag-91	mar-99	4	AB6134AT	-	VW G052162A2 + 75W90 Gl4
SEAT	TOLEDO III (5P2)	1.4 TSI; 1.8 TFSI	gen-07	mag-09	7	AB6024AT	-	Meccatronica: VW G004000 Cambio: VW G052171
SEAT	TOLEDO III (5P2)	1.8 TFSI; 1.9 TDI; 2.0 TDI; 2.0 TDI 16V; 2.0 TFSI	apr-04	mag-09	6	AB6025AT + AB6027AT	-	VW G052182
SEAT	TOLEDO III (5P2)	1.9 TDI; 2.0 TDI; 2.0 TDI 16V; 2.0 TFSI	apr-04	mag-09	6	AB6025AT + AB6026AT	-	VW G052182
SEAT	TOLEDO III (5P2)	2.0 FSI; 2.0 TFSI	ott-04	mag-09	6	AB6137AT	-	VW G055025A2
SEAT	TOLEDO IV (KG3)	1.0 TSI; 1.2 TSI; 1.4 TDI; 1.4 TSI; 1.6 TDI	lug-12	apr-19	7	AB6024AT	-	Meccatronica: VW G004000 Cambio: VW G052171
SEAT	TOLEDO IV (KG3)	1.6	mag-15	apr-19	6	AB6138AT *	AB6139AT *	VW G055025A2
SKODA	FABIA I (6Y2)	1.4 16V	dic-99	mar-08	4	AB6069AT	-	AISIN ATF-0T4
SKODA	FABIA I Combi (6Y5)	1.4 16V	mag-00	dic-07	4	AB6069AT	-	AISIN ATF-0T4
SKODA	FABIA I Praktik (6Y5)	1.4	lug-01	mag-03	7	AB6024AT	-	Meccatronica: VW G004000 Cambio: VW G052171
SKODA	FABIA I Praktik (6Y5)	1.4	mag-04	dic-07	4	AB6069AT	-	AISIN ATF-0T4
SKODA	FABIA I Tre volumi (6Y3)	1.4 16V	ott-99	dic-07	4	AB6069AT	-	AISIN ATF-0T4
SKODA	FABIA II (542)	1.2; 1.2 12V; 1.2 LPG; 1.2 TDI; 1.2 TSI; 1.4; 1.4 LPG; 1.4 TSI RS; 1.6; 1.6 TDI	gen-07	dic-14	7	AB6024AT	-	Meccatronica: VW G004000 Cambio: VW G052171
SKODA	FABIA II (542)	1.2; 1.4; 1.4 TDI; 1.6; 1.9 TDI	dic-06	dic-14	6	AB6136AT	-	VW G055025A2
SKODA	FABIA II Combi (545)	1.2; 1.2 12V; 1.2 LPG; 1.2 TDI; 1.2 TSI; 1.4; 1.4 LPG; 1.4 TSI RS; 1.6; 1.6 TDI	ott-07	dic-14	7	AB6024AT	-	Meccatronica: VW G004000 Cambio: VW G052171
SKODA	FABIA II Combi (545)	1.2; 1.4; 1.4 TDI; 1.6; 1.9 TDI	ott-07	dic-14	6	AB6136AT	-	VW G055025A2
SKODA	FABIA II Praktik (545)	TDI	ott-13	nov-14	7	AB6024AT	-	Meccatronica: VW G004000 Cambio: VW G052171
SKODA	FABIA III (NJ3)	1.0; 1.0 TSI; 1.2 TSI; 1.4 TDI; 1.4 TSI RS; 1.6	ago-14	giu-21	7	AB6024AT	-	Meccatronica: VW G004000 Cambio: VW G052171
SKODA	FABIA III (NJ3)	1.6	gen-15	giu-21	6	AB6138AT *	AB6139AT *	VW G055025A2

Marca / Brand:	Modello / Model:	Versioni / Version:	Da anno / From:	Ad anno / To:	Marce / Gears:	Codice AB PARTS		Lubrificante Consigliato
SKODA	FABIA III Familiare (NJ5)	1.0; 1.0 TSI; 1.2 TSI; 1.4 TDI; 1.6	ago-14	dic-22	7	AB6024AT	-	Meccatronica: VW G004000 Cambio: VW G052171
SKODA	FABIA III Familiare (NJ5)	1.6	gen-15	dic-22	6	AB6138AT *	AB6139AT *	VW G055025A2
SKODA	FABIA III Praktik (NJ5)	1.0; 1.2 TSI; 1.4 TDI	ott-14	dic-22	7	AB6024AT	-	Meccatronica: VW G004000 Cambio: VW G052171
SKODA	KAMIQ (NW4)	1.0 TSI	lug-19	In produzione	7	AB6024AT	-	Meccatronica: VW G004000 Cambio: VW G052171
SKODA	KAROQ (NU7, ND7)	1.0 TSI; 1.5 TSI; 1.5 TSI 4x4; 1.6 TDI; 2.0 TDI; 2.0 TDI 4x4	lug-17	In produzione	7	AB6024AT	-	Meccatronica: VW G004000 Cambio: VW G052171
SKODA	KODIAQ I (NS6, NS7, NV7)	1.4 TSI; 1.4 TSI 4x4	ott-16	In produzione	6	AB6025AT + AB6026AT	-	VW G052182
SKODA	OCTAVIA I (1U2)	1.4; 1.4 16V; 1.6; 1.8; 1.8 T; 1.8 T 4x4; 1.9 SDI; 1.9 TDI; 2.0; RS 1.8 T	set-96	dic-10	4	AB6134AT	-	VW G052162A2 + 75W90 Gl4
SKODA	OCTAVIA I Combi (1U5)	1.4 16V; 1.6; 1.8 20V; 1.8 T; 1.8 T 4x4; 1.9 SDI; 1.9 TDI; 1.9 TDI 4x4; 2.0; 2.0 4x4; RS 1.8 T	lug-98	dic-10	4	AB6134AT	-	VW G052162A2 + 75W90 Gl4
SKODA	OCTAVIA I Furgone/familiare (1U5)	1.9 D; 1.9 TDI	ago-00	mar-10	4	AB6134AT	-	VW G052162A2 + 75W90 Gl4
SKODA	OCTAVIA II (1Z3)	1.2 TSI; 1.4; 1.4 TSI; 1.6; 1.6 FSI; 1.6 LPG; 1.6 MultiFuel; 1.6 TDI; 1.8 TSI; 1.9 TDI; 2.0 TDI; 2.0 TDI 16V; 2.0 TDI RS; 2.0 TFSI	feb-04	giu-13	7	AB6024AT	-	Meccatronica: VW G004000 Cambio: VW G052171
SKODA	OCTAVIA II (1Z3)	1.4 TSI; 1.8 TSI; 1.9 TDI; 2.0 TDI; 2.0 TDI 16V; 2.0 TDI RS; 2.0 TFSI	feb-04	giu-13	6	AB6025AT + AB6027AT	-	VW G052182
SKODA	OCTAVIA II (1Z3)	1.4; 1.6; 1.6 FSI; 1.9 TDI; 2.0 FSI; 2.0 TDI; 2.0 TDI 16V; 2.0 TFSI	feb-04	giu-13	6	AB6136AT	-	VW G055025A2
SKODA	OCTAVIA II (1Z3)	1.6; 1.6 FSI; 1.8 TSI; 1.9 TDI; 2.0 FSI; 2.0 TDI; 2.0 TDI 16V; 2.0 TDI RS; 2.0 TFSI	feb-04	giu-13	6	AB6025AT + AB6026AT	-	VW G052182
SKODA	OCTAVIA II (1Z3)	1.6; 1.6 LPG; 1.6 MultiFuel; 1.8 TSI; 2.0 TFSI	giu-04	giu-13	6	AB6137AT	-	VW G055025A2
SKODA	OCTAVIA II Combi (1Z5)	1.2 TSI; 1.4; 1.4 TSI; 1.6; 1.6 FSI; 1.6 LPG; 1.6 MultiFuel; 1.6 TDI; 1.6 TDI 4x4; 1.8 TSI; 1.8 TSI 4x4; 1.9 TDI; 1.9 TDI 4x4; 2.0 TDI; 2.0 TDI 16V; 2.0 TDI 16V 4x4; 2.0 TDI 4x4; 2.0 TDI RS; 2.0 TFSI	feb-04	giu-13	7	AB6024AT	-	Meccatronica: VW G004000 Cambio: VW G052171
SKODA	OCTAVIA II Combi (1Z5)	1.4 TSI; 1.8 TSI; 1.8 TSI 4x4; 1.9 TDI; 1.9 TDI 4x4; 2.0 TDI; 2.0 TDI 16V; 2.0 TDI 16V 4x4; 2.0 TDI 4x4; 2.0 TDI RS; 2.0 TFSI	feb-04	giu-13	6	AB6025AT + AB6027AT	-	VW G052182
SKODA	OCTAVIA II Combi (1Z5)	1.4; 1.6; 1.6 FSI; 1.9 TDI; 1.9 TDI 4x4; 2.0 FSI; 2.0 FSI 4x4; 2.0 TDI; 2.0 TDI 16V; 2.0 TDI 4x4; 2.0 TFSI	feb-04	giu-13	6	AB6136AT	-	VW G055025A2
SKODA	OCTAVIA II Combi (1Z5)	1.6; 1.6 FSI; 1.8 TSI; 1.9 TDI; 2.0 FSI; 2.0 TDI; 2.0 TDI 16V; 2.0 TDI 16V 4x4; 2.0 TDI RS; 2.0 TFSI	feb-04	giu-13	6	AB6025AT + AB6026AT	-	VW G052182
SKODA	OCTAVIA II Combi (1Z5)	1.6; 1.6 LPG; 1.6 MultiFuel; 1.8 TSI; 1.8 TSI 4x4; 2.0 TFSI	set-04	giu-13	6	AB6137AT	-	VW G055025A2
SKODA	OCTAVIA III (5E3, NL3, NR3)	1.8 TSI; 2.0 TDI	nov-12	ott-20	6	AB6025AT + AB6027AT	-	VW G052182
SKODA	OCTAVIA III (5E3, NL3, NR3)	2.0 TDI 4x4; 1.0 TSI; 1.2 TSI; 1.4 TSI; 1.4 TSI G-TEC; 1.5 TSI; 1.6; 1.6 TDI; 1.6 TDI 4x4; 1.8 TSI; 1.8 TSI 4x4; 2.0 TDI; 2.0 TDI RS; 2.0 TSI; 2.0 TSI 4x4; 2.0 TSI RS	nov-12	ott-20	7	AB6024AT	-	Meccatronica: VW G004000 Cambio: VW G052171
SKODA	OCTAVIA III (5E3, NL3, NR3)	2.0 TDI 4x4; 1.0 TSI; 1.2 TSI; 1.4 TSI; 1.6; 1.6 TDI; 1.8 TSI; 1.8 TSI 4x4; 2.0 TDI; 2.0 TDI RS; 2.0 TSI RS	nov-12	ott-20	6	AB6025AT + AB6026AT	-	VW G052182
SKODA	OCTAVIA III (5E3, NL3, NR3)	2.0 TDI 4x4; 1.6; 1.8 TSI; 1.8 TSI 4x4; 2.0 TDI; 2.0 TDI RS; 2.0 TSI RS	nov-12	ott-20	6	AB6138AT *	AB6139AT *	VW G055025A2
SKODA	OCTAVIA III (5E3, NL3, NR3)	2.0 TDI 4x4; 1.6; 2.0 TDI; 2.0 TDI RS; 2.0 TSI RS	nov-12	ott-20	6	AB6139AT	-	VW G055025A2

Marca / Brand:	Modello / Model:	Versioni / Version:	Da anno / From:	Ad anno / To:	Marce / Gears:	Codice AB PARTS		Lubrificante Consigliato
SKODA	OCTAVIA III Combi (5E5, 5E6)	1.8 TSI; 2.0 TDI	nov-12	ott-20	6	AB6025AT + AB6027AT	-	VW G052182
SKODA	OCTAVIA III Combi (5E5, 5E6)	2.0 TDI 4x4; 1.0 TSI; 1.2 TSI; 1.4 TSI; 1.4 TSI G-TEC; 1.5 TSI; 1.5 TSI G-TEC; 1.6 SRE; 1.6 TDI; 1.6 TDI 4x4; 1.8 TSI; 1.8 TSI 4x4; 2.0 TDI; 2.0 TDI RS; 2.0 TSI; 2.0 TSI 4x4; 2.0 TSI RS	nov-12	ott-20	7	AB6024AT	-	Meccatronica: VW G004000 Cambio: VW G052171
SKODA	OCTAVIA III Combi (5E5, 5E6)	2.0 TDI 4x4; 1.0 TSI; 1.2 TSI; 1.4 TSI; 1.4 TSI G-TEC; 1.6 SRE; 1.6 TDI; 1.8 TSI; 1.8 TSI 4x4; 2.0 TDI; 2.0 TDI RS; 2.0 TSI RS	nov-12	ott-20	6	AB6025AT + AB6026AT	-	VW G052182
SKODA	OCTAVIA III Combi (5E5, 5E6)	2.0 TDI 4x4; 1.6 SRE; 1.8 TSI; 1.8 TSI 4x4; 2.0 TDI; 2.0 TDI RS; 2.0 TSI RS	nov-12	ott-20	6	AB6138AT *	AB6139AT *	VW G055025A2
SKODA	OCTAVIA III Combi (5E5, 5E6)	2.0 TDI 4x4; 1.6 SRE; 2.0 TDI; 2.0 TDI RS; 2.0 TSI RS	nov-12	ott-20	6	AB6139AT	-	VW G055025A2
SKODA	RAPID (NH3, NK3, NK6)	1.0 TSI; 1.2; 1.2 LPG; 1.2 TSI; 1.4 TDI; 1.4 TSI; 1.6; 1.6 SRE; 1.6 TDI	lug-12	mar-22	7	AB6024AT	-	Meccatronica: VW G004000 Cambio: VW G052171
SKODA	RAPID Spaceback (NH1)	1.0 TSI; 1.2; 1.2 TSI; 1.4 TDI; 1.4 TSI; 1.6; 1.6 SRE; 1.6 TDI	lug-12	dic-19	7	AB6024AT	-	Meccatronica: VW G004000 Cambio: VW G052171
SKODA	ROOMSTER (5J7)	1.2; 1.2 LPG; 1.2 TDI; 1.2 TSI; 1.4; 1.4 LPG; 1.6; 1.6 LPG; 1.6 TDI	giu-06	mag-15	7	AB6024AT	-	Meccatronica: VW G004000 Cambio: VW G052171
SKODA	ROOMSTER (5J7)	1.2; 1.4; 1.4 TDI; 1.6; 1.9 TDI	mag-06	mag-15	6	AB6136AT	-	VW G055025A2
SKODA	ROOMSTER Praktik (5J)	1.2; 1.2 TDI; 1.2 TSI; 1.4; 1.6 TDI	mar-07	mag-15	7	AB6024AT	-	Meccatronica: VW G004000 Cambio: VW G052171
SKODA	ROOMSTER Praktik (5J)	1.2; 1.4; 1.4 TDI	mar-07	mag-15	6	AB6136AT	-	VW G055025A2
SKODA	SCALA (NW1)	1.0 TSI; 1.5 TSI; 1.6 TDI	feb-19	In produzione	7	AB6024AT	-	Meccatronica: VW G004000 Cambio: VW G052171
SKODA	SUPERB I (3U4)	1.8 T; 1.9 TDI; 2.0; 2.0 TDI; 2.5 TDI; 2.8 V6	dic-01	mar-08	5	AB6149AT	-	ESSO LT 71141
SKODA	SUPERB II (3T4)	1.4 TSI; 1.6 TDI; 1.8 TSI; 1.8 TSI 4x4; 1.9 TDI; 2.0 TDI; 2.0 TDI 16V; 2.0 TDI 16V 4x4; 2.0 TDI 4x4; 2.0 TFSI; 3.6 FSI 4x4	mar-08	mag-15	7	AB6024AT	-	Meccatronica: VW G004000 Cambio: VW G052171
SKODA	SUPERB II (3T4)	1.4 TSI; 1.8 TSI; 1.8 TSI 4x4; 1.9 TDI; 2.0 TDI; 2.0 TDI 16V; 2.0 TDI 16V 4x4; 2.0 TDI 4x4; 2.0 TFSI; 3.6 FSI 4x4	mar-08	mag-15	6	AB6025AT + AB6027AT	-	VW G052182
SKODA	SUPERB II (3T4)	1.8 TSI; 2.0 TDI; 2.0 TDI 16V; 2.0 TDI 16V 4x4; 2.0 TDI 4x4; 2.0 TFSI; 3.6 FSI 4x4	mar-08	mag-15	6	AB6025AT + AB6026AT	-	VW G052182
SKODA	SUPERB II (3T4)	2.0 TFSI	mag-10	mag-15	6	AB6137AT	-	VW G055025A2
SKODA	SUPERB II Familiare (3T5)	1.4 TSI; 1.6 TDI; 1.8 TSI; 1.8 TSI 4x4; 1.9 TDI; 2.0 TDI; 2.0 TDI 16V; 2.0 TDI 16V 4x4; 2.0 TDI 4x4; 2.0 TFSI; 3.6 V6 4x4	ott-09	mag-15	7	AB6024AT	-	Meccatronica: VW G004000 Cambio: VW G052171
SKODA	SUPERB II Familiare (3T5)	1.4 TSI; 1.8 TSI; 1.8 TSI 4x4; 1.9 TDI; 2.0 TDI; 2.0 TDI 16V; 2.0 TDI 16V 4x4; 2.0 TDI 4x4; 2.0 TFSI; 3.6 V6 4x4	ott-09	mag-15	6	AB6025AT + AB6027AT	-	VW G052182
SKODA	SUPERB II Familiare (3T5)	1.8 TSI; 2.0 TDI; 2.0 TDI 16V; 2.0 TDI 16V 4x4; 2.0 TDI 4x4; 2.0 TFSI; 3.6 V6 4x4	ott-09	mag-15	6	AB6025AT + AB6026AT	-	VW G052182
SKODA	SUPERB II Familiare (3T5)	2.0 TFSI	mag-10	mag-15	6	AB6137AT	-	VW G055025A2
SKODA	SUPERB III (3V3)	1.4 TSI; 1.4 TSI 4x4; 1.5 TSI; 1.6 TDI; 1.8 TSI; 2.0 TDI; 2.0 TDI 4x4; 2.0 TSI; 2.0 TSI 4x4	mar-15	In produzione	7	AB6024AT	-	Meccatronica: VW G004000 Cambio: VW G052171
SKODA	SUPERB III (3V3)	2.0 TDI; 2.0 TDI 4x4; 2.0 TSI; 2.0 TSI 4x4	mar-15	In produzione	6	AB6025AT + AB6026AT	-	VW G052182

Marca / Brand:	Modello / Model:	Versioni / Version:	Da anno / From:	Ad anno / To:	Marce / Gears:	Codice AB PARTS		Lubrificante Consigliato
SKODA	SUPERB III Familiare (3V5)	1.4 TSI; 1.4 TSI 4x4; 1.5 TSI; 1.6 TDI; 1.8 TSI; 2.0 TDI; 2.0 TDI 4x4; 2.0 TSI; 2.0 TSI 4x4	mar-15	In produzione	7	AB6024AT	-	Meccatronica: VW G004000 Cambio: VW G052171
SKODA	SUPERB III Familiare (3V5)	2.0 TDI; 2.0 TDI 4x4; 2.0 TSI; 2.0 TSI 4x4	mar-15	In produzione	6	AB6025AT + AB6026AT	-	VW G052182
SKODA	YETI (5L)	1.2 TSI; 1.4 TSI; 1.4 TSI 4x4; 1.6; 1.6 TDI; 1.8 TSI 4x4; 2.0 TDI; 2.0 TDI 4x4	apr-09	dic-17	7	AB6024AT	-	Meccatronica: VW G004000 Cambio: VW G052171
SKODA	YETI (5L)	1.4 TSI 4x4; 1.6; 1.8 TSI 4x4; 2.0 TDI 4x4	apr-09	dic-17	6	AB6025AT + AB6026AT	-	VW G052182
SKODA	YETI (5L)	1.4 TSI; 1.8 TSI 4x4; 2.0 TDI; 2.0 TDI 4x4	apr-09	dic-17	6	AB6025AT + AB6027AT	-	VW G052182
SKODA	YETI (5L)	1.6	apr-14	dic-17	6	AB6139AT	-	VW G055025A2
SSANGYONG	ACTYON I	2.0 Xdi; 2.3; 2.3 4x4; 200 Xdi 4WD	nov-05	giu-13	6	AB6017AT	-	FUCHS TITAN ATF3292
SSANGYONG	KYRON	2.0 Xdi; 2.0 Xdi 4x4; 2.3; 2.3 4x4; 2.7 Xdi 4x4; 3.2 M320 4x4	mag-05	dic-14	6	AB6017AT	-	FUCHS TITAN ATF3292
SSANGYONG	KYRON	2.0 Xdi; 2.0 Xdi 4x4; 2.7 Xdi 4x4; 3.2 M320 4x4	mag-05	dic-14	5	AB6078AT	-	MB 236.14
SSANGYONG	REXTON	2.0 Xdi; 2.0 Xdi AWD; 2.2 Xdi; 2.2 Xdi AWD; 2.7 Xdi AWD	lug-12	giu-17	6	AB6017AT	-	FUCHS TITAN ATF3292
SSANGYONG	REXTON (Y400, Y450)	2.2 Xdi; 2.2 Xdi AWD	lug-17	In produzione	5	AB6078AT	-	MB 236.14
SSANGYONG	REXTON (Y400, Y450)	2.2 Xdi; 2.2 Xdi AWD	lug-17	In produzione	7	AB6082AT	-	MB 236.21
SSANGYONG	REXTON / REXTON II (GAB_)	2.3 RX230 4x4; 2.7 D 4x4; 2.7 Xdi; 2.7 Xdi 4x4; 2.7 Xdi Turbo 4x4; 2.9 TD; 3.2 RX320 4x4	apr-02	In produzione	5	AB6078AT	-	MB 236.14
SSANGYONG	REXTON / REXTON II VAN	RX270 XDi 4x4	mar-11	apr-13	5	AB6078AT	-	MB 236.14
SSANGYONG	REXTON VAN (Y400)	e-XDi; e-XDi 4WD	lug-17	In produzione	5	AB6078AT	-	MB 236.14
SSANGYONG	REXTON VAN (Y400)	e-XDi; e-XDi 4WD	lug-17	In produzione	7	AB6082AT	-	MB 236.21
SSANGYONG	REXTON W / REXTON	2.0 Xdi; 2.0 Xdi AWD; 2.2 Xdi; 2.2 Xdi AWD; 2.7 Xdi AWD	lug-12	giu-17	5	AB6078AT	-	MB 236.14
SSANGYONG	REXTON W / REXTON VAN	e-XDi; e-XDi AWD	lug-15	In produzione	5	AB6078AT	-	MB 236.14
SSANGYONG	RODIUS I	2.7 Xdi; 2.7 Xdi 4WD; 3.2; 3.2 4WD	mag-05	In produzione	5	AB6078AT	-	MB 236.14
SSANGYONG	RODIUS II	2.0 Xdi; 2.0 Xdi 4WD	lug-13	In produzione	5	AB6078AT	-	MB 236.14
SSANGYONG	RODIUS II	2.2 Xdi; 2.2 Xdi 4WD	lug-15	In produzione	7	AB6082AT	-	MB 236.21
SSANGYONG	RODIUS II VAN (CA1)	e-XDi; e-XDi 4WD	lug-15	In produzione	7	AB6082AT	-	MB 236.21
SSANGYONG	STAVIC	2.0 200 XDi; 2.7 270 sXDi; 2.7 270 sXDi 4x4	feb-05	In produzione	5	AB6078AT	-	MB 236.14
SUBARU	FORESTER (SF_)	2.0 AWD; 2.0 S Turbo AWD	ago-97	set-02	4	AB6115AT + AB6116AT	-	SUBARU ATF-HP
SUBARU	FORESTER (SG_)	2.0 AWD; 2.0 S Turbo AWD; 2.5 AWD	feb-02	mag-05	4	AB6115AT + AB6116AT	-	SUBARU ATF-HP
SUBARU	FORESTER (SJ_)	2.0 i AWD; 2.0 XT AWD	mar-13	In produzione	CVT	AB6111AT + AB6114AT	-	SUBARU CVTF-II
SUBARU	FORESTER (SJ_)	2.0 i AWD; 2.5 AWD	nov-12	In produzione	CVT	AB6111AT + AB6112AT + AB6113AT	-	SUBARU CVTF-II
SUBARU	IMPREZA Coupé (GFC)	1.6; 1.6 AWD; 2.0 AWD; 2.0 Turbo AWD	dic-95	dic-00	4	AB6115AT + AB6116AT	-	SUBARU ATF-HP

Marca / Brand:	Modello / Model:	Versioni / Version:	Da anno / From:	Ad anno / To:	Marce / Gears:	Codice AB PARTS		Lubrificante Consigliato
SUBARU	IMPREZA Familiare (GF)	1.6 i; 1.6 i AWD; 1.8 i AWD; 2.0 i 16V AWD; 2.0 i AWD; 2.0 i Turbo AWD; 2.0 Turbo GT AWD	ago-92	dic-00	4	AB6115AT + AB6116AT	-	SUBARU ATF-HP
SUBARU	IMPREZA Familiare (GG)	1.5 AWD; 1.6 AWD; 2.0 AWD; 2.0 i R AWD; 2.0 Turbo AWD; 2.0 WRX Turbo AWD	dic-00	dic-07	4	AB6115AT + AB6116AT	-	SUBARU ATF-HP
SUBARU	IMPREZA Hatchback (GP_)	1.6 i; 1.6 i AWD; 2.0 AWD	gen-12	In produzione	CVT	AB6111AT + AB6112AT + AB6113AT	-	SUBARU CVTF-II
SUBARU	IMPREZA Tre volumi (GC)	1.6 i; 1.6 i AWD; 1.8 i AWD; 2.0 i AWD; 2.0 Turbo GT AWD	ago-92	dic-00	4	AB6115AT + AB6116AT	-	SUBARU ATF-HP
SUBARU	IMPREZA Tre volumi (GD)	1.5 AWD; 1.6 AWD; 2.0 i AWD; 2.0 i R AWD; 2.0 WRX Turbo AWD	dic-00	giu-09	4	AB6115AT + AB6116AT	-	SUBARU ATF-HP
SUBARU	IMPREZA Tre volumi (GJ_)	1.6 AWD; 1.6 Trazione anteriore; 2.0 AWD	lug-11	In produzione	CVT	AB6111AT + AB6112AT + AB6113AT	-	SUBARU CVTF-II
SUBARU	LEGACY III (BE)	2.0 AWD; 2.5 AWD	ott-98	ago-03	4	AB6115AT + AB6116AT	-	SUBARU ATF-HP
SUBARU	LEGACY III Familiare (BH)	2.0 AWD; 2.5 AWD	dic-98	ago-03	4	AB6115AT + AB6116AT	-	SUBARU ATF-HP
SUBARU	LEGACY V (BM)	2.5 GT AWD; 2.5 i AWD	set-09	dic-14	CVT	AB6111AT + AB6114AT	-	SUBARU CVTF-II
SUBARU	LEGACY V (BM)	2.5 i AWD	lug-12	dic-14	CVT	AB6111AT + AB6112AT + AB6113AT	-	SUBARU CVTF-II
SUBARU	LEGACY V Familiare (BR)	2.0 i AWD; 2.5 CNG AWD	giu-12	dic-14	CVT	AB6111AT + AB6112AT + AB6113AT	-	SUBARU CVTF-II
SUBARU	LEGACY V Familiare (BR)	2.5 CNG AWD; 2.5 GT AWD; 2.5 i AWD	mag-09	dic-14	CVT	AB6111AT + AB6114AT	-	SUBARU CVTF-II
SUBARU	OUTBACK (BR)	2.5 BiFuel AWD; 2.5 CNG AWD; 2.5 i AWD	gen-13	In produzione	CVT	AB6111AT + AB6112AT + AB6113AT	-	SUBARU CVTF-II
SUBARU	OUTBACK (BR)	2.5 BiFuel AWD; 2.5 CNG AWD; 2.5 i AWD; 3.6 AWD; 3.6 R AWD	set-09	In produzione	CVT	AB6111AT + AB6114AT	-	SUBARU CVTF-II
SUBARU	OUTBACK (BS)	2.5 AWD	mar-15	In produzione	CVT	AB6111AT + AB6112AT + AB6113AT	-	SUBARU CVTF-II
SUBARU	WRX Tre volumi (GJ)	2.0 AWD	set-13	In produzione	CVT	AB6111AT + AB6114AT	-	SUBARU CVTF-II

Marca / Brand:	Modello / Model:	Versioni / Version:	Da anno / From:	Ad anno / To:	Marce / Gears:	Codice AB PARTS		Lubrificante Consigliato
SUBARU	XV (_GP_)	1.6 BiFuel AWD; 1.6 i AWD; 2.0 BiFuel AWD; 2.0 i AWD	mar-12	In produzione	CVT	AB6111AT + AB6112AT + AB6113AT	-	SUBARU CVTF-II
SUZUKI	ALTO VII (GF)	1.0	gen-09	In produzione	4	AB6001AT	-	AISIN JWS 3309
SUZUKI	BALENO (EG)	1.6 i 16V; 1.8 GTX	lug-95	mag-02	4	AB6004AT	-	DEXRON II
SUZUKI	BALENO Familiare (EG)	1.6 i 16V; 1.8 i 16V	ago-96	mag-02	4	AB6004AT	-	DEXRON II
SUZUKI	BALENO Hatchback (EG)	1.6 i 16V; 1.8 GTX	lug-95	mag-02	4	AB6004AT	-	DEXRON II
SUZUKI	GRAND VITARA I (FT, HT)	1.6 4x4; 2.0 4x4; 2.0 HDI 110 16V 4x4; 2.0 HDI 110 4x4; 2.0 TD 4x4; 2.5 V6 24V 4x4; 2.7 4x4	mar-98	set-05	4	AB6003AT	-	DEXRON VI
SUZUKI	GRAND VITARA I Fuoristrada aperto (GT)	1.6 4x4; 2.0 4x4	mar-98	lug-03	4	AB6003AT	-	DEXRON VI
SUZUKI	IGNIS II (MH)	1.5	set-03	In produzione	4	AB6001AT	-	AISIN JWS 3309
SUZUKI	JIMNY Fuoristrada chiuso (A6G)	1.5 AllGrip	lug-18	In produzione	4	AB6117AT	-	DEXRON III
SUZUKI	JIMNY Fuoristrada chiuso (SN)	1.3; 1.3 16V; 1.3 16V 4WD; 1.3 16V 4x4; 1.3 4WD	set-98	In produzione	4	AB6117AT	-	DEXRON III
SUZUKI	LIANA (ER, RH_)	1.6 4WD; 1.6 i	apr-02	In produzione	4	AB6001AT	-	AISIN JWS 3309
SUZUKI	LIANA Hatchback	1.6; 1.6 4WD; 1.6 i	lug-01	dic-07	4	AB6001AT	-	AISIN JWS 3309
SUZUKI	SPLASH (EX)	1.2; 1.2 VVT	gen-08	In produzione	4	AB6001AT	-	AISIN JWS 3309
SUZUKI	SWIFT III (MZ, EZ)	1.3; 1.3 4x4; 1.5; 1.6	feb-05	In produzione	4	AB6001AT	-	AISIN JWS 3309
SUZUKI	SWIFT IV (FZ, NZ)	1.2; 1.6	ott-10	In produzione	4	AB6001AT	-	AISIN JWS 3309
SUZUKI	SX4 / SX4 CLASSIC (EY, GY)	1.5 VVT; 1.5 VVTi; 1.6 VVT; 1.6 VVT 4x4	giu-06	In produzione	4	AB6001AT	-	AISIN JWS 3309
SUZUKI	SX4 Tre volumi (GY, RW)	1.6	ott-07	In produzione	4	AB6001AT	-	AISIN JWS 3309
SUZUKI	VITARA (ET, TA, TD)	1.6 i 16V AWD; 1.6 AWD; 1.9 D AWD; 2.0 16V AWD; 2.0 TD Intercooler AWD; 2.0 TD AWD; 2.0 V6 24V AWD; 2.5 V6 24V AWD	lug-88	mar-98	4	AB6003AT	-	DEXRON VI
SUZUKI	VITARA Cabrio (ET, TA)	1.6; 1.6 i 16V; 1.9 D; 2.0 16V	lug-88	mar-99	4	AB6003AT	-	DEXRON VI
SUZUKI	WAGON R+ Hatchback (MM)	1.3	set-03	ago-06	4	AB6001AT	-	AISIN JWS 3309
TESLA	MODEL 3 (5YJ3)	EV, EV Performance	mar-18	In produzione	-	AB6118AT	-	DEXRON VI
TESLA	MODEL Y (5YJY)	EV, EV Performance	mar-19	In produzione	-	AB6118AT	-	DEXRON VI
TOYOTA	4 RUNNER IV (_N21_)	4.0; 4.0 4WD; 4.7 4WD	ago-02	dic-09	5	AB6122AT	-	Toyota ATF WS
TOYOTA	4 RUNNER V (_N28_)	4.0	gen-10	In produzione	5	AB6122AT	-	Toyota ATF WS
TOYOTA	ALPHARD / VELLFIRE (_H2_)	3.5; 3.5 4WD	apr-08	dic-14	6	AB6131AT	-	Toyota ATF WS
TOYOTA	AURION (_V4_)	3.5	mar-06	set-11	6	AB6131AT	-	Toyota ATF WS
TOYOTA	AURION (_V5_)	3.5	set-11	In produzione	6	AB6131AT	-	Toyota ATF WS
TOYOTA	AURIS (_E15_)	1.4; 1.4 D-4D; 1.6; 1.8; 1.8 Hybrid; 2.0 D-4D; 2.2 D	ott-06	set-12	CVT	AB6127AT + AB6128AT	-	Toyota CVT FLUID TC/FE
TOYOTA	AURIS (_E15_)	1.8	ott-06	set-12	CVT	AB6127AT + AB6129AT	-	Toyota CVT FLUID TC/FE
TOYOTA	AURIS (_E18_)	1.2; 1.6	ott-12	dic-18	CVT	AB6130AT	-	Toyota CVT FLUID FE
TOYOTA	AURIS (_E18_)	1.6	ott-12	dic-18	CVT	AB6127AT + AB6129AT	-	Toyota CVT FLUID TC/FE
TOYOTA	AURIS (_E18_)	1.8 Hybrid	ott-12	dic-18	CVT	AB6127AT + AB6128AT	-	Toyota CVT FLUID TC/FE
TOYOTA	AURIS Familiare (_E18_)	1.2; 1.6	lug-13	dic-18	CVT	AB6130AT	-	Toyota CVT FLUID FE

Marca / Brand:	Modello / Model:	Versioni / Version:	Da anno / From:	Ad anno / To:	Marce / Gears:	Codice AB PARTS		Lubrificante Consigliato
TOYOTA	AURIS Familiare (_E18_)	1.6	lug-13	dic-18	CVT	AB6127AT + AB6129AT	-	Toyota CVT FLUID TC/FE
TOYOTA	AURIS Familiare (_E18_)	1.6; 1.8 Hybrid	lug-13	dic-18	CVT	AB6127AT + AB6128AT	-	Toyota CVT FLUID TC/FE
TOYOTA	AVALON Tre volumi (_X3_)	3.5	gen-05	nov-12	6	AB6131AT	-	Toyota ATF WS
TOYOTA	AVALON Tre volumi (_X4_)	3.5	set-12	mar-18	6	AB6131AT	-	Toyota ATF WS
TOYOTA	AVENSIS (_T27_)	1.8 VVT-i	nov-08	ott-18	CVT	AB6127AT + AB6129AT	-	Toyota CVT FLUID TC/FE
TOYOTA	AVENSIS (_T27_)	2.0 VVT-i	nov-08	ott-18	CVT	AB6124AT	-	Toyota CVT FLUID FE
TOYOTA	AVENSIS Familiare (_T27_)	1.6 VVT-i; 1.8 VVT-i; 2.0 D-4D; 2.2 D-4D	nov-08	ott-18	CVT	AB6127AT + AB6128AT	-	Toyota CVT FLUID TC/FE
TOYOTA	AVENSIS Familiare (_T27_)	1.8 VVT-i	nov-08	ott-18	CVT	AB6130AT	-	Toyota CVT FLUID FE
TOYOTA	AVENSIS Familiare (_T27_)	2.2 D-4D	nov-08	ott-18	6	AB6131AT	-	Toyota ATF WS
TOYOTA	AVENSIS Tre volumi (_T27_)	1.6 VVT-i; 1.8 VVT-i; 2.0 D-4D; 2.0 VVT-i; 2.2 D-4D	nov-08	ott-18	CVT	AB6127AT + AB6128AT	-	Toyota CVT FLUID TC/FE
TOYOTA	AVENSIS Tre volumi (_T27_)	1.8 VVT-i	nov-08	ott-18	CVT	AB6130AT	-	Toyota CVT FLUID FE
TOYOTA	AVENSIS Tre volumi (_T27_)	2.2 D-4D	nov-08	ott-18	6	AB6131AT	-	Toyota ATF WS
TOYOTA	bB I (NCP3_)	1.3	gen-00	nov-05	4	AB6001AT	-	AISIN JWS 3309
TOYOTA	CAMRY (_V7_, _VA7_, _VH7_)	2.0; 2.5; 2.5 Hybrid; 3.5	ago-17	In produzione	CVT	AB6125AT + AT3126AT	-	Toyota CVT FLUID FE
TOYOTA	CAMRY Tre volumi (_V4_)	3.5	gen-06	dic-14	6	AB6131AT	-	Toyota ATF WS
TOYOTA	CAMRY Tre volumi (_V5_)	3.5	set-11	mar-18	6	AB6131AT	-	Toyota ATF WS
TOYOTA	C-HR (_X1_)	1.2; 1.2 4WD; 1.8 Hybrid; 2.0 Hybrid	ott-16	In produzione	CVT	AB6130AT	-	Toyota CVT FLUID FE
TOYOTA	C-HR (_X1_)	1.2; 1.2 4WD; 1.8 Hybrid; 2.0; 2.0 Hybrid	ott-16	In produzione	CVT	AB6125AT + AT3126AT	-	Toyota CVT FLUID FE
TOYOTA	C-HR VAN (_X1_)	1.8 Hybrid	ott-16	In produzione	CVT	AB6125AT + AT3126AT	-	Toyota CVT FLUID FE
TOYOTA	COROLLA Familiare (_E21_)	1.2	feb-19	In produzione	CVT	AB6130AT	-	Toyota CVT FLUID FE
TOYOTA	COROLLA Familiare (_E21_)	1.2; 1.8 Hybrid; 2.0 Hybrid	feb-19	In produzione	CVT	AB6125AT + AT3126AT	-	Toyota CVT FLUID FE
TOYOTA	COROLLA Hatchback (_E21_, _EA1_, _EH1_)	1.2	gen-19	In produzione	CVT	AB6130AT	-	Toyota CVT FLUID FE
TOYOTA	COROLLA Hatchback (_E21_, _EA1_, _EH1_)	1.2; 1.8 Hybrid; 2.0 Hybrid	ott-18	In produzione	CVT	AB6125AT + AT3126AT	-	Toyota CVT FLUID FE
TOYOTA	COROLLA Tre volumi (_E15_)	1.8	ott-06	lug-14	CVT	AB6127AT + AB6129AT	-	Toyota CVT FLUID TC/FE
TOYOTA	COROLLA Tre volumi (_E18_, ZRE1_)	1.6	giu-13	dic-18	CVT	AB6127AT + AB6129AT	-	Toyota CVT FLUID TC/FE
TOYOTA	COROLLA Tre volumi (_E18_, ZRE1_)	1.6; 1.8 VVTi	giu-13	ago-19	CVT	AB6130AT	-	Toyota CVT FLUID FE
TOYOTA	COROLLA Tre volumi (_E18_, ZRE1_)	1.8 VVTi	giu-13	ago-19	CVT	AB6127AT + AB6129AT	-	Toyota CVT FLUID TC/FE

Marca / Brand:	Modello / Model:	Versioni / Version:	Da anno / From:	Ad anno / To:	Marce / Gears:	Codice AB PARTS		Lubrificante Consigliato
TOYOTA	COROLLA Tre volumi (_E21_)	1.6 VVTi	gen-19	In produzione	CVT	AB6130AT	-	Toyota CVT FLUID FE
TOYOTA	COROLLA Tre volumi (_E21_)	1.6 VVTi; 1.8 VVTi Hybrid	gen-19	In produzione	CVT	AB6125AT + AT3126AT	-	Toyota CVT FLUID FE
TOYOTA	COROLLA Tre volumi (_E21_)	1.8 VVTi	gen-19	In produzione	CVT	AB6127AT + AB6129AT	-	Toyota CVT FLUID TC/FE
TOYOTA	COROLLA Verso (ZER_, ZZE12_, R1_)	1.6; 1.8; 2.0 D-4D; 2.2 D-4D	apr-04	mar-09	CVT	AB6127AT + AB6128AT	-	Toyota CVT FLUID TC/FE
TOYOTA	ECHO Tre volumi (_P1_)	1.3	apr-03	ago-05	4	AB6001AT	-	AISIN JWS 3309
TOYOTA	FJ CRUISER (GSJ1_)	4.0; 4.0 4WD	giu-05	In produzione	5	AB6122AT	-	Toyota ATF WS
TOYOTA	FORTUNER (_N5_, _N6_)	2.5 D-4D; 3.0 D; 3.0 D 4WD; 4.0; 4.0 4WD	giu-04	mag-15	5	AB6122AT	-	Toyota ATF WS
TOYOTA	HIACE IV Autobus (_H1_, _H2_)	2.7; 2.7 4WD	apr-98	ago-06	4	AB6003AT	-	DEXRON VI
TOYOTA	HIACE IV Autobus (_H1_)	2.4	ago-89	ago-03	4	AB6003AT	-	DEXRON VI
TOYOTA	HIACE IV Furgone (_H1_, _H2_)	2.7; 2.7 4WD	apr-98	giu-05	4	AB6003AT	-	DEXRON VI
TOYOTA	HIACE IV Furgone (_H1_)	2.4	ago-89	ago-95	4	AB6003AT	-	DEXRON VI
TOYOTA	HIGHLANDER / KLUGER (_U5_)	3.5 AWD	set-14	nov-16	6	AB6131AT	-	Toyota ATF WS
TOYOTA	HILUX VII Pick-up (_N1_, _N2_, _N3_)	2.5 D-4D; 3.0 D; 3.0 D-4D 4WD	mar-05	set-15	5	AB6122AT	-	Toyota ATF WS
TOYOTA	LAND CRUISER 100 (_J1_)	4.2 TD	gen-98	ago-07	4	AB6121AT	-	Toyota ATF Type T-IV
TOYOTA	LAND CRUISER 100 (_J1_)	4.2 TD; 4.7	gen-98	ago-07	5	AB6122AT	-	Toyota ATF WS
TOYOTA	LAND CRUISER 200 (_J2_)	4.5 D V8; 4.5 D4-D; 4.6 V8	ago-07	In produzione	6	AB6123AT	-	Toyota ATF WS
TOYOTA	LAND CRUISER 200 (_J2_)	4.7 V8	gen-08	In produzione	5	AB6122AT	-	Toyota ATF WS
TOYOTA	LAND CRUISER PRADO (_J12_)	3.0 D-4D; 4.0; 4.0 V6 VVT-i	set-02	dic-10	5	AB6122AT	-	Toyota ATF WS
TOYOTA	LAND CRUISER PRADO (_J15_)	3.0 D-4D; 4.0 V6 Dual VVTi; 4.0 V6 VVTi; 4.0 V6 VVT-i	ago-09	In produzione	5	AB6122AT	-	Toyota ATF WS
TOYOTA	MARK X ZIO I (_A1_)	3.5	set-07	In produzione	6	AB6131AT	-	Toyota ATF WS
TOYOTA	PLATZ (NCP1_, SCP1_)	1.0	apr-99	ago-05	4	AB6001AT	-	AISIN JWS 3309
TOYOTA	PORTE I (_NNP1_)	1.3 VVTi	lug-04	lug-12	4	AB6001AT	-	AISIN JWS 3309
TOYOTA	PREVIA I (_R1_, _R2_)	2.4; 2.4 4WD	gen-90	ago-00	4	AB6003AT	-	DEXRON VI
TOYOTA	RAV 4 III (_A3_)	2.2 D 4WD	feb-06	giu-13	6	AB6131AT	-	Toyota ATF WS
TOYOTA	RAV 4 IV (_A4_)	2.0 VVT-i AWD	dic-12	ott-18	CVT	AB6124AT	-	Toyota CVT FLUID FE
TOYOTA	RAV 4 IV (_A4_)	2.2 D 4WD	dic-12	set-19	6	AB6131AT	-	Toyota ATF WS
TOYOTA	RAV 4 IV VAN (_A4_)	2.2 D4d 4WD	dic-12	nov-18	6	AB6131AT	-	Toyota ATF WS
TOYOTA	RAV 4 V (_A5_, _H5_)	2.0; 2.0 AWD; 2.0 VVTi; 2.0 VVTi AWD	dic-18	In produzione	CVT	AB6125AT + AT3126AT	-	Toyota CVT FLUID FE
TOYOTA	RAV 4 V VAN (_A5_, _H5_)	2.0 VVTi; 2.0 VVTi AWD	dic-18	In produzione	CVT	AB6125AT + AT3126AT	-	Toyota CVT FLUID FE
TOYOTA	SEQUOIA (_K3_, _K4_)	4.7; 4.7 4WD	set-00	ott-07	5	AB6122AT	-	Toyota ATF WS
TOYOTA	SEQUOIA (_K6_)	4.7; 4.7 4WD	nov-07	apr-14	5	AB6122AT	-	Toyota ATF WS
TOYOTA	SEQUOIA (_K6_)	5.7; 5.7 4WD	nov-07	In produzione	6	AB6123AT	-	Toyota ATF WS
TOYOTA	SIENNA (_L3_)	3.5; 3.5 4WD	gen-10	In produzione	6	AB6131AT	-	Toyota ATF WS
TOYOTA	TACOMA Pick-up (_N2_)	4.0; 4.0 4WD	set-04	dic-15	5	AB6122AT	-	Toyota ATF WS
TOYOTA	TUNDRA Pick-up (_K3_, _K4_)	4.0; 4.7; 4.7 4WD	feb-99	nov-06	5	AB6122AT	-	Toyota ATF WS

Marca / Brand:	Modello / Model:	Versioni / Version:	Da anno / From:	Ad anno / To:	Marce / Gears:	Codice AB PARTS		Lubrificante Consigliato
TOYOTA	TUNDRA Pick-up (_K5_, _K6_)	4.0; 4.7; 4.7 4WD	nov-06	In produzione	5	AB6122AT	-	Toyota ATF WS
TOYOTA	TUNDRA Pick-up (_K5_, _K6_)	4.6; 5.7; 5.7 4WD; 5.7 Flexfuel 4WD	nov-06	In produzione	6	AB6123AT	-	Toyota ATF WS
TOYOTA	VENZA (_V1_)	3.5; 3.5 4WD	nov-08	nov-16	6	AB6131AT	-	Toyota ATF WS
TOYOTA	VERSO (_R2_)	1.8	apr-09	ago-18	CVT	AB6130AT	-	Toyota CVT FLUID FE
TOYOTA	VERSO (_R2_)	1.8 VVTi	apr-09	ago-18	CVT	AB6127AT + AB6129AT	-	Toyota CVT FLUID TC/FE
TOYOTA	VERSO (_R2_)	2.2 D-4D	apr-09	ago-18	6	AB6131AT	-	Toyota ATF WS
TOYOTA	VERSO VAN (_R2_)	1.8 VVTi	apr-09	ago-18	CVT	AB6127AT + AB6129AT	-	Toyota CVT FLUID TC/FE
TOYOTA	VERSO VAN (_R2_)	D4d	apr-09	ago-18	6	AB6131AT	-	Toyota ATF WS
TOYOTA	VERSO VAN (_R2_)	VVTi	apr-09	ago-18	CVT	AB6130AT	-	Toyota CVT FLUID FE
TOYOTA	WILL CYPHA I (NCP7_)	1.3 VVTi	mag-01	lug-05	4	AB6001AT	-	AISIN JWS 3309
TOYOTA	YARIS (_P1_)	1.0; 1.3; 1.3 4WD	apr-99	nov-05	4	AB6001AT	-	AISIN JWS 3309
TOYOTA	YARIS (_P13_)	1.5	mar-17	giu-20	CVT	AB6130AT	-	Toyota CVT FLUID FE
TOYOTA	YARIS (_P21_, _PA1_, _PH1_)	1.0; 1.5; 1.5 Hybrid; 1.6 GR 4WD	feb-20	In produzione	CVT	AB6125AT + AT3126AT	-	Toyota CVT FLUID FE
TOYOTA	YARIS (_P9_)	1.3 4WD; 1.3 VVT-i	nov-05	dic-12	4	AB6001AT	-	AISIN JWS 3309
TOYOTA	YARIS / VIOS Tre volumi (_P9_)	1.3; 1.3 4WD	set-05	apr-13	4	AB6001AT	-	AISIN JWS 3309
TOYOTA	YARIS CROSS (MXP_)	1.5	set-20	In produzione	CVT	AB6125AT + AT3126AT	-	Toyota CVT FLUID FE
TOYOTA	YARIS Furgone/hatchback (_P13_)	1.5 VVTi	mar-17	giu-20	CVT	AB6130AT	-	Toyota CVT FLUID FE
TOYOTA	YARIS VERSO (_P2_)	1.3	ago-99	set-05	4	AB6001AT	-	AISIN JWS 3309
VAUXHALL	ANTARA A (L07)	2.0 CDTi; 2.0 CDTi 4x4; 2.2 CDTi 4x4; 2.4 4x4; 2.4 LPG 4x4	ago-06	apr-15	6	AB6052AT	-	DEXRON VI
VAUXHALL	ASTRA Mk III (F) Cabriolet (T92)	1.6 i; 2.0 i; 2.0 i 16V	mar-93	mar-01	4	AB6004AT	-	DEXRON II
VAUXHALL	ASTRA Mk III (F) Familiare (T92)	1.4 i; 1.4 i 16V; 1.6 i; 1.6 i 16V; 1.6 Si; 2.0 i 16V	mar-91	dic-98	4	AB6004AT	-	DEXRON II
VAUXHALL	ASTRA Mk III (F) Hatchback (T92)	1.4 i; 1.4 i 16V; 1.6 i; 1.6 i 16V; 2.0 i 16V	set-91	feb-98	4	AB6004AT	-	DEXRON II
VAUXHALL	ASTRA Mk III (F) Tre volumi (T92)	1.4 i; 1.6 i; 1.6 i 16V; 2.0 i 16V	mar-92	set-98	4	AB6004AT	-	DEXRON II
VAUXHALL	ASTRA Mk IV (G) Cabriolet (T98)	2.2 16V	mar-01	ott-05	4	AB6004AT	-	DEXRON II
VAUXHALL	ASTRA Mk IV (G) Coupé (T98)	1.8 16V; 2.2 16V	mar-00	ago-05	4	AB6004AT	-	DEXRON II
VAUXHALL	ASTRA Mk IV (G) Familiare (T98)	1.6; 1.6 16V; 1.6 Dualfuel; 1.7 DTI 16V; 1.8 16V; 1.8 16V Dualfuel; 2.0 DI; 2.2 16V	feb-98	mag-05	4	AB6004AT	-	DEXRON II
VAUXHALL	ASTRA Mk IV (G) Hatchback (T98)	1.4 16V; 1.6; 1.6 16V; 1.7 DTI 16V; 1.8 16V; 2.0 DI; 2.2 16V	feb-98	mag-05	4	AB6004AT	-	DEXRON II
VAUXHALL	ASTRA Mk IV (G) Tre volumi (T98)	1.6; 1.6 16V; 1.7 DTI 16V; 1.8 16V; 1.8 16V Dualfuel; 2.0 DI	feb-98	mag-05	4	AB6004AT	-	DEXRON II
VAUXHALL	ASTRA Mk V (H) (A04)	1.6; 1.8; 1.9 CDTi; 1.9 CDTi 16V	gen-04	mag-09	4	AB6004AT	-	DEXRON II
VAUXHALL	ASTRA Mk V (H) Familiare (A04)	1.6; 1.8; 1.9 CDTi; 1.9 CDTi 16V	ago-04	mar-11	4	AB6004AT	-	DEXRON II
VAUXHALL	ASTRA Mk V (H) Sport Hatch (A04)	1.6; 1.6 i 16V; 1.8; 1.8 i 16V; 1.9 CDTi	feb-05	nov-10	4	AB6004AT	-	DEXRON II
VAUXHALL	ASTRA Mk V (H) TwinTop (A04)	1.6; 1.6 i 16V; 1.8	set-05	ago-11	4	AB6004AT	-	DEXRON II
VAUXHALL	ASTRA Mk VII (K) (B16)	1.0; 1.2 Turbo; 1.4; 1.4 Turbo; 1.5 CRDi; 1.6 BiTurbo; 1.6 CDTi; 1.6 Turbo	lug-15	In produzione	8 / 9	AB6039AT + AB6040AT	-	DEXRON HP
VAUXHALL	ASTRA Mk VII (K) (B16)	1.4 Turbo	ago-19	In produzione	CVT	AB6053AT + AB6054AT	-	OPEL 95529854

Marca / Brand:	Modello / Model:	Versioni / Version:	Da anno / From:	Ad anno / To:	Marce / Gears:	Codice AB PARTS		Lubrificante Consigliato
VAUXHALL	ASTRA Mk VII (K) Familiare (B16)	1.0; 1.2 Turbo; 1.4; 1.4 Turbo; 1.5 CRDI; 1.6 Biturbo; 1.6 CDTi; 1.6 Turbo	lug-15	In produzione	8 / 9	AB6039AT + AB6040AT	-	DEXRON HP
VAUXHALL	ASTRA Mk VII (K) Familiare (B16)	1.4 Turbo	ago-19	In produzione	CVT	AB6053AT + AB6054AT	-	OPEL 95529854
VAUXHALL	ASTRAVAN Mk III (F) Furgone/familiare (T92)	1.6 i	ott-91	ago-98	4	AB6004AT	-	DEXRON II
VAUXHALL	ASTRAVAN Mk IV (G) Furgone/familiare (T98)	1.6 i; 2.0 DI	ago-98	ago-06	4	AB6004AT	-	DEXRON II
VAUXHALL	ASTRAVAN Mk V (H) Furgone/familiare (A04)	1.6; 1.9 CDTi	mar-05	In produzione	4	AB6004AT	-	DEXRON II
VAUXHALL	CORSA Mk I (B) (S93)	1.2 i 16V; 1.4 i; 1.4 i 16V	mar-93	set-00	4	AB6004AT	-	DEXRON II
VAUXHALL	CORSA Mk II (C) (X01)	1.0 12V; 1.2 16V; 1.2 Twinport; 1.3 CDTi 16V; 1.4 16V; 1.4 Twinport	set-00	apr-07	4	AB6004AT	-	DEXRON II
VAUXHALL	CORSA Mk III (D) (S07)	1.2; 1.2 i 16V; 1.2 LPG; 1.3 CDTi; 1.4; 1.4 LPG	lug-06	ago-14	4	AB6004AT	-	DEXRON II
VAUXHALL	INSIGNIA Mk II (B) Hatchback (Z18)	2.0 GSI 4X4; 2.0 T	apr-20	In produzione	8 / 9	AB6039AT + AB6040AT	-	DEXRON HP
VAUXHALL	TIGRA Mk I (S93)	1.4 16V	lug-94	dic-00	4	AB6004AT	-	DEXRON II
VAUXHALL	VECTRA (B) Familiare (J96)	1.8 i 16V; 2.0 i 16V; 2.2 i 16V; 2.5 i V6; 2.6 i V6	ago-95	mar-02	4	AB6004AT	-	DEXRON II
VAUXHALL	VECTRA (B) Hatchback (J96)	1.6 i 16V; 1.8 i 16V; 2.0 i 16V; 2.2 i 16V; 2.5 i V6; 2.6 i V6	ago-95	lug-03	4	AB6004AT	-	DEXRON II
VAUXHALL	VECTRA (B) Tre volumi (J96)	1.6 i 16V; 1.8 i 16V; 2.0 i 16V; 2.2 i 16V; 2.5 i V6; 2.6 i V6	ago-95	mar-02	4	AB6004AT	-	DEXRON II
VAUXHALL	ZAFIRA A (T98)	1.8 16V; 2.2 16V	nov-98	ago-05	4	AB6004AT	-	DEXRON II
VOLKSWAGEN	AMAROK (2HA, 2HB, S1B, S6B, S7A, S7B)	2.0 BiTDI; 2.0 BiTDI 4motion; 3.0 TDI 4motion	nov-11	In produzione	8	AB6165AT	-	ZF Lifeguard Fluid 8
VOLKSWAGEN	AMAROK Pianale piatto/Telaio (S1B, S6B, S7B)	2.0 BiTDI; 2.0 BiTDI 4motion; 3.0 TDI 4motion	set-11	mag-22	8	AB6165AT	-	ZF Lifeguard Fluid 8
VOLKSWAGEN	ARTEON (3H7, 3H8)	2.0 TSI 4motion	apr-17	In produzione	7	AB6002AT	-	VW G055540A2
VOLKSWAGEN	ATLAS (CA1, CA2, CA3)	2.0 TSI 4motion; 3.6 FSI 4motion	dic-16	In produzione	7	AB6002AT	-	VW G055540A2
VOLKSWAGEN	BEETLE (5C1, 5C2)	1.2 TSI; 1.2 TSI 16V; 1.4 TSI; 1.6 TDI; 2.0 TDI; 2.0 TFSI; 2.0 TSI; 2.5	apr-11	lug-19	7	AB6024AT	-	Meccatronica: VW G004000 Cambio: VW G052171
VOLKSWAGEN	BEETLE (5C1, 5C2)	1.2 TSI; 1.2 TSI 16V; 1.4 TSI; 2.0 TDI; 2.0 TFSI; 2.0 TSI; 2.5	apr-11	lug-19	6	AB6025AT + AB6026AT	-	VW G052182
VOLKSWAGEN	BEETLE (5C1, 5C2)	1.4 TSI; 2.0 TDI; 2.0 TFSI	apr-11	lug-16	6	AB6025AT + AB6027AT	-	VW G052182
VOLKSWAGEN	BEETLE (5C1, 5C2)	2.0 TDI; 2.5	apr-11	lug-19	6	AB6139AT	-	VW G055025A2
VOLKSWAGEN	BEETLE Cabriolet (5C7, 5C8)	1.2 TSI; 1.2 TSI 16V; 1.4 TSI; 1.6 TDI; 2.0 TDI; 2.0 TFSI; 2.0 TSI; 2.5	dic-11	lug-19	7	AB6024AT	-	Meccatronica: VW G004000 Cambio: VW G052171
VOLKSWAGEN	BEETLE Cabriolet (5C7, 5C8)	1.4 TSI; 2.0 TDI; 2.0 TFSI	dic-11	lug-16	6	AB6025AT + AB6027AT	-	VW G052182
VOLKSWAGEN	BEETLE Cabriolet (5C7, 5C8)	2.0 TDI; 2.0 TFSI; 2.0 TSI; 2.5	dic-11	lug-19	6	AB6025AT + AB6026AT	-	VW G052182
VOLKSWAGEN	BEETLE Cabriolet (5C7, 5C8)	2.0 TSI; 2.5	dic-11	set-18	6	AB6139AT	-	VW G055025A2
VOLKSWAGEN	BORA I (1J2)	1.4 16V; 1.6; 1.6 16V; 1.6 FSI; 1.8; 1.8 4motion; 1.8 T; 1.9 SDI; 1.9 TDI; 1.9 TDI 4motion; 2.0; 2.0 4motion; 2.3 V5; 2.3 V5 4motion; 2.8 V6 4motion	ott-98	dic-13	4	AB6134AT	-	VW G052162A2 + 75W90 G14
VOLKSWAGEN	BORA I (1J2)	1.4 16V; 1.6; 1.6 16V; 1.6 FSI; 1.8; 1.8 4motion; 1.8 T; 1.9 SDI; 1.9 TDI; 1.9 TDI 4motion; 2.0; 2.0 4motion; 2.3 V5; 2.3 V5 4motion; 2.8 V6 4motion	ott-98	dic-13	5	AB6071AT	-	ATF Type K17

Marca / Brand:	Modello / Model:	Versioni / Version:	Da anno / From:	Ad anno / To:	Marce / Gears:	Codice AB PARTS		Lubrificante Consigliato
VOLKSWAGEN	BORA Variant (1J6)	1.4 16V; 1.6; 1.6 16V; 1.6 FSI; 1.8 4motion; 1.8 T; 1.9 TDI; 1.9 TDI 4motion; 2.0; 2.0 4motion; 2.3 V5; 2.3 V5 4motion; 2.8 V6 4motion	mag-99	mag-05	4	AB6134AT	-	VW G052162A2 + 75W90 GL4
VOLKSWAGEN	BORA Variant (1J6)	1.4 16V; 1.6; 1.6 16V; 1.6 FSI; 1.8 4motion; 1.8 T; 1.9 TDI; 1.9 TDI 4motion; 2.0; 2.0 4motion; 2.3 V5; 2.3 V5 4motion; 2.8 V6 4motion	mag-99	mag-05	5	AB6071AT	-	ATF Type K17
VOLKSWAGEN	CADDY ALLTRACK Cassone/Limousine spaziosa (SAA)	1.0 TSI; 1.2 TSI; 1.4 TGI CNG; 1.4 TSI; 1.6 SRE; 1.6 TDI; 2.0 TDI; 2.0 TDI 4motion	mag-15	In produzione	7	AB6024AT	-	Meccatronica: VW G004000 Cambio: VW G052171
VOLKSWAGEN	CADDY ALLTRACK Cassone/Limousine spaziosa (SAA)	1.4 TGI CNG; 2.0 TDI; 2.0 TDI 4motion	mag-15	In produzione	6	AB6025AT + AB6026AT	-	VW G052182
VOLKSWAGEN	CADDY ALLTRACK MPV / Space wagon (SAB)	1.0 TSI; 1.2 TSI; 1.4 TGI CNG; 1.4 TSI; 1.6 SRE; 1.6 TDI; 2.0 TDI; 2.0 TDI 4motion	mag-15	In produzione	7	AB6024AT	-	Meccatronica: VW G004000 Cambio: VW G052171
VOLKSWAGEN	CADDY ALLTRACK MPV / Space wagon (SAB)	1.4 TGI CNG; 2.0 TDI; 2.0 TDI 4motion	mag-15	In produzione	6	AB6025AT + AB6026AT	-	VW G052182
VOLKSWAGEN	CADDY III Cassone/Limousine spaziosa (2KA, 2KH, 2CA, 2CH)	1.2 TSI; 1.6; 1.6 BiFuel; 1.6 TDI; 2.0 EcoFuel; 2.0 TDI; 2.0 TDI 16V; 2.0 TDI 16V 4motion; 2.0 TDI 4motion	apr-04	mag-15	7	AB6024AT	-	Meccatronica: VW G004000 Cambio: VW G052171
VOLKSWAGEN	CADDY III Cassone/Limousine spaziosa (2KA, 2KH, 2CA, 2CH)	1.9 TDI; 1.9 TDI 4motion; 2.0 TDI; 2.0 TDI 16V; 2.0 TDI 16V 4motion; 2.0 TDI 4motion	apr-04	mag-15	6	AB6025AT + AB6027AT	-	VW G052182
VOLKSWAGEN	CADDY III Cassone/Limousine spaziosa (2KA, 2KH, 2CA, 2CH)	1.9 TDI; 2.0 TDI; 2.0 TDI 16V; 2.0 TDI 16V 4motion	apr-04	mag-15	6	AB6025AT + AB6026AT	-	VW G052182
VOLKSWAGEN	CADDY III MPV / Space wagon (2KB, 2KJ, 2CB, 2CJ)	1.2 TSI; 1.6; 1.6 BiFuel; 1.6 TDI; 2.0 EcoFuel; 2.0 TDI; 2.0 TDI 16V; 2.0 TDI 16V 4motion; 2.0 TDI 4motion	apr-04	mag-15	7	AB6024AT	-	Meccatronica: VW G004000 Cambio: VW G052171
VOLKSWAGEN	CADDY III MPV / Space wagon (2KB, 2KJ, 2CB, 2CJ)	1.9 TDI; 1.9 TDI 4motion; 2.0 TDI; 2.0 TDI 16V; 2.0 TDI 16V 4motion; 2.0 TDI 4motion	apr-04	mag-15	6	AB6025AT + AB6027AT	-	VW G052182
VOLKSWAGEN	CADDY III MPV / Space wagon (2KB, 2KJ, 2CB, 2CJ)	1.9 TDI; 2.0 TDI; 2.0 TDI 16V; 2.0 TDI 16V 4motion	apr-04	mag-15	6	AB6025AT + AB6026AT	-	VW G052182
VOLKSWAGEN	CADDY IV Cassone/Limousine spaziosa (SAA, SAH)	1.0 TSI; 1.2 TSI; 1.4 TGI CNG; 1.4 TSI; 1.6; 1.6 TDI; 2.0 TDI; 2.0 TDI 4motion	mag-15	set-20	7	AB6024AT	-	Meccatronica: VW G004000 Cambio: VW G052171
VOLKSWAGEN	CADDY IV Cassone/Limousine spaziosa (SAA, SAH)	1.4 TGI CNG; 2.0 TDI; 2.0 TDI 4motion	mag-15	set-20	6	AB6025AT + AB6026AT	-	VW G052182
VOLKSWAGEN	CADDY IV MPV / Space wagon (SAB, SAJ)	1.0 TSI; 1.2 TSI; 1.4 TGI CNG; 1.4 TSI; 1.6; 1.6 TDI; 2.0 TDI; 2.0 TDI 4motion	mag-15	set-20	7	AB6024AT	-	Meccatronica: VW G004000 Cambio: VW G052171
VOLKSWAGEN	CADDY IV MPV / Space wagon (SAB, SAJ)	1.4 TGI CNG; 2.0 TDI; 2.0 TDI 4motion	mag-15	set-20	6	AB6025AT + AB6026AT	-	VW G052182
VOLKSWAGEN	CC B7 (358)	1.4 TSI; 1.4 TSI MultiFuel; 1.8 TSI; 2.0 TDI; 2.0 TDI 4motion; 2.0 TSI; 3.6 FSI 4motion	nov-11	dic-16	7	AB6024AT	-	Meccatronica: VW G004000 Cambio: VW G052171
VOLKSWAGEN	CC B7 (358)	1.8 TSI; 2.0 TDI; 2.0 TSI	nov-11	dic-16	6	AB6025AT + AB6027AT	-	VW G052182
VOLKSWAGEN	CC B7 (358)	2.0 TDI; 2.0 TDI 4motion; 2.0 TSI; 3.6 FSI 4motion	nov-11	dic-16	6	AB6025AT + AB6026AT	-	VW G052182
VOLKSWAGEN	CORRADO (53I)	1.8 16V; 1.8 G60; 2.0 i; 2.0 i 16V; 2.9 VR6	set-88	dic-95	4	AB6132AT *	AB6133AT *	VW G052162A2 + 75W90 GL4
VOLKSWAGEN	CRAFTER Autobus (SYL, SYJ)	2.0 TDI; 2.0 TDI 4motion	set-16	In produzione	8	AB6164AT	-	ZF Lifeguard Fluid 8

Marca / Brand:	Modello / Model:	Versioni / Version:	Da anno / From:	Ad anno / To:	Marce / Gears:	Codice AB PARTS		Lubrificante Consigliato
VOLKSWAGEN	CRAFTER Autobus (SYI, SYJ)	2.0 TDI; 2.0 TDI 4motion	set-16	In produzione	8	AB6140AT	-	VW G055540A2
VOLKSWAGEN	CRAFTER Furgone (SY_, SX_)	2.0 TDI; 2.0 TDI 4motion; 2.0 TDI RWD	set-16	In produzione	8	AB6164AT	-	ZF Lifeguard Fluid 8
VOLKSWAGEN	CRAFTER Furgone (SY_, SX_)	2.0 TDI; 2.0 TDI 4motion; 2.0 TDI RWD; e-Crafter	set-16	In produzione	8	AB6140AT	-	VW G055540A2
VOLKSWAGEN	CRAFTER Pianale piatto/Telaio (SZ_)	2.0 TDI; 2.0 TDI 4motion; 2.0 TDI RWD	nov-16	In produzione	8	AB6164AT	-	ZF Lifeguard Fluid 8
VOLKSWAGEN	CRAFTER Pianale piatto/Telaio (SZ_)	2.0 TDI; 2.0 TDI 4motion; 2.0 TDI RWD	nov-16	In produzione	8	AB6140AT	-	VW G055540A2
VOLKSWAGEN	EOS (1F7, 1F8)	1.4 TSI; 2.0 TDI; 2.0 TDI 16V; 2.0 TFSI; 2.0 TSI; 3.2 V6; 3.6 V6	mar-06	ago-15	6	AB6025AT + AB6027AT	-	VW G052182
VOLKSWAGEN	EOS (1F7, 1F8)	2.0 TDI; 2.0 TDI 16V; 2.0 TFSI; 2.0 TSI; 3.2 V6; 3.6 V6	mar-06	ago-15	6	AB6025AT + AB6026AT	-	VW G052182
VOLKSWAGEN	GOLF ALLTRACK VII Variant (BA5, BV5)	1.6 TDI 4motion; 2.0 TDI 4motion	dic-14	ago-20	7	AB6024AT	-	Meccatronica: VW G004000 Cambio: VW G052171
VOLKSWAGEN	GOLF ALLTRACK VII Variant (BA5, BV5)	1.8 TSI 4motion; 2.0 TDI 4motion	dic-14	ago-20	6	AB6025AT + AB6026AT	-	VW G052182
VOLKSWAGEN	GOLF ALLTRACK VII Variant (BA5, BV5)	1.8 TSI 4motion; 2.0 TDI 4motion	dic-14	ago-20	6	AB6138AT *	AB6139AT *	VW G055025A2
VOLKSWAGEN	GOLF Furgone/hatchback (1K1)	TDI	nov-03	feb-06	7	AB6024AT	-	Meccatronica: VW G004000 Cambio: VW G052171
VOLKSWAGEN	GOLF Furgone/hatchback (1K1)	TDI	nov-03	feb-06	6	AB6137AT	-	VW G055025A2
VOLKSWAGEN	GOLF III (1H1)	1.4; 1.6; 1.8; 1.8 Syncro; 1.9 D; 1.9 SDI; 1.9 TD, GTD; 1.9 TDI; 1.9 TDI Syncro; 2.0; 2.0 GL; 2.0 GTI 16V; 2.0 Syncro; 2.8 VR6; 2.9 VR6 Syncro; Citystromer	ott-91	set-97	4	AB6134AT	-	VW G052162A2 + 75W90 Gl4
VOLKSWAGEN	GOLF III (1H1)	1.6; 1.8; 1.9 SDI; 1.9 TD, GTD; 1.9 TDI; 2.0; 2.8 VR6	nov-91	ago-97	4	AB6132AT *	AB6133AT *	VW G052162A2 + 75W90 Gl4
VOLKSWAGEN	GOLF III Cabriolet (1E7)	2.0	lug-93	mag-98	4	AB6132AT *	AB6133AT *	VW G052162A2 + 75W90 Gl4
VOLKSWAGEN	GOLF III Van (1H1)	1.4; 1.6; 1.8; 1.9 D; 1.9 SDI; 1.9 TDI; 2.0; 2.0 GTI	ago-91	dic-97	4	AB6134AT	-	VW G052162A2 + 75W90 Gl4
VOLKSWAGEN	GOLF III Variant (1H5)	1.4; 1.6; 1.8; 1.8 Syncro; 1.9 D; 1.9 SDI; 1.9 TD; 1.9 TDI; 1.9 TDI Syncro; 2.0; 2.0 Syncro; 2.9 VR6 Syncro	lug-93	apr-99	4	AB6134AT	-	VW G052162A2 + 75W90 Gl4
VOLKSWAGEN	GOLF III Variant (1H5)	1.4; 1.6; 1.8; 1.9 TDI; 2.0	lug-93	apr-99	4	AB6132AT *	AB6133AT *	VW G052162A2 + 75W90 Gl4
VOLKSWAGEN	GOLF III Variant (1H5)	2.0	ago-95	apr-96	7	AB6024AT	-	Meccatronica: VW G004000 Cambio: VW G052171
VOLKSWAGEN	GOLF IV (1J1)	1.4 16V; 1.6; 1.6 16V; 1.6 FSI; 1.8; 1.8 4motion; 1.8 T; 1.8 T GTI; 1.9 SDI; 1.9 TDI; 1.9 TDI 4motion; 2.0; 2.0 4motion; 2.0 BiFuel; 2.3 V5; 2.3 V5 4motion; 2.8 VR6 4motion; 3.2 R32 4motion	ago-97	giu-05	4	AB6134AT	-	VW G052162A2 + 75W90 Gl4
VOLKSWAGEN	GOLF IV (1J1)	1.4 16V; 1.6; 1.6 16V; 1.6 FSI; 1.8; 1.8 4motion; 1.8 T; 1.8 T GTI; 1.9 SDI; 1.9 TDI; 1.9 TDI 4motion; 2.0; 2.0 4motion; 2.3 V5; 2.3 V5 4motion; 2.8 VR6 4motion; 3.2 R32 4motion	ago-97	giu-05	5	AB6071AT	-	ATF Type K17
VOLKSWAGEN	GOLF IV (1J1)	1.9 TDI; 2.3 V5; 3.2 R32 4motion	set-00	giu-05	6	AB6025AT + AB6026AT	-	VW G052182
VOLKSWAGEN	GOLF IV (1J1)	3.2 R32 4motion	set-02	giu-05	6	AB6025AT + AB6027AT	-	VW G052182
VOLKSWAGEN	GOLF IV Cabriolet (1E7)	1.8	giu-98	giu-02	4	AB6132AT *	AB6133AT *	VW G052162A2 + 75W90 Gl4
VOLKSWAGEN	GOLF IV Van (1J1)	1.9 SDI; 1.9 TDI; 1.9 TDI 4motion	ott-97	mag-04	4	AB6134AT	-	VW G052162A2 + 75W90 Gl4

Marca / Brand:	Modello / Model:	Versioni / Version:	Da anno / From:	Ad anno / To:	Marce / Gears:	Codice AB PARTS		Lubrificante Consigliato
VOLKSWAGEN	GOLF IV Variant (1J5)	1.4 16V; 1.6; 1.6 16V; 1.6 FSI; 1.8 4motion; 1.8 T; 1.9 SDI; 1.9 TDI; 1.9 TDI 4motion; 2.0; 2.0 4motion; 2.0 Bi-Fuel; 2.3 V5; 2.3 V5 4motion; 2.8 V6 4motion	mag-99	giu-06	4	AB6134AT	-	VW G052162A2 + 75W90 GI4
VOLKSWAGEN	GOLF IV Variant (1J5)	1.4 16V; 1.6; 1.6 16V; 1.6 FSI; 1.8 4motion; 1.8 T; 1.9 SDI; 1.9 TDI; 1.9 TDI 4motion; 2.0; 2.0 4motion; 2.0 Bi-Fuel; 2.3 V5; 2.3 V5 4motion; 2.8 V6 4motion	mag-99	giu-06	5	AB6071AT	-	ATF Type K17
VOLKSWAGEN	GOLF IV Variant (1J5)	1.9 TDI; 2.3 V5	ott-00	giu-06	6	AB6025AT + AB6026AT	-	VW G052182
VOLKSWAGEN	GOLF PLUS V (5M1, 521)	1.2 TSI; 1.4 16V; 1.4 FSI; 1.4 TSI; 1.6; 1.6 BiFuel; 1.6 FSI; 1.6 MultiFuel; 1.6 TDI; 1.9 TDI; 2.0 FSI; 2.0 TDI; 2.0 TDI 16V	dic-04	dic-13	7	AB6024AT	-	Meccatronica: VW G004000 Cambio: VW G052171
VOLKSWAGEN	GOLF PLUS V (5M1, 521)	1.4 16V; 1.4 FSI; 1.4 TSI; 1.6; 1.6 FSI; 1.9 TDI; 2.0 FSI; 2.0 TDI; 2.0 TDI 16V	dic-04	dic-13	6	AB6136AT	-	VW G055025A2
VOLKSWAGEN	GOLF PLUS V (5M1, 521)	1.4 TSI; 1.6; 1.6 BiFuel; 1.6 FSI; 1.6 MultiFuel; 1.9 TDI; 2.0 FSI; 2.0 TDI; 2.0 TDI 16V	dic-04	dic-13	6	AB6137AT	-	VW G055025A2
VOLKSWAGEN	GOLF PLUS V (5M1, 521)	1.4 TSI; 1.6; 1.6 FSI; 1.9 TDI; 2.0 FSI; 2.0 TDI; 2.0 TDI 16V	dic-04	dic-13	6	AB6025AT + AB6026AT	-	VW G052182
VOLKSWAGEN	GOLF PLUS V (5M1, 521)	1.4 TSI; 1.9 TDI; 2.0 TDI; 2.0 TDI 16V	gen-05	dic-13	6	AB6025AT + AB6027AT	-	VW G052182
VOLKSWAGEN	GOLF PLUS Van (521)	1.2 TSI; 1.4 TSI; 1.6 TDI	gen-09	ago-14	7	AB6024AT	-	Meccatronica: VW G004000 Cambio: VW G052171
VOLKSWAGEN	GOLF PLUS Van (521)	2.0 TDI	nov-09	ago-14	6	AB6025AT + AB6026AT	-	VW G052182
VOLKSWAGEN	GOLF SPORTSVAN VII (AM1, AN1)	1.0 TSI; 1.2 TSI; 1.4 TSI; 1.4 TSI MultiFuel; 1.5 TSI; 1.6; 1.6 TDI; 2.0 TDI	feb-14	ago-20	7	AB6024AT	-	Meccatronica: VW G004000 Cambio: VW G052171
VOLKSWAGEN	GOLF SPORTSVAN VII (AM1, AN1)	2.0 TDI	feb-14	ago-20	6	AB6025AT + AB6026AT	-	VW G052182
VOLKSWAGEN	GOLF V (1K1)	1.4 16V; 1.4 FSI; 1.4 TSI; 1.6; 1.6 FSI; 1.6 MultiFuel; 1.9 TDI; 1.9 TDI 4motion; 2.0; 2.0 FSI; 2.0 FSI 4motion; 2.0 GTI; 2.0 SDI; 2.0 TDI; 2.0 TDI 16V; 2.0 TDI 16V 4motion; 2.0 TDI 4motion; 3.2 R32 4motion	ott-03	feb-09	7	AB6024AT	-	Meccatronica: VW G004000 Cambio: VW G052171
VOLKSWAGEN	GOLF V (1K1)	1.4 16V; 1.4 FSI; 1.4 TSI; 1.6; 1.6 FSI; 1.9 TDI; 1.9 TDI 4motion; 2.0 FSI; 2.0 FSI 4motion; 2.0 GTI; 2.0 SDI; 2.0 TDI; 2.0 TDI 16V; 2.0 TDI 16V 4motion; 2.0 TDI 4motion; 3.2 R32 4motion	ott-03	feb-09	6	AB6136AT	-	VW G055025A2
VOLKSWAGEN	GOLF V (1K1)	1.4 TSI; 1.6; 1.6 FSI; 1.6 MultiFuel; 1.9 TDI; 1.9 TDI 4motion; 2.0 FSI; 2.0 FSI 4motion; 2.0 GTI; 2.0 TDI; 2.0 TDI 16V; 2.0 TDI 16V 4motion; 2.0 TDI 4motion	ott-03	feb-09	6	AB6137AT	-	VW G055025A2
VOLKSWAGEN	GOLF V (1K1)	1.4 TSI; 1.6; 1.6 FSI; 1.9 TDI; 2.0 FSI; 2.0 GTI; 2.0 TDI; 2.0 TDI 16V; 3.2 R32 4motion	ott-03	feb-09	6	AB6025AT + AB6026AT	-	VW G052182
VOLKSWAGEN	GOLF V (1K1)	1.4 TSI; 1.9 TDI; 1.9 TDI 4motion; 2.0 GTI; 2.0 TDI; 2.0 TDI 16V; 2.0 TDI 16V 4motion; 2.0 TDI 4motion; 3.2 R32 4motion	ott-03	feb-09	6	AB6025AT + AB6027AT	-	VW G052182
VOLKSWAGEN	GOLF V Variant (1K5)	1.4 TSI; 1.6; 1.6 MultiFuel; 1.9 TDI; 1.9 TDI 4motion; 2.0 TDI; 2.0 TDI 16V; 2.0 TFSI	giu-07	lug-09	6	AB6137AT	-	VW G055025A2
VOLKSWAGEN	GOLF V Variant (1K5)	1.4 TSI; 1.6; 1.9 TDI; 1.9 TDI 4motion; 2.0 TDI; 2.0 TDI 16V; 2.0 TFSI	giu-07	lug-09	6	AB6136AT	-	VW G055025A2
VOLKSWAGEN	GOLF V Variant (1K5)	1.4 TSI; 1.6; 1.9 TDI; 1.9 TDI 4motion; 2.0 TDI; 2.0 TDI 16V; 2.0 TFSI	giu-07	lug-09	6	AB6025AT + AB6026AT	-	VW G052182
VOLKSWAGEN	GOLF V Variant (1K5)	1.4 TSI; 1.9 TDI; 1.9 TDI 4motion; 2.0 TDI; 2.0 TDI 16V; 2.0 TFSI	giu-07	lug-09	6	AB6025AT + AB6027AT	-	VW G052182

Marca / Brand:	Modello / Model:	Versioni / Version:	Da anno / From:	Ad anno / To:	Marce / Gears:	Codice AB PARTS		Lubrificante Consigliato
VOLKSWAGEN	GOLF V Variant (1K5)	1.4; 1.4 TSi; 1.6; 1.6 MultiFuel; 1.9 TDI; 1.9 TDI 4motion; 2.0 TDI; 2.0 TDI 16V	giu-07	lug-09	7	AB6024AT	-	Meccatronica: VW G004000 Cambio: VW G052171
VOLKSWAGEN	GOLF Van III Variant (1H5)	1.4; 1.8; 1.9; 1.9 SDI; 1.9 TDI	mag-93	dic-99	4	AB6134AT	-	VW G052162A2 + 75W90 Gl4
VOLKSWAGEN	GOLF VAN IV Variant (1J5)	1.4; 1.6; 1.9 SDI; 1.9 TDI	mag-99	giu-06	4	AB6134AT	-	VW G052162A2 + 75W90 Gl4
VOLKSWAGEN	GOLF VAN IV Variant (1J5)	1.9 TDI	apr-01	mag-06	6	AB6025AT + AB6026AT	-	VW G052182
VOLKSWAGEN	GOLF VAN VI Variant (AJ5)	1.2 TSi; 1.4 TSi; 1.6 TDi; 1.6 TDi BlueMotion; 2.0 TDi	lug-09	mag-14	7	AB6024AT	-	Meccatronica: VW G004000 Cambio: VW G052171
VOLKSWAGEN	GOLF VAN VI Variant (AJ5)	2.0 TDi	lug-09	mag-14	6	AB6025AT + AB6026AT	-	VW G052182
VOLKSWAGEN	GOLF VAN VI Variant (AJ5)	2.0 TDi	lug-09	mag-14	6	AB6137AT	-	VW G055025A2
VOLKSWAGEN	GOLF VAN VII Variant (BA5)	1.6 TDi BlueMotion; 1.6 TDi BlueMotion 4motion; 2.0 TDi BlueMotion; 2.0 TDi BlueMotion 4motion	apr-13	mar-17	7	AB6024AT	-	Meccatronica: VW G004000 Cambio: VW G052171
VOLKSWAGEN	GOLF VAN VII Variant (BA5)	2.0 TDi BlueMotion	apr-13	mar-17	6	AB6025AT + AB6026AT	-	VW G052182
VOLKSWAGEN	GOLF VI (5K1)	1.2 TSi; 1.4; 1.4 TSi; 1.6; 1.6 BiFuel; 1.6 MultiFuel; 1.6 TDi; 1.8 TSi; 2.0 GTi; 2.0 R 4motion; 2.0 TDi; 2.0 TDi 4motion	ott-08	nov-13	7	AB6024AT	-	Meccatronica: VW G004000 Cambio: VW G052171
VOLKSWAGEN	GOLF VI (5K1)	1.4 TSi; 1.8 TSi; 2.0 GTi; 2.0 R 4motion; 2.0 TDi; 2.0 TDi 4motion	ott-08	nov-13	6	AB6025AT + AB6027AT	-	VW G052182
VOLKSWAGEN	GOLF VI (5K1)	1.6; 1.6 BiFuel; 1.6 MultiFuel; 2.0 GTi; 2.0 TDi; 2.0 TDi 4motion; 2.5	ott-08	nov-13	6	AB6137AT	-	VW G055025A2
VOLKSWAGEN	GOLF VI (5K1)	2.0 GTi; 2.0 R 4motion; 2.0 TDi; 2.5	ott-08	nov-13	6	AB6025AT + AB6026AT	-	VW G052182
VOLKSWAGEN	GOLF VI Cabriolet (517)	1.2 TSi; 1.2 TSi 16V; 1.4 TSi; 1.6 TDi; 2.0 GTi; 2.0 R; 2.0 TDi	mar-11	mag-16	7	AB6024AT	-	Meccatronica: VW G004000 Cambio: VW G052171
VOLKSWAGEN	GOLF VI Cabriolet (517)	1.4 TSi; 2.0 GTi; 2.0 TDi	mar-11	mag-16	6	AB6025AT + AB6027AT	-	VW G052182
VOLKSWAGEN	GOLF VI Cabriolet (517)	2.0 GTi; 2.0 R; 2.0 TDi; 2.0 TSi	nov-11	mag-16	6	AB6025AT + AB6026AT	-	VW G052182
VOLKSWAGEN	GOLF VI Cabriolet (517)	2.0 GTi; 2.0 TDi	nov-11	mag-16	6	AB6137AT	-	VW G055025A2
VOLKSWAGEN	GOLF VI Van (5K1_)	1.2 TSi BlueMotion; 1.4 TSi; 1.6 TDi BlueMotion; 2.0 TDi; TSi	ott-08	nov-12	7	AB6024AT	-	Meccatronica: VW G004000 Cambio: VW G052171
VOLKSWAGEN	GOLF VI Van (5K1_)	2.0 TDi	set-09	nov-12	6	AB6025AT + AB6026AT	-	VW G052182
VOLKSWAGEN	GOLF VI Van (5K1_)	2.0 TDi	set-09	nov-12	6	AB6137AT	-	VW G055025A2
VOLKSWAGEN	GOLF VI Variant (AJ5)	1.2 TSi; 1.4; 1.4 TSi; 1.6; 1.6 BiFuel; 1.6 MultiFuel; 1.6 TDi; 1.6 TDi 4motion; 2.0 TDi; 2.0 TFSI	lug-09	lug-13	7	AB6024AT	-	Meccatronica: VW G004000 Cambio: VW G052171
VOLKSWAGEN	GOLF VI Variant (AJ5)	1.4 TSi; 2.0 TDi	lug-09	lug-13	6	AB6025AT + AB6027AT	-	VW G052182

Marca / Brand:	Modello / Model:	Versioni / Version:	Da anno / From:	Ad anno / To:	Marce / Gears:	Codice AB PARTS		Lubrificante Consigliato
VOLKSWAGEN	GOLF VI Variant (AJ5)	1.4 TSI; 2.0 TDI; 2.0 TFSI	lug-09	lug-13	6	AB6025AT + AB6026AT	-	VW G052182
VOLKSWAGEN	GOLF VI Variant (AJ5)	1.6; 1.6 BiFuel; 1.6 MultiFuel; 2.0 TDI	lug-09	lug-13	6	AB6137AT	-	VW G055025A2
VOLKSWAGEN	GOLF VII (5G1, BQ1, BE1, BE2)	1.0 TSI; 1.2 TSI; 1.4 GTE Hybrid; 1.4 TGI CNG; 1.4 TSI; 1.4 TSI MultiFuel; 1.5 TGI; 1.5 TSI; 1.6; 1.6 TDI; 1.6 TDI 4motion; 2.0 GTD; 2.0 GTI; 2.0 GTI Clubsport; 2.0 GTI Clubsport S; 2.0 R 4motion; 2.0 TDI; 2.0 TDI 4motion	ago-12	mar-21	7	AB6024AT	-	Meccatronica: VW G004000 Cambio: VW G052171
VOLKSWAGEN	GOLF VII (5G1, BQ1, BE1, BE2)	1.0 TSI; 1.4 GTE Hybrid; 1.4 TGI CNG; 1.4 TSI; 1.5 TGI; 1.5 TSI; 1.6; 1.6 TDI; 2.0 GTD; 2.0 GTI; 2.0 GTI TCR; 2.0 R 4motion; 2.0 TDI; 2.0 TDI 4motion	ago-12	mar-21	6	AB6138AT *	AB6139AT *	VW G055025A2
VOLKSWAGEN	GOLF VII (5G1, BQ1, BE1, BE2)	1.4 GTE Hybrid	mag-14	ago-20	7	AB6029AT + AB6031AT *	- AB6032AT *	VW G055529A2
VOLKSWAGEN	GOLF VII (5G1, BQ1, BE1, BE2)	1.4 GTE Hybrid	mag-14	ago-20	7	AB6029AT + AB6031AT *	- AB6032AT *	VW G055529A2
VOLKSWAGEN	GOLF VII (5G1, BQ1, BE1, BE2)	1.4 TGI CNG; 1.6; 2.0 GTD; 2.0 GTI; 2.0 GTI Clubsport; 2.0 GTI TCR; 2.0 R 360S 4motion; 2.0 R 4motion; 2.0 TDI; 2.0 TDI 4motion	ago-12	ago-20	6	AB6025AT + AB6026AT	-	VW G052182
VOLKSWAGEN	GOLF VII (5G1, BQ1, BE1, BE2)	1.4 TSI; 2.0 TDI	ago-12	ago-20	6	AB6025AT + AB6027AT	-	VW G052182
VOLKSWAGEN	GOLF VII (5G1, BQ1, BE1, BE2)	1.6	mag-14	lug-17	6	AB6139AT	-	VW G055025A2
VOLKSWAGEN	GOLF VII (5G1, BQ1, BE1, BE2)	2.0 GTI	mar-17	ago-20	7	AB6029AT + AB6031AT *	- AB6032AT *	VW G055529A2
VOLKSWAGEN	GOLF VII Van (5G1)	1.2 TSi BlueMotion; 1.6 TDi BlueMotion; 2.0 GTI; 2.0 TDi BlueMotion; 2.0 TDi BlueMotion 4motion	ago-12	mar-17	7	AB6024AT	-	Meccatronica: VW G004000 Cambio: VW G052171
VOLKSWAGEN	GOLF VII Van (5G1)	2.0 GTI; 2.0 TDi BlueMotion	apr-13	mar-17	6	AB6025AT + AB6026AT	-	VW G052182
VOLKSWAGEN	GOLF VII Variant (BA5, BV5)	1.0 TSI; 1.2 TSI; 1.4 TGI CNG; 1.4 TSI; 1.4 TSI MultiFuel; 1.5 TGI; 1.5 TSI; 1.6; 1.6 TDI; 1.6 TDI 4motion; 2.0 GTD; 2.0 R 4motion; 2.0 TDI; 2.0 TDI 4motion	apr-13	mar-21	7	AB6024AT	-	Meccatronica: VW G004000 Cambio: VW G052171
VOLKSWAGEN	GOLF VII Variant (BA5, BV5)	1.0 TSI; 1.2 TSI; 1.4 TGI CNG; 1.4 TSI; 1.5 TGI; 1.5 TSI; 1.6 TDI; 2.0 GTD; 2.0 R 4motion; 2.0 TDI	apr-13	mar-21	6	AB6138AT *	AB6139AT *	VW G055025A2
VOLKSWAGEN	GOLF VII Variant (BA5, BV5)	1.4 TGI CNG; 2.0 GTD; 2.0 R 360S 4motion; 2.0 R 4motion; 2.0 TDI	apr-13	ago-20	6	AB6025AT + AB6026AT	-	VW G052182
VOLKSWAGEN	GOLF VII Variant (BA5, BV5)	1.4 TSI; 2.0 TDI	apr-13	ago-20	6	AB6025AT + AB6027AT	-	VW G052182
VOLKSWAGEN	GOLF VII Variant (BA5, BV5)	1.6	mag-14	lug-17	6	AB6139AT	-	VW G055025A2
VOLKSWAGEN	GRAND CALIFORNIA Camper (SCB, SCC)	2.0 TDI; 2.0 TDI 4motion	apr-19	In produzione	8	AB6140AT	-	VW G055540A2
VOLKSWAGEN	JETTA III (1K2)	1.4 TSI; 1.6; 1.6 FSI; 1.6 MultiFuel; 1.9 TDI; 2.0 FSI; 2.0 TDI; 2.0 TDI 16V; 2.0 TFSI; 2.5	set-04	ott-10	6	AB6137AT	-	VW G055025A2
VOLKSWAGEN	JETTA III (1K2)	1.4 TSI; 1.6; 1.6 FSI; 1.9 TDI; 2.0 FSI; 2.0 TDI; 2.0 TDI 16V; 2.0 TFSI	set-04	ott-10	6	AB6136AT	-	VW G055025A2
VOLKSWAGEN	JETTA III (1K2)	1.4 TSI; 1.6; 1.6 MultiFuel; 1.6 TDI; 1.9 TDI	set-04	ott-10	7	AB6024AT	-	Meccatronica: VW G004000 Cambio: VW G052171
VOLKSWAGEN	JETTA III (1K2)	1.4 TSI; 1.6; 1.6 TDI; 1.9 TDI; 2.0 FSI; 2.0 TDI; 2.0 TDI 16V; 2.0 TFSI; 2.5	set-04	ott-10	6	AB6025AT + AB6026AT	-	VW G052182

Marca / Brand:	Modello / Model:	Versioni / Version:	Da anno / From:	Ad anno / To:	Marce / Gears:	Codice AB PARTS		Lubrificante Consigliato
VOLKSWAGEN	JETTA III (1K2)	1.4 TSI; 1.9 TDI; 2.0 TDI; 2.0 TDI 16V; 2.0 TFSI	ago-05	ott-10	6	AB6025AT + AB6027AT	-	VW G052182
VOLKSWAGEN	JETTA IV (162, 163, AV3, AV2)	1.2 TSI; 1.2 TSI 16V; 1.4 TSI; 1.4 TSI Hybrid; 1.6; 1.6 TDI; 2.0 TSI	apr-10	apr-18	7	AB6024AT	-	Meccatronica: VW G004000 Cambio: VW G052171
VOLKSWAGEN	JETTA IV (162, 163, AV3, AV2)	1.4 TSI; 1.6; 1.8 TSI; 2.0; 2.0 TDI; 2.0 TFSI; 2.0 TSI; 2.5	apr-10	apr-18	6	AB6025AT + AB6026AT	-	VW G052182
VOLKSWAGEN	JETTA IV (162, 163, AV3, AV2)	1.4 TSI; 1.6; 1.8 TSI; 2.0; 2.5	apr-10	apr-18	6	AB6139AT	-	VW G055025A2
VOLKSWAGEN	JETTA IV (162, 163, AV3, AV2)	1.6	set-15	apr-18	6	AB6138AT *	AB6139AT *	VW G055025A2
VOLKSWAGEN	JETTA IV (162, 163, AV3, AV2)	2.0 TDI; 2.0 TFSI	dic-10	dic-17	6	AB6025AT + AB6027AT	-	VW G052182
VOLKSWAGEN	JETTA VII Tre volumi (BU3, BU4)	1.4 TSI	dic-17	In produzione	7	AB6024AT	-	Meccatronica: VW G004000 Cambio: VW G052171
VOLKSWAGEN	JETTA VII Tre volumi (BU3, BU4)	1.4 TSI	dic-17	In produzione	6	AB6138AT *	AB6139AT *	VW G055025A2
VOLKSWAGEN	LUPO I (6X1, 6E1)	1.4 16V	set-98	lug-05	4	AB6069AT	-	AISIN ATF-0T4
VOLKSWAGEN	MULTIVAN T5 (7HM, 7HN, 7HF, 7EF, 7EM, 7EN)	2.0 BitDI; 2.0 BitDI 4motion; 2.0 TDI; 2.0 TDI 4motion	set-09	ago-15	7	AB6029AT + AB6031AT *	AB6032AT *	VW G055529A2
VOLKSWAGEN	MULTIVAN T5 (7HM, 7HN, 7HF, 7EF, 7EM, 7EN)	2.0 BitDI; 2.0 BitDI 4motion; 2.0 TDI; 2.0 TDI 4motion	set-09	ago-15	7	AB6029AT + AB6031AT *	AB6032AT *	VW G055529A2
VOLKSWAGEN	MULTIVAN T5 (7HM, 7HN, 7HF, 7EF, 7EM, 7EN)	2.5 TDI; 2.5 TDI 4motion; VR6 3.2; VR6 3.2 4motion	apr-03	dic-09	6	AB6007AT	-	VW G055025A2
VOLKSWAGEN	MULTIVAN T6 (SGF, SGM, SGN, SHM, SHN)	2.0 TDI; 2.0 TDI 4motion	apr-15	dic-19	7	AB6029AT + AB6031AT *	AB6032AT *	VW G055529A2
VOLKSWAGEN	MULTIVAN T6 (SGF, SGM, SGN, SHM, SHN)	2.0 TDI; 2.0 TDI 4motion	apr-15	dic-19	7	AB6029AT + AB6031AT *	AB6032AT *	VW G055529A2
VOLKSWAGEN	NEW BEETLE (9C1, 1C1)	1.4; 1.6; 1.8 T; 1.9 TDI; 2.0; 2.3 V5; 2.5; 3.2 RSI 4motion	gen-98	set-10	4	AB6134AT	-	VW G052162A2 + 75W90 GL4
VOLKSWAGEN	NEW BEETLE (9C1, 1C1)	1.4; 1.6; 1.8 T; 1.9 TDI; 2.0; 2.3 V5; 2.5; 3.2 RSI 4motion	gen-98	set-10	6	AB6136AT	-	VW G055025A2
VOLKSWAGEN	NEW BEETLE (9C1, 1C1)	1.4; 1.6; 1.8 T; 2.0; 2.3 V5; 2.5; 3.2 RSI 4motion	gen-98	set-10	6	AB6137AT	-	VW G055025A2
VOLKSWAGEN	NEW BEETLE (9C1, 1C1)	1.9 TDI	feb-01	set-10	6	AB6025AT + AB6026AT	-	VW G052182
VOLKSWAGEN	NEW BEETLE (9C1, 1C1)	1.9 TDI	feb-01	set-10	6	AB6025AT + AB6027AT	-	VW G052182
VOLKSWAGEN	NEW BEETLE Cabriolet (1Y7)	1.4; 1.6; 1.8 T; 1.9 TDI; 2.0; 2.5	set-02	ott-10	4	AB6134AT	-	VW G052162A2 + 75W90 GL4
VOLKSWAGEN	NEW BEETLE Cabriolet (1Y7)	1.4; 1.6; 1.8 T; 1.9 TDI; 2.0; 2.5	set-02	ott-10	6	AB6136AT	-	VW G055025A2
VOLKSWAGEN	NEW BEETLE Cabriolet (1Y7)	1.4; 1.6; 1.8 T; 2.0; 2.5	set-02	ott-10	6	AB6137AT	-	VW G055025A2
VOLKSWAGEN	NEW BEETLE Cabriolet (1Y7)	1.9 TDI	giu-03	lug-05	6	AB6025AT + AB6027AT	-	VW G052182
VOLKSWAGEN	PASSAT ALLTRACK B7 (365)	1.8 TSI; 2.0 TDI; 2.0 TDI 4motion; 2.0 TSI 4motion	gen-12	dic-14	7	AB6024AT	-	Meccatronica: VW G004000 Cambio: VW G052171
VOLKSWAGEN	PASSAT ALLTRACK B7 (365)	1.8 TSI; 2.0 TDI; 2.0 TDI 4motion; 2.0 TSI 4motion	gen-12	dic-14	6	AB6025AT + AB6027AT	-	VW G052182

Marca / Brand:	Modello / Model:	Versioni / Version:	Da anno / From :	Ad anno / To:	Marce / Gears:	Codice AB PARTS		Lubrificante Consigliato
VOLKSWAGEN	PASSAT ALLTRACK B7 (365)	2.0 TDI 4motion; 2.0 TSI 4motion	gen-12	dic-14	6	AB6025AT + AB6026AT	-	VW G052182
VOLKSWAGEN	PASSAT ALLTRACK B7 (365)	2.0 TSI 4motion	gen-12	dic-14	6	AB6137AT	-	VW G055025A2
VOLKSWAGEN	PASSAT ALLTRACK B8 Variant (3G5, CB5)	1.4 TSI 4motion; 2.0 TDI 4motion; 2.0 TSI 4motion	mag-15	In produzione	7	AB6024AT	-	Meccatronica: VW G004000 Cambio: VW G052171
VOLKSWAGEN	PASSAT B3/B4 (315, 3A5)	1.8; 1.9 TD; 2.0; 2.0 Syncro	set-89	dic-96	4	AB6134AT	-	VW G052162A2 + 75W90 Gl4
VOLKSWAGEN	PASSAT B3/B4 (3A2, 35I)	1.6; 1.6 TD; 1.8; 1.8 16V; 1.8 G60 Syncro; 1.9 D; 1.9 TD; 1.9 TDI; 2.0; 2.0 16V; 2.0 Syncro; 2.8 VR6	feb-88	ago-96	4	AB6134AT	-	VW G052162A2 + 75W90 Gl4
VOLKSWAGEN	PASSAT B3/B4 (3A2, 35I)	1.6; 1.6 TD; 1.8; 1.8 16V; 1.9 D; 1.9 TD; 2.0; 2.0 16V; 2.8 VR6	feb-88	ago-96	4	AB6132AT *	AB6133AT *	VW G052162A2 + 75W90 Gl4
VOLKSWAGEN	PASSAT B3/B4 Variant (3A5, 35I)	1.6; 1.6 TD; 1.8; 1.8 16V; 1.8 G60 Syncro; 1.9 D; 1.9 TD; 1.9 TDI; 2.0; 2.0 16V; 2.0 Syncro; 2.8 VR6; 2.9 VR6 Syncro	feb-88	mag-97	4	AB6134AT	-	VW G052162A2 + 75W90 Gl4
VOLKSWAGEN	PASSAT B3/B4 Variant (3A5, 35I)	1.6; 1.6 TD; 1.8; 1.8 16V; 1.9 D; 1.9 TD; 2.0; 2.0 16V; 2.8 VR6	feb-88	mag-97	4	AB6132AT *	AB6133AT *	VW G052162A2 + 75W90 Gl4
VOLKSWAGEN	PASSAT B5 (3B2)	2.3 VR5 Syncro 4motion; 2.5 TDI Syncro 4motion; 2.8 V6 Syncro 4motion; 1.8 4motion; 1.9 TDI 4motion; 1.6; 1.8; 1.8 T; 1.9 TDI; 2.0; 2.0 4motion; 2.3 VR5; 2.5 TDI; 2.8 V6	ago-96	nov-00	4	AB6135AT	-	VW G052162A2 + 75W90 Gl4
VOLKSWAGEN	PASSAT B5 (3B2)	2.5 TDI Syncro 4motion; 1.9 TDI; 1.9 TDI 4motion; 2.0; 2.0 4motion; 2.5 TDI	lug-98	nov-00	5	AB6149AT	-	ESSO LT 71141
VOLKSWAGEN	PASSAT B5 Variant (3B5)	2.3 VR5 Syncro 4motion; 2.5 TDI Syncro 4motion; 2.8 V6 Syncro 4motion; 1.8 4motion; 1.9 TDI 4motion; 1.6; 1.8; 1.8 T; 1.9 TDI; 2.0; 2.0 4motion; 2.3 VR5; 2.5 TDI; 2.8 V6	mag-97	nov-00	4	AB6135AT	-	VW G052162A2 + 75W90 Gl4
VOLKSWAGEN	PASSAT B5 Variant (3B5)	2.5 TDI Syncro 4motion; 1.6; 1.8; 1.8 T; 1.9 TDI; 1.9 TDI 4motion; 2.0; 2.0 4motion; 2.3 VR5; 2.5 TDI; 2.8 V6	mag-97	nov-00	5	AB6149AT	-	ESSO LT 71141
VOLKSWAGEN	PASSAT B5.5 (3B3)	1.6; 1.8 T 20V; 1.9 TDI; 1.9 TDI 4motion; 2.0; 2.0 4motion; 2.0 TDI; 2.3 V5; 2.3 V5 4motion; 2.5 TDI; 2.5 TDI 4motion; 2.8 4motion; 4.0 W8 4motion	nov-00	mag-05	5	AB6149AT	-	ESSO LT 71141
VOLKSWAGEN	PASSAT B5.5 (3B3)	1.9 TDI; 2.0; 2.0 4motion; 2.8	nov-00	mag-05	4	AB6135AT	-	VW G052162A2 + 75W90 Gl4
VOLKSWAGEN	PASSAT B5.5 Variant (3B6)	1.6; 1.8 T 20V; 1.9 TDI; 1.9 TDI 4motion; 2.0; 2.0 4motion; 2.3 VR5; 2.3 VR5 4motion; 2.5 TDI; 2.5 TDI 4motion; 2.8 4motion; 4.0 W8 4motion	nov-00	mag-05	5	AB6149AT	-	ESSO LT 71141
VOLKSWAGEN	PASSAT B5.5 Variant (3B6)	1.9 TDI; 2.0; 2.0 4motion	nov-00	mag-05	4	AB6135AT	-	VW G052162A2 + 75W90 Gl4
VOLKSWAGEN	PASSAT B6 (3C2)	1.4 TSI; 1.4 TSI EcoFuel; 1.6; 1.6 FSI; 1.6 TDI; 1.8 TSI; 1.9 TDI; 2.0 BlueTDI; 2.0 FSI; 2.0 FSI 4motion; 2.0 TDI; 2.0 TDI 16V; 2.0 TDI 16V 4motion; 2.0 TDI 4motion; 2.0 TFSI; 3.2 FSI 4motion; 3.6 R36 4motion	mar-05	nov-10	7	AB6024AT	-	Meccatronica: VW G004000 Cambio: VW G052171
VOLKSWAGEN	PASSAT B6 (3C2)	1.6 FSI; 1.8 TSI; 1.9 TDI; 2.0 BlueTDI; 2.0 FSI; 2.0 FSI 4motion; 2.0 TDI; 2.0 TDI 16V; 2.0 TDI 16V 4motion; 2.0 TDI 4motion; 2.0 TFSI	mar-05	nov-10	6	AB6137AT	-	VW G055025A2
VOLKSWAGEN	PASSAT B6 (3C2)	1.6 FSI; 1.8 TSI; 1.9 TDI; 2.0 BlueTDI; 2.0 FSI; 2.0 TDI; 2.0 TDI 16V; 2.0 TDI 4motion; 2.0 TFSI; 3.2 FSI 4motion; 3.6 R36 4motion	mar-05	nov-10	6	AB6025AT + AB6026AT	-	VW G052182
VOLKSWAGEN	PASSAT B6 (3C2)	1.6; 1.6 FSI; 1.9 TDI; 2.0 FSI; 2.0 FSI 4motion; 2.0 TDI; 2.0 TDI 16V; 2.0 TDI 16V 4motion; 2.0 TDI 4motion; 2.0 TFSI; 3.2 FSI 4motion; 3.6 R36 4motion	mar-05	ago-10	5	AB6149AT	-	ESSO LT 71141
VOLKSWAGEN	PASSAT B6 (3C2)	1.9 TDI; 2.0 TDI; 2.0 TDI 16V; 2.0 TDI 16V 4motion; 2.0 TDI 4motion; 2.0 TFSI; 3.2 FSI 4motion; 3.6 R36 4motion	mar-05	nov-10	6	AB6025AT + AB6027AT	-	VW G052182
VOLKSWAGEN	PASSAT B6 (3C2)	3.2 FSI 4motion; 3.6 R36 4motion	nov-05	lug-10	6	AB6008AT	-	VW G055025A2
VOLKSWAGEN	PASSAT B6 Variant (3C5)	1.4 TSI; 1.4 TSI EcoFuel; 1.6; 1.6 FSI; 1.6 TDI; 1.8 TSI; 1.9 TDI; 2.0 BlueTDI; 2.0 FSI; 2.0 FSI 4motion; 2.0 TDI; 2.0 TDI 16V; 2.0 TDI 16V 4motion; 2.0 TDI 4motion; 2.0 TFSI; 3.2 FSI 4motion; 3.6 R36 4motion	ago-05	ott-11	7	AB6024AT	-	Meccatronica: VW G004000 Cambio: VW G052171

Marca / Brand:	Modello / Model:	Versioni / Version:	Da anno / From:	Ad anno / To:	Marce / Gears:	Codice AB PARTS		Lubrificante Consigliato
VOLKSWAGEN	PASSAT B6 Variant (3C5)	1.6 FSI; 1.8 TSI; 1.9 TDI; 2.0 BlueTDI; 2.0 FSI; 2.0 FSI 4motion; 2.0 TDI; 2.0 TDI 16V; 2.0 TDI 16V 4motion; 2.0 TDI 4motion; 2.0 TFSI	ago-05	ott-11	6	AB6137AT	-	VW G055025A2
VOLKSWAGEN	PASSAT B6 Variant (3C5)	1.6 FSI; 1.8 TSI; 1.9 TDI; 2.0 BlueTDI; 2.0 FSI; 2.0 TDI; 2.0 TDI 16V; 2.0 TDI 4motion; 2.0 TFSI; 3.2 FSI 4motion; 3.6 R36 4motion	ago-05	ott-11	6	AB6025AT + AB6026AT	-	VW G052182
VOLKSWAGEN	PASSAT B6 Variant (3C5)	1.6; 1.6 FSI; 1.9 TDI; 2.0 FSI; 2.0 FSI 4motion; 2.0 TDI; 2.0 TDI 16V; 2.0 TDI 16V 4motion; 2.0 TDI 4motion; 2.0 TFSI; 3.2 FSI 4motion; 3.6 R36 4motion	ago-05	nov-10	5	AB6149AT	-	ESSO LT 71141
VOLKSWAGEN	PASSAT B6 Variant (3C5)	1.9 TDI; 2.0 TDI; 2.0 TDI 16V; 2.0 TDI 16V 4motion; 2.0 TDI 4motion; 2.0 TFSI; 3.2 FSI 4motion; 3.6 R36 4motion	ago-05	nov-10	6	AB6025AT + AB6027AT	-	VW G052182
VOLKSWAGEN	PASSAT B6 Variant (3C5)	3.2 FSI 4motion	nov-05	nov-10	6	AB6008AT	-	VW G055025A2
VOLKSWAGEN	PASSAT B7 (362)	1.4 TSI; 1.4 TSI EcoFuel; 1.4 TSI MultiFuel; 1.6 TDI; 1.8 TSI; 2.0 TDI; 2.0 TDI 4motion; 2.0 TSI; 3.6 FSI 4motion	ago-10	dic-14	7	AB6024AT	-	Meccatronica: VW G004000 Cambio: VW G052171
VOLKSWAGEN	PASSAT B7 (362)	1.4 TSI; 1.4 TSI EcoFuel; 1.4 TSI MultiFuel; 1.8 TSI; 2.0 TDI; 2.0 TDI 4motion; 2.0 TSI; 3.6 FSI 4motion	ago-10	dic-14	6	AB6025AT + AB6027AT	-	VW G052182
VOLKSWAGEN	PASSAT B7 (362)	2.0 TDI; 2.0 TDI 4motion; 2.0 TSI; 3.6 FSI 4motion	ago-10	dic-14	6	AB6025AT + AB6026AT	-	VW G052182
VOLKSWAGEN	PASSAT B7 (362)	2.0 TSI	nov-10	dic-14	6	AB6137AT	-	VW G055025A2
VOLKSWAGEN	PASSAT B7 (A32, A33)	2.0 TDI	apr-11	giu-15	7	AB6024AT	-	Meccatronica: VW G004000 Cambio: VW G052171
VOLKSWAGEN	PASSAT B7 (A32, A33)	2.0 TDI	apr-11	giu-15	6	AB6025AT + AB6026AT	-	VW G052182
VOLKSWAGEN	PASSAT B7 Furgone/familiare (365)	1.4 TSI BlueMotion; 2.0 TDI BlueMotion; 2.0 TSI; 3.6 FSI 4motion	ago-10	dic-14	7	AB6024AT	-	Meccatronica: VW G004000 Cambio: VW G052171
VOLKSWAGEN	PASSAT B7 Furgone/familiare (365)	2.0 TDI BlueMotion; 2.0 TSI; 3.6 FSI 4motion	ago-10	dic-14	6	AB6025AT + AB6026AT	-	VW G052182
VOLKSWAGEN	PASSAT B7 Furgone/familiare (365)	2.0 TSI	nov-10	dic-14	6	AB6137AT	-	VW G055025A2
VOLKSWAGEN	PASSAT B7 Variant (365)	1.4 TSI; 1.4 TSI EcoFuel; 1.4 TSI MultiFuel; 1.6 TDI; 1.8 TSI; 2.0 TDI; 2.0 TDI 4motion; 2.0 TSI; 3.6 FSI 4motion	ago-10	dic-15	7	AB6024AT	-	Meccatronica: VW G004000 Cambio: VW G052171
VOLKSWAGEN	PASSAT B7 Variant (365)	1.4 TSI; 1.4 TSI EcoFuel; 1.4 TSI MultiFuel; 1.8 TSI; 2.0 TDI; 2.0 TDI 4motion; 2.0 TSI; 3.6 FSI 4motion	ago-10	dic-15	6	AB6025AT + AB6027AT	-	VW G052182
VOLKSWAGEN	PASSAT B7 Variant (365)	2.0 TDI; 2.0 TDI 4motion; 2.0 TSI; 3.6 FSI 4motion	ago-10	dic-15	6	AB6025AT + AB6026AT	-	VW G052182
VOLKSWAGEN	PASSAT B7 Variant (365)	2.0 TSI	nov-10	dic-15	6	AB6137AT	-	VW G055025A2
VOLKSWAGEN	PASSAT B8 (3G2, CB2)	1.4 GTE Hybrid	giu-15	In produzione	7	AB6029AT + AB6031AT *	AB6032AT *	VW G055529A2
VOLKSWAGEN	PASSAT B8 (3G2, CB2)	1.4 GTE Hybrid	giu-15	In produzione	7	AB6029AT + AB6031AT *	AB6032AT *	VW G055529A2
VOLKSWAGEN	PASSAT B8 (3G2, CB2)	1.4 GTE Hybrid; 1.4 TSI; 1.4 TSI 4motion; 1.5 TSI; 1.6 TDI; 1.8 TSI; 2.0 TDI; 2.0 TDI 4motion; 2.0 TSI; 2.0 TSI 4motion	ago-14	In produzione	7	AB6024AT	-	Meccatronica: VW G004000 Cambio: VW G052171
VOLKSWAGEN	PASSAT B8 Variant (3G5, CB5)	1.4 GTE Hybrid	giu-15	In produzione	7	AB6029AT + AB6031AT *	AB6032AT *	VW G055529A2

Marca / Brand:	Modello / Model:	Versioni / Version:	Da anno / From:	Ad anno / To:	Marce / Gears:	Codice AB PARTS		Lubrificante Consigliato
VOLKSWAGEN	PASSAT B8 Variant (3G5, CB5)	1.4 GTE Hybrid	giu-15	In produzione	7	AB6029AT + AB6031AT *	- AB6032AT *	VW G055529A2
VOLKSWAGEN	PASSAT B8 Variant (3G5, CB5)	1.4 GTE Hybrid; 1.4 TSI; 1.4 TSI 4motion; 1.5 TSI; 1.6 TDI; 1.8 TSI; 2.0 TDI; 2.0 TDI 4motion; 2.0 TSI; 2.0 TSI 4motion	ago-14	In produzione	7	AB6024AT	-	Meccatronica: VW G004000 Cambio: VW G052171
VOLKSWAGEN	PASSAT CC B6 (357)	1.4 TSI MultiFuel; 1.8 TSI; 2.0 BlueTDI; 2.0 TDI; 2.0 TDI 4motion; 2.0 TFSI; 2.0 TSI; 3.6 FSI 4motion	feb-08	gen-12	7	AB6024AT	-	Meccatronica: VW G004000 Cambio: VW G052171
VOLKSWAGEN	PASSAT CC B6 (357)	1.4 TSI MultiFuel; 1.8 TSI; 2.0 TDI; 2.0 TDI 4motion; 2.0 TFSI; 2.0 TSI; 3.6 FSI 4motion	feb-08	gen-12	6	AB6025AT + AB6027AT	-	VW G052182
VOLKSWAGEN	PASSAT CC B6 (357)	2.0 BlueTDI; 2.0 TDI; 2.0 TDI 4motion; 2.0 TFSI; 2.0 TSI	feb-08	gen-12	6	AB6137AT	-	VW G055025A2
VOLKSWAGEN	PASSAT CC B6 (357)	2.0 BlueTDI; 2.0 TDI; 2.0 TDI 4motion; 2.0 TFSI; 2.0 TSI; 3.6 FSI 4motion	feb-08	gen-12	6	AB6025AT + AB6026AT	-	VW G052182
VOLKSWAGEN	PHAETON (3D1, 3D2, 3D3, 3D4, 3D6, 3D7, 3D8, 3D9)	3.0 V6 TDI 4motion; 3.2 V6 4motion; 3.6 V6 4motion; 4.2 V8 4motion; 5.0 V10 TDI 4motion; 6.0 W12 4motion	nov-02	mar-16	6	AB6154AT *	AB6155AT *	DEXRON VI
VOLKSWAGEN	PHAETON (3D1, 3D2, 3D3, 3D4, 3D6, 3D7, 3D8, 3D9)	3.0 V6 TDI 4motion; 3.2 V6; 3.2 V6 4motion; 3.6 V6 4motion; 4.2 V8 4motion; 5.0 V10 TDI 4motion; 6.0 W12 4motion	apr-02	mar-16	6	AB6154AT *	AB6155AT *	DEXRON VI
VOLKSWAGEN	PHAETON (3D1, 3D2, 3D3, 3D4, 3D6, 3D7, 3D8, 3D9)	3.0 V6 TDI 4motion; 3.2 V6; 3.2 V6 4motion; 4.2 V8 4motion; 5.0 V10 TDI 4motion; 6.0 W12 4motion	apr-02	mar-16	5	AB6149AT	-	ESSO LT 71141
VOLKSWAGEN	POLO (6N2)	1.4; 1.4 16V	ott-99	set-01	4	AB6069AT	-	AISIN ATF-0T4
VOLKSWAGEN	POLO (9N_, 9A_)	1.2; 1.2 12V; 1.4 16V; 1.4 FSI; 1.4 TDI; 1.6 16V; 1.8 GTI; 1.8 GTI Cup Edition; 1.9 SDI; 1.9 TDI	ott-01	nov-09	6	AB6136AT	-	VW G055025A2
VOLKSWAGEN	POLO (9N_, 9A_)	1.4 16V	ott-01	mag-08	4	AB6069AT	-	AISIN ATF-0T4
VOLKSWAGEN	POLO IV Tre volumi (9A4, 9A2, 9N2, 9A6)	1.4	nov-02	apr-12	6	AB6136AT	-	VW G055025A2
VOLKSWAGEN	POLO IV Tre volumi (9A4, 9A2, 9N2, 9A6)	1.4	nov-02	apr-12	4	AB6069AT	-	AISIN ATF-0T4
VOLKSWAGEN	POLO V (6R1, 6C1)	1.0; 1.0 TSI; 1.2; 1.2 TDI; 1.2 TSI; 1.2 TSI 16V; 1.4; 1.4 BiFuel; 1.4 GTI; 1.4 TDI; 1.4 TSI; 1.6; 1.6 BiFuel; 1.6 TDI; 1.8 GTI; 2.0 R WRC	mar-09	mag-22	7	AB6024AT	-	Meccatronica: VW G004000 Cambio: VW G052171
VOLKSWAGEN	POLO V (6R1, 6C1)	1.6	gen-10	mag-22	6	AB6138AT *	AB6139AT *	VW G055025A2
VOLKSWAGEN	POLO V Tre volumi (602, 604, 612, 614)	1.4 TSI; 1.6	mag-10	mag-22	7	AB6024AT	-	Meccatronica: VW G004000 Cambio: VW G052171
VOLKSWAGEN	POLO V Tre volumi (602, 604, 612, 614)	1.6	mag-10	mag-22	6	AB6138AT *	AB6139AT *	VW G055025A2
VOLKSWAGEN	POLO Van (6R)	1.0; 1.0 TSI; 1.2; 1.2 BlueMotion; 1.2 TDI BlueMotion; 1.2 TSI; 1.2 TSI BlueMotion; 1.4; 1.4 TDI; 1.4 TSI; 1.6 TDI BlueMotion	mar-09	ott-17	7	AB6024AT	-	Meccatronica: VW G004000 Cambio: VW G052171
VOLKSWAGEN	POLO VI (AW1, BZ1, AE1)	1.0; 1.0 MPI; 1.0 TGI; 1.0 TSI; 1.5 TSI; 1.6 TDI; 2.0 GTI	giu-17	In produzione	7	AB6024AT	-	Meccatronica: VW G004000 Cambio: VW G052171
VOLKSWAGEN	POLO VI (AW1, BZ1, AE1)	2.0 GTI	nov-17	In produzione	6	AB6025AT + AB6026AT	-	VW G052182
VOLKSWAGEN	ROUTAN	3.6; 3.8; 4.0	set-08	dic-13	6	AB6022AT	-	MOPAR ATF +4
VOLKSWAGEN	SCIROCCO III (137, 138)	1.4 TSI; 2.0 R; 2.0 TDI; 2.0 TFSI; 2.0 TSI	mag-08	nov-17	7	AB6024AT	-	Meccatronica: VW G004000 Cambio: VW G052171
VOLKSWAGEN	SCIROCCO III (137, 138)	1.4 TSI; 2.0 R; 2.0 TDI; 2.0 TFSI; 2.0 TSI	mag-08	nov-17	6	AB6025AT + AB6027AT	-	VW G052182
VOLKSWAGEN	SCIROCCO III (137, 138)	2.0 R; 2.0 TDI; 2.0 TFSI; 2.0 TSI	mag-08	nov-17	6	AB6025AT + AB6026AT	-	VW G052182

Marca / Brand:	Modello / Model:	Versioni / Version:	Da anno / From :	Ad anno / To:	Marce / Gears:	Codice AB PARTS		Lubrificante Consigliato
VOLKSWAGEN	SCIROCCO Van (137)	1.4 TSi; 2.0 TDi	ago-08	mag-14	7	AB6024AT	-	Meccatronica: VW G004000 Cambio: VW G052171
VOLKSWAGEN	SCIROCCO Van (137)	2.0 TDi	ago-08	mag-14	6	AB6025AT + AB6026AT	-	VW G052182
VOLKSWAGEN	SHARAN (7M8, 7M9, 7M6)	1.8 T 20V; 1.9 TDi; 1.9 TDi 4motion; 2.0; 2.0 LPG; 2.0 TDi; 2.8 V6 24V; 2.8 V6 24V 4motion	set-95	mar-10	5	AB6072AT	-	ATF Type K17
VOLKSWAGEN	SHARAN (7N1, 7N2)	1.4 TSi; 2.0 TDi; 2.0 TDi 4motion; 2.0 TFSi	mag-10	lug-19	6	AB6025AT + AB6027AT	-	VW G052182
VOLKSWAGEN	SHARAN (7N1, 7N2)	1.4 TSi; 2.0 TDi; 2.0 TDi 4motion; 2.0 TFSi; 2.0 TSi	mag-10	nov-22	6	AB6025AT + AB6026AT	-	VW G052182
VOLKSWAGEN	SHARAN VAN (7N1, 7N2)	1.4 TSi; 2.0 TDi; 2.0 TSi	mag-10	nov-15	6	AB6025AT + AB6026AT	-	VW G052182
VOLKSWAGEN	TAIGO (CS1)	1.0 TSi; 1.5 TSi	set-21	In produzione	7	AB6024AT	-	Meccatronica: VW G004000 Cambio: VW G052171
VOLKSWAGEN	T-CROSS (C11, D31)	1.0 TSi; 1.6 TDi	dic-18	In produzione	7	AB6024AT	-	Meccatronica: VW G004000 Cambio: VW G052171
VOLKSWAGEN	TIGUAN (5N_)	1.4 TSi; 1.4 TSi 4motion; 2.0 TDi; 2.0 TDi 4motion; 2.0 TFSi 4motion; 2.0 TSi 4motion	set-07	lug-18	6	AB6025AT + AB6027AT	-	VW G052182
VOLKSWAGEN	TIGUAN (5N_)	1.4 TSi; 2.0 TDi 4motion; 2.0 TFSi 4motion; 2.0 TSi 4motion	set-07	lug-18	6	AB6025AT + AB6026AT	-	VW G052182
VOLKSWAGEN	TIGUAN (5N_)	2.0 TDi; 2.0 TDi 4motion; 2.0 TFSi 4motion; 2.0 TSi 4motion	set-07	lug-18	6	AB6008AT	-	VW G055025A2
VOLKSWAGEN	TIGUAN (5N_)	2.0 TDi; 2.0 TDi 4motion; 2.0 TFSi 4motion; 2.0 TSi 4motion	set-07	lug-18	7	AB6029AT + AB6031AT *	AB6032AT *	VW G055529A2
VOLKSWAGEN	TIGUAN (5N_)	2.0 TDi; 2.0 TDi 4motion; 2.0 TFSi 4motion; 2.0 TSi 4motion	set-07	lug-18	7	AB6029AT + AB6031AT *	AB6032AT *	VW G055529A2
VOLKSWAGEN	TIGUAN (AD1, AX1)	1.4 TSi; 1.4 TSi 4motion	gen-16	In produzione	6	AB6025AT + AB6026AT	-	VW G052182
VOLKSWAGEN	TIGUAN ALLSPACE (BW2, BJ2)	1.4 TSi; 1.4 TSi E100 Flex	giu-17	In produzione	6	AB6025AT + AB6026AT	-	VW G052182
VOLKSWAGEN	TIGUAN ALLSPACE (BW2, BJ2)	2.0 TSi; 2.0 TSi 4motion	mar-17	In produzione	7	AB6002AT	-	VW G055540A2
VOLKSWAGEN	TIGUAN VAN (5N_)	2.0 TDi 4motion	nov-07	lug-18	6	AB6025AT + AB6027AT	-	VW G052182
VOLKSWAGEN	TOUAREG (7LA, 7L6, 7L7)	2.5 R5 TDi; 3.0 TDi; 3.0 V6 TDi; 3.2 V6; 3.6 V6 FSi; 4.2 V8; 4.2 V8 FSi; 5.0 R50 TDi; 5.0 V10 TDi; 6.0 W12	ott-02	mag-10	6	AB6010AT	-	VW G055025A2
VOLKSWAGEN	TOUAREG (7P5, 7P6)	3.0 V6 TDi; 3.0 V6 TSi; 3.0 V6 TSi Hybrid; 3.6 V6 FSi; 4.2 V8 FSi; 4.2 V8 TDI	gen-10	mar-18	8	AB6011AT	-	VW G055540A2
VOLKSWAGEN	TOUAREG (CR7, RC8)	2.0 TFSi 4motion; 3.0 R 4motion; 3.0 TDi 4motion; 3.0 TSi 4motion	nov-17	In produzione	8	AB6169AT	-	ZF Lifeguard Fluid 8
VOLKSWAGEN	TOUAREG (CR7, RC8)	2.0 TFSi 4motion; 3.0 TDi 4motion; 3.0 TSi 4motion	nov-17	In produzione	8	AB6168AT	-	ZF Lifeguard Fluid 8
VOLKSWAGEN	TOUAREG (CR7, RC8)	2.0 TFSi 4motion; 3.0 TDi 4motion; 3.0 TSi 4motion; 4.0 V8 TDi 4motion	nov-17	In produzione	8	AB6174AT	-	ZF Lifeguard Fluid 8
VOLKSWAGEN	TOUAREG VAN (7P5)	3.0 TDi 4motion	mag-11	dic-14	8	AB6011AT	-	VW G055540A2

Marca / Brand:	Modello / Model:	Versioni / Version:	Da anno / From :	Ad anno / To:	Marce / Gears:	Codice AB PARTS		Lubrificante Consigliato
VOLKSWAGEN	TOURAN (1T1, 1T2)	1.4 TSI; 1.4 TSI EcoFuel; 1.6 FSI; 1.9 TDI; 2.0 FSI; 2.0 TDI; 2.0 TDI 16V	feb-03	mag-10	6	AB6025AT + AB6026AT	-	VW G052182
VOLKSWAGEN	TOURAN (1T1, 1T2)	1.4 TSI; 1.4 TSI EcoFuel; 1.6; 1.6 FSI; 1.9 TDI; 2.0 EcoFuel; 2.0 TDI; 2.0 TDI 16V	feb-03	mag-10	7	AB6024AT	-	Meccatronica: VW G004000 Cambio: VW G052171
VOLKSWAGEN	TOURAN (1T1, 1T2)	1.4 TSI; 1.4 TSI EcoFuel; 1.9 TDI; 2.0 TDI; 2.0 TDI 16V	feb-03	mag-10	6	AB6025AT + AB6027AT	-	VW G052182
VOLKSWAGEN	TOURAN (1T1, 1T2)	1.4 TSI; 1.6 FSI; 1.9 TDI; 2.0 FSI; 2.0 TDI; 2.0 TDI 16V	feb-03	mag-10	6	AB6137AT	-	VW G055025A2
VOLKSWAGEN	TOURAN (1T1, 1T2)	1.4 TSI; 1.6; 1.6 FSI; 1.9 TDI; 2.0 EcoFuel; 2.0 FSI; 2.0 TDI; 2.0 TDI 16V	feb-03	mag-10	6	AB6136AT	-	VW G055025A2
VOLKSWAGEN	TOURAN (1T3)	1.2 TSI; 1.4 TSI; 1.4 TSI EcoFuel; 1.6 TDI; 2.0 TDI	mag-10	mag-15	7	AB6024AT	-	Meccatronica: VW G004000 Cambio: VW G052171
VOLKSWAGEN	TOURAN (1T3)	1.4 TSI	mag-10	mag-15	6	AB6137AT	-	VW G055025A2
VOLKSWAGEN	TOURAN (1T3)	1.4 TSI; 1.4 TSI EcoFuel; 2.0 TDI	mag-10	mag-15	6	AB6025AT + AB6026AT	-	VW G052182
VOLKSWAGEN	TOURAN (1T3)	1.4 TSI; 1.4 TSI EcoFuel; 2.0 TDI	mag-10	mag-15	6	AB6025AT + AB6027AT	-	VW G052182
VOLKSWAGEN	TOURAN (5T1)	1.2 TSI; 1.4 TSI; 1.6 TDI; 1.8 TSI; 2.0 TDI	mag-15	In produzione	7	AB6024AT	-	Meccatronica: VW G004000 Cambio: VW G052171
VOLKSWAGEN	TOURAN VAN (1T1, 1T2)	1.9 TDI; 2.0 EcoFuel; 2.0 TDI; FSI	feb-03	mag-10	7	AB6024AT	-	Meccatronica: VW G004000 Cambio: VW G052171
VOLKSWAGEN	TOURAN VAN (1T1, 1T2)	1.9 TDI; 2.0 FSI; FSI	feb-03	gen-07	6	AB6137AT	-	VW G055025A2
VOLKSWAGEN	TOURAN VAN (1T1, 1T2)	2.0 FSI; FSI	feb-03	gen-07	6	AB6025AT + AB6026AT	-	VW G052182
VOLKSWAGEN	TOURAN VAN (1T3)	1.2 TSI; 1.4 TSI; 1.4 TSI EcoFuel; 1.6 TDI; 2.0 TDi	mag-10	mag-15	7	AB6024AT	-	Meccatronica: VW G004000 Cambio: VW G052171
VOLKSWAGEN	TOURAN VAN (1T3)	1.4 TSI	mag-10	mag-15	6	AB6137AT	-	VW G055025A2
VOLKSWAGEN	TOURAN VAN (1T3)	1.4 TSI; 1.4 TSI EcoFuel; 2.0 TDI	mag-10	mag-15	6	AB6025AT + AB6026AT	-	VW G052182
VOLKSWAGEN	TRANSPORTER T4 Autobus (70B, 70C, 7DB, 7DK, 70J, 70K, 7DC, 7	1.8; 1.9 D; 1.9 TD; 2.0; 2.4 D; 2.5; 2.5 TDI; 2.8 VR 6	set-90	giu-03	4	AB6132AT *	AB6133AT *	VW G052162A2 + 75W90 Gl4
VOLKSWAGEN	TRANSPORTER T4 Furgone (70A, 70H, 7DA, 7DH)	1.9 D; 1.9 TD; 2.0; 2.4 D; 2.5; 2.5 TDI	lug-90	apr-03	4	AB6132AT *	AB6133AT *	VW G052162A2 + 75W90 Gl4
VOLKSWAGEN	TRANSPORTER T4 Pianale piatto/Telaio (70E, 70L, 70M, 7DE, 7D	1.9 D; 1.9 TD; 2.0; 2.4 D; 2.5; 2.5 TDI	lug-90	apr-03	4	AB6132AT *	AB6133AT *	VW G052162A2 + 75W90 Gl4
VOLKSWAGEN	TRANSPORTER T5 Autobus (7HB, 7HJ, 7EB, 7EJ)	2.0 BiTDI; 2.0 BiTDI 4motion; 2.0 TDI; 2.0 TDI 4motion	set-09	ago-15	7	AB6029AT + AB6031AT *	- AB6032AT *	VW G055529A2
VOLKSWAGEN	TRANSPORTER T5 Autobus (7HB, 7HJ, 7EB, 7EJ)	2.0 BiTDI; 2.0 BiTDI 4motion; 2.0 TDI; 2.0 TDI 4motion	set-09	ago-15	7	AB6029AT + AB6031AT *	- AB6032AT *	VW G055529A2
VOLKSWAGEN	TRANSPORTER T5 Autobus (7HB, 7HJ, 7EB, 7EJ)	2.5 TDI; 2.5 TDI 4motion; 3.2 V6 4motion; VR6 3.2	apr-03	dic-09	6	AB6007AT	-	VW G055025A2
VOLKSWAGEN	TRANSPORTER T5 Furgone (7HA, 7HH, 7EA, 7EH)	2.0 BiTDI; 2.0 BiTDI 4motion; 2.0 TDI; 2.0 TDI 4motion	set-09	ago-15	7	AB6029AT + AB6031AT *	- AB6032AT *	VW G055529A2

Marca / Brand:	Modello / Model:	Versioni / Version:	Da anno / From:	Ad anno / To:	Marce / Gears:	Codice AB PARTS		Lubrificante Consigliato
VOLKSWAGEN	TRANSPORTER T5 Furgone (7HA, 7HH, 7EA, 7EH)	2.0 BitDI; 2.0 BitDI 4motion; 2.0 TDI; 2.0 TDI 4motion	set-09	ago-15	7	AB6029AT + AB6031AT *	- AB6032AT *	VW G055529A2
VOLKSWAGEN	TRANSPORTER T5 Furgone (7HA, 7HH, 7EA, 7EH)	2.5 TDI; 2.5 TDI 4motion; VR6 3.2; VR6 3.2 4motion	apr-03	nov-09	6	AB6007AT	-	VW G055025A2
VOLKSWAGEN	TRANSPORTER T5 Pianale piatto/Telaio (7JD, 7JE, 7JL, 7JY, 7J)	2.0 BitDI; 2.0 BitDI 4motion; 2.0 TDI; 2.0 TDI 4motion	set-09	ago-15	7	AB6029AT + AB6031AT *	- AB6032AT *	VW G055529A2
VOLKSWAGEN	TRANSPORTER T5 Pianale piatto/Telaio (7JD, 7JE, 7JL, 7JY, 7J)	2.0 BitDI; 2.0 BitDI 4motion; 2.0 TDI; 2.0 TDI 4motion	set-09	ago-15	7	AB6029AT + AB6031AT *	- AB6032AT *	VW G055529A2
VOLKSWAGEN	TRANSPORTER T5 Pianale piatto/Telaio (7JD, 7JE, 7JL, 7JY, 7J)	2.5 TDI; 2.5 TDI 4motion; VR6 3.2	apr-03	nov-09	6	AB6007AT	-	VW G055025A2
VOLKSWAGEN	TRANSPORTER T6 / CARAVELLE T6 Autobus (SGB, SGJ, SHB, SHJ)	2.0 TDI; 2.0 TDI 4motion	apr-15	dic-19	7	AB6029AT + AB6031AT *	- AB6032AT *	VW G055529A2
VOLKSWAGEN	TRANSPORTER T6 / CARAVELLE T6 Autobus (SGB, SGJ, SHB, SHJ)	2.0 TDI; 2.0 TDI 4motion	apr-15	dic-19	7	AB6029AT + AB6031AT *	- AB6032AT *	VW G055529A2
VOLKSWAGEN	TRANSPORTER T6 Furgone (SGA, SGH, SHA, SHH)	2.0 TDI; 2.0 TDI 4motion	apr-15	dic-19	7	AB6029AT + AB6031AT *	- AB6032AT *	VW G055529A2
VOLKSWAGEN	TRANSPORTER T6 Furgone (SGA, SGH, SHA, SHH)	2.0 TDI; 2.0 TDI 4motion	apr-15	dic-19	7	AB6029AT + AB6031AT *	- AB6032AT *	VW G055529A2
VOLKSWAGEN	TRANSPORTER T6 Pianale piatto/Telaio (SFD, SFE, SFL, SFZ, SJ)	2.0 TDI; 2.0 TDI 4motion	apr-15	nov-19	7	AB6029AT + AB6031AT *	- AB6032AT *	VW G055529A2
VOLKSWAGEN	TRANSPORTER T6 Pianale piatto/Telaio (SFD, SFE, SFL, SFZ, SJ)	2.0 TDI; 2.0 TDI 4motion	apr-15	nov-19	7	AB6029AT + AB6031AT *	- AB6032AT *	VW G055529A2
VOLKSWAGEN	T-ROC (A11, D11)	1.0 TSI; 1.5 TSI; 1.5 TSI 4motion; 1.6 TDI; 2.0 TDI; 2.0 TDI 4motion; 2.0 TSI 4motion	lug-17	In produzione	7	AB6024AT	-	Meccatronica: VW G004000 Cambio: VW G052171
VOLKSWAGEN	T-ROC Cabriolet (AC7, AC8)	1.0 TSI; 1.5 TSI	dic-19	In produzione	7	AB6024AT	-	Meccatronica: VW G004000 Cambio: VW G052171
VOLKSWAGEN	VENTO (1H2)	1.4; 1.6; 1.8; 1.9 D; 1.9 SDI; 1.9 TD; 1.9 TDI; 2.0; 2.8 VR6	nov-91	set-98	4	AB6132AT *	AB6133AT *	VW G052162A2 + 75W90 GL4
VOLKSWAGEN	VENTO (1H2)	1.6; 1.8; 1.9 TDI; 2.0; 2.8 VR6	nov-91	set-98	4	AB6134AT	-	VW G052162A2 + 75W90 GL4
VOLKSWAGEN	XL1 (6Z!)	0.8 TDI E-Hybrid	feb-14	In produzione	7	AB6024AT	-	Meccatronica: VW G004000 Cambio: VW G052171
VOLVO	C30 (533)	2.0; 2.0 D	ott-06	dic-12	6	AB6098AT + AB6100AT *	- AB6099AT *	FORD 1490763
VOLVO	C70 II Cabriolet (542)	2.0 D	gen-08	ott-09	6	AB6098AT + AB6100AT *	- AB6099AT *	FORD 1490763
VOLVO	S40 II (544)	1.6; 1.6 D; 1.8; 1.8 FlexFuel; 2.0; 2.0 D; 2.0 F; 2.4; 2.4 CDI; D2; D3; D4; D5; T5; T5 AWD	gen-04	dic-12	6	AB6098AT + AB6100AT *	- AB6099AT *	FORD 1490763
VOLVO	S60 II (134)	2.0 Polestar AWD; 3.0 T AWD	apr-14	dic-18	6	AB6009AT	-	AISIN AW-1
VOLVO	S60 II (134)	2.0 T; T4; T4F; T5; T5 AWD; T5 DRIVE	apr-10	dic-18	6	AB6098AT + AB6100AT *	- AB6099AT *	FORD 1490763
VOLVO	S60 II Cross Country (134)	T5 AWD	giu-16	dic-18	6	AB6098AT + AB6100AT *	- AB6099AT *	FORD 1490763

Marca / Brand:	Modello / Model:	Versioni / Version:	Da anno / From:	Ad anno / To:	Marce / Gears:	Codice AB PARTS		Lubrificante Consigliato
						AB6098AT + AB6100AT *	- AB6099AT *	
VOLVO	S80 II (124)	1.6 D DRIVE; 1.6 DRIVE; 2.0; 2.0 FlexFuel; 2.0 T; 2.0 TDi; 2.4 D; 2.5 T; 2.5 T FlexFuel; 3.2; 3.2 AWD; 4.4 V8 AWD; D5; D5 AWD; T4; T4F; T5; T6 AWD; D3 / D4	mar-06	dic-16	6	AB6098AT + AB6100AT *	- AB6099AT *	FORD 1490763
VOLVO	V40 Cross Country (526)	T4 GTDi	ott-12	dic-16	6	AB6098AT + AB6100AT *	- AB6099AT *	FORD 1490763
VOLVO	V40 Hatchback (525)	T4; T4 GTDi	mar-12	dic-16	6	AB6098AT + AB6100AT *	- AB6099AT *	FORD 1490763
VOLVO	V50 (545)	1.6; 1.6 D; 1.8; 1.8 BiFuel; 1.8 FlexFuel; 2.0; 2.0 D; 2.0 D4; 2.0 FlexFuel; 2.4; 2.4 Tdi; D2; D3; D4; D5; T5; T5 AWD	apr-04	dic-12	6	AB6098AT + AB6100AT *	- AB6099AT *	FORD 1490763
VOLVO	V60 I (155)	2.0 T; T5	lug-10	dic-14	6	AB6098AT + AB6100AT *	- AB6099AT *	FORD 1490763
VOLVO	V70 III (135)	1.6 DRIVE / D2; 2.0 T; T4; T4F; T5	set-09	dic-15	6	AB6098AT + AB6100AT *	- AB6099AT *	FORD 1490763
VOLVO	XC60 I SUV (156)	2.0 T; T5	dic-09	feb-17	6	AB6098AT + AB6100AT *	- AB6099AT *	FORD 1490763

DETTAGLIO PRODOTTI - FILTRI PER CAMBI AUTOMATICI

PRODUCT DETAILS - AUTOMATIC TRANSMISSION FILTERS

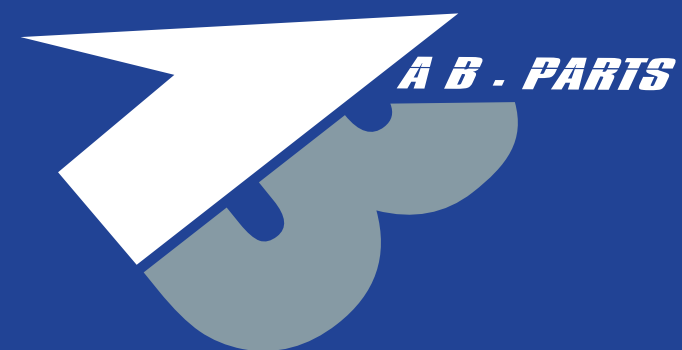

AB6001AT

AISIN 80-40 LE/LS, 81-40 LE/LS



Immagini non in scala

Altri riferimenti:

U440E, U441E

N. Rapporti	4
N. Fori Guarnizione	18

Note o Discriminanti:

-

Intervallo di manutenzione:

80000 / 4 ANNI

Composizione del kit:

Filtro + Guarnizione in gomma

Acquisto consigliato insieme a:

-

Alternative al prodotto:

-

AB6002AT

AISIN AQ450



Immagini non in scala

Altri riferimenti:

09P

N. Rapporti	8
N. Fori Guarnizione	9

Note o Discriminanti:

-

Intervallo di manutenzione:

60000 / 4 ANNI

Composizione del kit:

Filtro + Guarnizione gomma + Boccole (x9)

Acquisto consigliato insieme a:

-

Alternative al prodotto:

-

AB6003AT

AISIN AW03-70

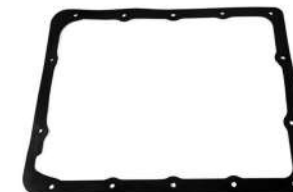

Immagini non in scala

Altri riferimenti:

A43DE, A46DE, A46DF, 03-71E / LE

N. Rapporti	4
N. Fori Guarnizione	14

Note o Discriminanti:

-

Intervallo di manutenzione:

80000 / 4 ANNI

Composizione del kit:

Filtro + Guarnizione in gomma

Acquisto consigliato insieme a:

-

Alternative al prodotto:

-

AB6004AT

AISIN AW60-40LE, AW60-42LE



Immagini non in scala

Altri riferimenti:

AF13, AF16, AF17

N. Rapporti	4
N. Fori Guarnizione	15

Note o Discriminanti:

-

Intervallo di manutenzione:

60000 / 4 ANNI

Composizione del kit:

Filtro + Guarnizione in gomma

Acquisto consigliato insieme a:

-

Alternative al prodotto:

-

AB6005AT

AISIN TF-60SN



Immagini non in scala

Altri riferimenti:

09G, GA6F21WA

N. Rapporti	6
N. Fori Guarnizione	8

Note o Discriminanti:

Pescante h.20mm

Intervallo di manutenzione:

60000 / 4 ANNI

Composizione del kit:

Filtro + Guarnizione in gomma + Boccole (x8)

Acquisto consigliato insieme a:

-

Alternative al prodotto:

-

AB6006AT

AISIN TF-60SN



Immagini non in scala

Altri riferimenti:

09G, GA6F21WA

N. Rapporti	6
N. Fori Guarnizione	8

Note o Discriminanti:

Pescante h. 25mm

Intervallo di manutenzione:

60000 / 4 ANNI

Composizione del kit:

Filtro + Guarnizione in gomma + Boccole (x8)

Acquisto consigliato insieme a:

-

Alternative al prodotto:

-

AB6007AT

AISIN TF-61SN



Immagini non in scala

Altri riferimenti:

09K

N. Rapporti	6
N. Fori Guarnizione	7

Note o Discriminanti:

Pescante piatto

Intervallo di manutenzione:

60000 / 4 ANNI

Composizione del kit:

Filtro + Guarnizione in gomma + Boccole (x7)

Acquisto consigliato insieme a:

-

Alternative al prodotto:

-

AB6008AT

AISIN TF-62SN, TF-63SN



Immagini non in scala

Altri riferimenti:

09M, AQ450

N. Rapporti	6
N. Fori Guarnizione	9

Note o Discriminanti:

Pescante h. 5mm

Intervallo di manutenzione:

60000 / 4 ANNI

Composizione del kit:

Filtro + Guarnizione gomma + Boccole (x9)

Acquisto consigliato insieme a:

-

Alternative al prodotto:

-

AB6009AT

AISIN TF-70SC, TF-80SC, TF-81SC



Immagini non in scala

Altri riferimenti:

AM6, AF21, AF40

N. Rapporti	6
N. Fori Guarnizione	11

Note o Discriminanti:

-

Intervallo di manutenzione:

80000 / 4 ANNI

Composizione del kit:

Filtro + Guarnizione in gomma

Acquisto consigliato insieme a:

-

Alternative al prodotto:

-

AB6010AT

AISIN TR-60SN



Con O'Ring



Immagini non in scala

Altri riferimenti:

09D

N. Rapporti	6
N. Fori Guarnizione	16

Note o Discriminanti:

-

Intervallo di manutenzione:

80000 / 4 ANNI

Composizione del kit:

Filtro + Guarnizione in gomma + Boccole (x16)

Acquisto consigliato insieme a:

-

Alternative al prodotto:

-

AB6011AT

AISIN TR-80SD



Immagini non in scala

Altri riferimenti:

0C8

N. Rapporti	8
N. Fori Guarnizione	12

Note o Discriminanti:

-

Intervallo di manutenzione:

80000 / 4 ANNI

Composizione del kit:

Filtro + Guarnizione in gomma

Acquisto consigliato insieme a:

-

Alternative al prodotto:

-

AB6012AT

AUDI MULTITRONIC



XI



XI

Immagini non in scala

Altri riferimenti:

01J, 01T

N. Rapporti	CVT
N. Fori Guarnizione	13 e 21

Note o Discriminanti:

Pescante tondo

Intervallo di manutenzione:

60000 / 4 ANNI

Composizione del kit:

Filtro + Guarnizione carta x2

Acquisto consigliato insieme a:

-

Alternative al prodotto:

-

AB6013AT

AUDI MULTITRONIC

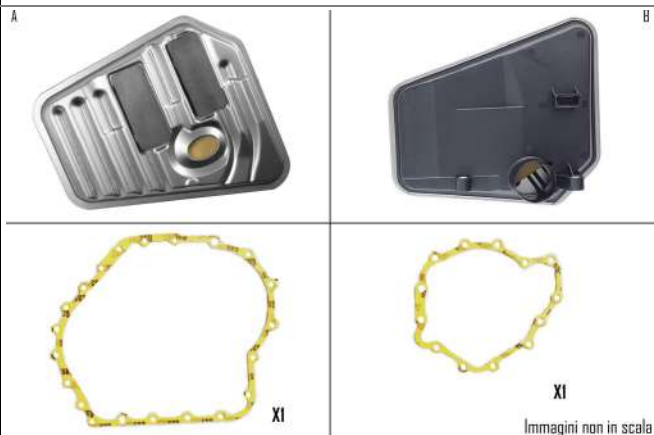

Immagini non in scala

Altri riferimenti:

01J, 01T

N. Rapporti

CVT

N. Fori Guarnizione

13 e 21

Note o Discriminanti:

Pescante ovale

Intervallo di manutenzione:

60000 / 4 ANNI

Composizione del kit:

Filtro + Guarnizione carta x2

Acquisto consigliato insieme a:

-

Alternative al prodotto:

-

AB6014AT

BMW GS7D36SG, GS7D36BG

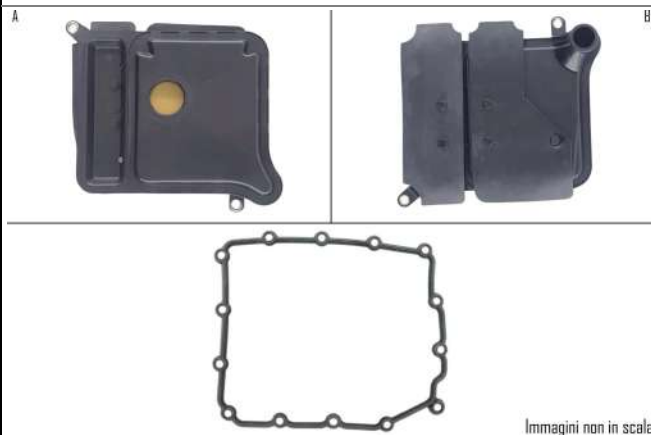

Immagini non in scala

Altri riferimenti:

-

N. Rapporti

7

N. Fori Guarnizione

14

Note o Discriminanti:

Filtro interno

Intervallo di manutenzione:

60000 / 4 ANNI

Composizione del kit:

Filtro + Guarnizione in gomma

Acquisto consigliato insieme a:

AB6015AT

Alternative al prodotto:

-

AB6015AT

BMW GS7D36SG, GS7D36BG



Immagini non in scala

Altri riferimenti:

-

N. Rapporti

7

N. Fori Guarnizione

-

Note o Discriminanti:

Filtro esterno

Intervallo di manutenzione:

60000 / 4 ANNI

Composizione del kit:

Cartuccia con OR installato + Tappo con OR installato + 1x Segeer

Acquisto consigliato insieme a:

AB6014AT

Alternative al prodotto:

-

AB6016AT

BMW VT1



Immagini non in scala

Altri riferimenti:

CVT16Z, GACVT16Z, GA6F21WA

N. Rapporti	CVT
N. Fori Guarnizione	13

Note o Discriminanti:

-

Intervallo di manutenzione:

80000 / 4 ANNI

Composizione del kit:

Filtro + Guarnizione in gomma

Acquisto consigliato insieme a:

-

Alternative al prodotto:

-

AB6017AT

BTR M78

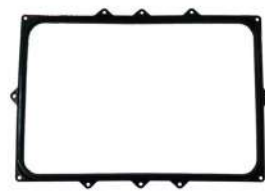

Immagini non in scala

Altri riferimenti:

DSI M78, 575R6

N. Rapporti	6
N. Fori Guarnizione	8

Note o Discriminanti:

-

Intervallo di manutenzione:

80000 / 4 ANNI

Composizione del kit:

Filtro + Guarnizione in gomma

Acquisto consigliato insieme a:

-

Alternative al prodotto:

-

AB6018AT

CHRYSLER 42RE, 44RE, 46RE, 47RE



XI



Immagini non in scala

Altri riferimenti:

-

N. Rapporti	4
N. Fori Guarnizione	14

Note o Discriminanti:

-

Intervallo di manutenzione:

60000 / 4 ANNI

Composizione del kit:

Filtro + Doppia guarnizione in gomma

Acquisto consigliato insieme a:

-

Alternative al prodotto:

-

AB6019AT

CHRYSLER 42RLE

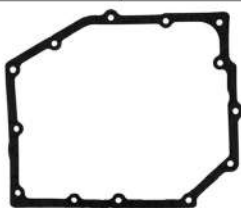

Immagini non in scala

Altri riferimenti:

-

N. Rapporti 4

N. Fori Guarnizione 13

Note o Discriminanti:

-

Intervallo di manutenzione:

60000 / 4 ANNI

Composizione del kit:

Filtro + Guarnizione in gomma

Acquisto consigliato insieme a:

-

Alternative al prodotto:

-

AB6020AT

CHRYSLER 45RFE

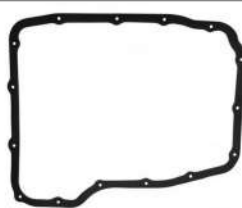

Immagini non in scala

Altri riferimenti:

-

N. Rapporti 4 / 5 / 6

N. Fori Guarnizione 15

Note o Discriminanti:

Veicoli dotati di 4x4

Intervallo di manutenzione:

48000 / 3 ANNI

Composizione del kit:

Filtro + Guarnizione in gomma + Filtro Spin On

Acquisto consigliato insieme a:

-

Alternative al prodotto:

-

AB6021AT

CHRYSLER 45RFE, 55RFE, 5-45RFE, 65RFE, 68RFE

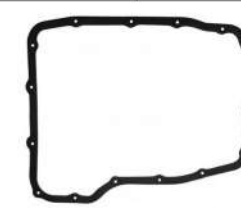

Immagini non in scala

Altri riferimenti:

-

N. Rapporti 4 / 5 / 6

N. Fori Guarnizione 15

Note o Discriminanti:

Veicoli dotati di 4x4

Intervallo di manutenzione:

48000 / 3 ANNI

Composizione del kit:

Filtro + Guarnizione gomma

Acquisto consigliato insieme a:

-

Alternative al prodotto:

-

AB6022AT

CHRYSLER 62TE



Immagini non in scala

Altri riferimenti:

62EA, 62TEA

N. Rapporti	6
N. Fori Guarnizione	12

Note o Discriminanti:

-

Intervallo di manutenzione:

80000 / 4 ANNI

Composizione del kit:

Filtro + Guarnizione in gomma

Acquisto consigliato insieme a:

-

Alternative al prodotto:

-

AB6023AT

CHRYSLER TF6, TF8



Immagini non in scala

Altri riferimenti:

A904, A998, A999, A500, A518, A618

N. Rapporti	3 / 4
N. Fori Guarnizione	14

Note o Discriminanti:

-

Intervallo di manutenzione:

60000 / 4 ANNI

Composizione del kit:

Filtro + Guarnizione in gomma

Acquisto consigliato insieme a:

-

Alternative al prodotto:

-

AB6024AT

DSG DQ200



lpz

Altri riferimenti:

OAM, OBM, OCG, OCW

N. Rapporti	7
N. Fori Guarnizione	-

Note o Discriminanti:

-

Intervallo di manutenzione:

60000 / 4 ANNI

Composizione del kit:

Cartuccia

Acquisto consigliato insieme a:

-

Alternative al prodotto:

-

AB6025AT

DSG DQ250



Immagini non in scala

Altri riferimenti:

02E, 0D9

N. Rapporti	6
N. Fori Guarnizione	-

Note o Discriminanti:

-

Intervallo di manutenzione:

60000 / 4 ANNI

Composizione del kit:

Cartuccia + O' Ring

Acquisto consigliato insieme a:

AB6026AT O AB6027AT

Alternative al prodotto:

-

AB6026AT

DSG DQ250



Immagini non in scala

Altri riferimenti:

02E

N. Rapporti	6
N. Fori Guarnizione	5

Note o Discriminanti:

-

Intervallo di manutenzione:

60000 / 4 ANNI

Composizione del kit:

Filtro + Guarnizione in gomma

Acquisto consigliato insieme a:

AB6025AT

Alternative al prodotto:

-

AB6027AT

DSG DQ250



Immagini non in scala

Altri riferimenti:

0D9

N. Rapporti	6
N. Fori Guarnizione	5

Note o Discriminanti:

Veicoli dotati di 4x4

Intervallo di manutenzione:

60000 / 4 ANNI

Composizione del kit:

Filtro + Guarnizione in gomma

Acquisto consigliato insieme a:

AB6025AT

Alternative al prodotto:

-

AB6028AT

DSG DQ380



Guarnizione non prevista

Immagini non in scala

Altri riferimenti:

ODE

N. Rapporti

7

N. Fori Guarnizione

-

Note o Discriminanti:

-

Intervallo di manutenzione:

60000 / 4 ANNI

Composizione del kit:

Filtro

Acquisto consigliato insieme a:

AB6031AT

Alternative al prodotto:

-

AB6029AT

DSG DQ500



Guarnizione non prevista

Immagini non in scala

Altri riferimenti:

OBH

N. Rapporti

7

N. Fori Guarnizione

-

Note o Discriminanti:

-

Intervallo di manutenzione:

60000 / 4 ANNI

Composizione del kit:

Filtro

Acquisto consigliato insieme a:

AB6031AT

Alternative al prodotto:

-

AB6030AT

DSG DQ500



Guarnizione non prevista

Immagini non in scala

Altri riferimenti:

OBT

N. Rapporti

7

N. Fori Guarnizione

-

Note o Discriminanti:

-

Intervallo di manutenzione:

60000 / 4 ANNI

Composizione del kit:

Filtro

Acquisto consigliato insieme a:

AB6031AT

Alternative al prodotto:

-

AB6031AT

DSG DQ500, DQ380, DQ400E



Immagini non in scala

Altri riferimenti:

OBH, OBT, ODE, OGC

N. Rapporti	7
N. Fori Guarnizione	-

Note o Discriminanti:

-

Intervallo di manutenzione:

60000 / 4 ANNI

Composizione del kit:

Cartuccia + O' Ring

Acquisto consigliato insieme a:

AB6028AT o AB6029AT o AB6030AT

Alternative al prodotto:

AB6032AT

AB6032AT

DSG DQ500, DQ380, DQ400E



Immagini non in scala

Altri riferimenti:

OBH, OBT, ODE, OGC

N. Rapporti	7
N. Fori Guarnizione	-

Note o Discriminanti:

-

Intervallo di manutenzione:

60000 / 4 ANNI

Composizione del kit:

Cartuccia + O' Ring + Calotta

Acquisto consigliato insieme a:

-

Alternative al prodotto:

AB6031AT

AB6033AT

FORD 4F27E



Immagini non in scala

Altri riferimenti:

FN4AEL, J39A

N. Rapporti	4
N. Fori Guarnizione	20

Note o Discriminanti:

Pescante h. 15mm

Intervallo di manutenzione:

80000 / 4 ANNI

Composizione del kit:

Filtro + Guarnizione in gomma

Acquisto consigliato insieme a:

-

Alternative al prodotto:

-

AB6034AT

FORD FNR5



Altri riferimenti:

MAZDA 5F27E

N. Rapporti	5
N. Fori Guarnizione	20

Note o Discriminanti:

Pescante h. 34mm

Intervallo di manutenzione:

80000 / 4 ANNI

Composizione del kit:

Filtro + Guarnizione in gomma

Acquisto consigliato insieme a:

-

Alternative al prodotto:

-

AB6035AT

FORD 8F24

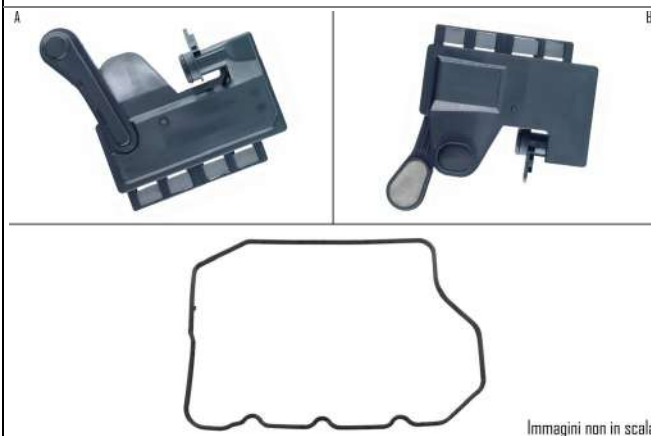

Altri riferimenti:

-

N. Rapporti	8
N. Fori Guarnizione	-

Note o Discriminanti:

Filtro interno - Veicoli con Start&Stop

Intervallo di manutenzione:

80000 / 4 ANNI

Composizione del kit:

Filtro + Guarnizione in gomma

Acquisto consigliato insieme a:

AB6036AT

Alternative al prodotto:

-

AB6036AT

FORD 8F24



Altri riferimenti:

-

N. Rapporti	8
N. Fori Guarnizione	-

Note o Discriminanti:

Filtro esterno

Intervallo di manutenzione:

80000 / 4 ANNI

Composizione del kit:

Cartuccia con OR installato + Tappo con OR installato

Acquisto consigliato insieme a:

AB6035AT

Alternative al prodotto:

-

AB6037AT

FORD CFT23



Altri riferimenti:

-

N. Rapporti

CVT

N. Fori Guarnizione

-

Note o Discriminanti:

-

Intervallo di manutenzione:

80000 / 4 ANNI

Composizione del kit:

Cartuccia

Acquisto consigliato insieme a:

AB6038AT

Alternative al prodotto:

-

AB6038AT

FORD CFT23



Altri riferimenti:

-

N. Rapporti

CVT

N. Fori Guarnizione

-

Note o Discriminanti:

-

Intervallo di manutenzione:

80000 / 4 ANNI

Composizione del kit:

Filtro

Acquisto consigliato insieme a:

AB6037AT

Alternative al prodotto:

-

AB6039AT

FORD GM 9T45, 9T50, 9T60, 9T65



Altri riferimenti:

-

N. Rapporti

9

N. Fori Guarnizione

-

Note o Discriminanti:

Filtro interno

Intervallo di manutenzione:

80000 / 4 ANNI

Composizione del kit:

Filtro + Guarnizione in gomma

Acquisto consigliato insieme a:

AB6040AT

Alternative al prodotto:

-

AB6040AT

FORD GM 9T45, 9T50, 9T60, 9T65



Altri riferimenti:

-

N. Rapporti	9
-------------	---

N. Fori Guarnizione	-
---------------------	---

Note o Discriminanti:

Filtro esterno

Intervallo di manutenzione:

80000 / 4 ANNI

Composizione del kit:

Cartuccia + O' Ring

Acquisto consigliato insieme a:

AB6039AT

Alternative al prodotto:

-

AB6041AT

GM 10R60, 10R80



Altri riferimenti:

-

N. Rapporti	10
-------------	----

N. Fori Guarnizione	18 + 1
---------------------	--------

Note o Discriminanti:

Filtro interno

Intervallo di manutenzione:

80000 / 4 ANNI

Composizione del kit:

Filtro + Guarnizione in metallo

Acquisto consigliato insieme a:

AB6042AT

Alternative al prodotto:

-

AB6042AT

GM 10R60, 10R80



Altri riferimenti:

-

N. Rapporti	10
-------------	----

N. Fori Guarnizione	-
---------------------	---

Note o Discriminanti:

Filtro esterno

Intervallo di manutenzione:

80000 / 4 ANNI

Composizione del kit:

Cartuccia + Doppio O' Ring

Acquisto consigliato insieme a:

AB6041AT

Alternative al prodotto:

-

AB6043AT

GM 4L30E



Immagini non in scala

Altri riferimenti:

AR25, AR35

N. Rapporti	4
N. Fori Guarnizione	16

Note o Discriminanti:

-

Intervallo di manutenzione:

80000 / 4 ANNI

Composizione del kit:

Filtro + Guarnizione gomma

Acquisto consigliato insieme a:

-

Alternative al prodotto:

-

AB6044AT

ZF PDK 8DT80A



Immagini non in scala

Altri riferimenti:

1.106.081

N. Rapporti	8
N. Fori Guarnizione	13

Note o Discriminanti:

-

Intervallo di manutenzione:

80000 / 4 ANNI

Composizione del kit:

Filtro + Guarnizione in gomma

Acquisto consigliato insieme a:

-

Alternative al prodotto:

-

AB6045AT

GM 4L60E, 4L65E

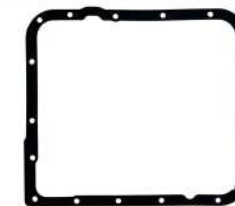

Immagini non in scala

Altri riferimenti:

-

N. Rapporti	4
N. Fori Guarnizione	16

Note o Discriminanti:

-

Intervallo di manutenzione:

80000 / 4 ANNI

Composizione del kit:

Filtro + Guarnizione in gomma

Acquisto consigliato insieme a:

-

Alternative al prodotto:

-

AB6046AT

GM 5L40E



Altri riferimenti:

A5S 390R, MR, XF, TZ, YY, WG, WZ, VT, WB

N. Rapporti 5

N. Fori Guarnizione 22

Note o Discriminanti:

Attacco H. 33mm

Intervallo di manutenzione:

80000 / 4 ANNI

Composizione del kit:

Filtro + Guarnizione in metallo

Acquisto consigliato insieme a:

-

Alternative al prodotto:

-

AB6047AT

GM 5L40E



Altri riferimenti:

A5S 390R, MR, XF, TZ, YY, WG, WZ, VT, WB

N. Rapporti 5

N. Fori Guarnizione 22

Note o Discriminanti:

Attacco H. 25mm

Intervallo di manutenzione:

80000 / 4 ANNI

Composizione del kit:

Filtro + Guarnizione in metallo

Acquisto consigliato insieme a:

-

Alternative al prodotto:

-

AB6048AT

GM 5L40E



Altri riferimenti:

A5S 390R, MR, XF, TZ, YY, WG, WZ, VT, WB

N. Rapporti 5

N. Fori Guarnizione 22

Note o Discriminanti:

Pescante con distanziale

Intervallo di manutenzione:

80000 / 4 ANNI

Composizione del kit:

Filtro + Guarnizione in metallo

Acquisto consigliato insieme a:

-

Alternative al prodotto:

-

AB6049AT

GM 6L45

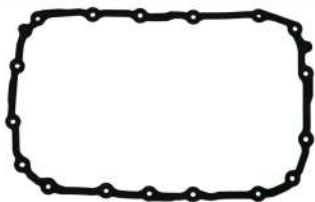

Immagini non in scala

Altri riferimenti:

6L45E, 6L45R, GA6L45R

N. Rapporti	6
N. Fori Guarnizione	17

Note o Discriminanti:

-

Intervallo di manutenzione:

80000 / 4 ANNI

Composizione del kit:

Filtro + Guarnizione in gomma

Acquisto consigliato insieme a:

-

Alternative al prodotto:

-

AB6050AT

GM 6T30, 6T31



Immagini non in scala

Altri riferimenti:

Gen. 3

N. Rapporti	6
N. Fori Guarnizione	-

Note o Discriminanti:

Mandata olio laterale

Intervallo di manutenzione:

60000 / 4 ANNI

Composizione del kit:

Filtro + Guarnizione in gomma

Acquisto consigliato insieme a:

-

Alternative al prodotto:

-

AB6051AT

GM 6T30, 6T30E



Immagini non in scala

Altri riferimenti:

MH9; Gen. 1 / 2

N. Rapporti	6
N. Fori Guarnizione	-

Note o Discriminanti:

Mandata olio centrale

Intervallo di manutenzione:

80000 / 4 ANNI

Composizione del kit:

Filtro + Guarnizione in gomma

Acquisto consigliato insieme a:

-

Alternative al prodotto:

-

AB6052AT

GM 6T40, 6T45

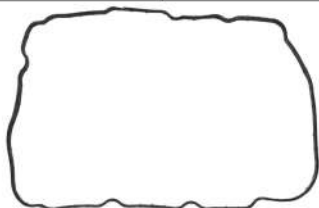

Immagini non in scala

Altri riferimenti:

Gen. 1 / 2

N. Rapporti	6
N. Fori Guarnizione	-

Note o Discriminanti:

-

Intervallo di manutenzione:

80000 / 4 ANNI

Composizione del kit:

Filtro + Guarnizione in gomma

Acquisto consigliato insieme a:

-

Alternative al prodotto:

-

AB6053AT

GM VT40

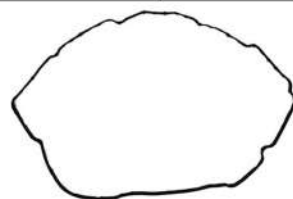

Immagini non in scala

Altri riferimenti:

CVT250

N. Rapporti	CVT
N. Fori Guarnizione	-

Note o Discriminanti:

Filtro esterno

Intervallo di manutenzione:

80000 / 4 ANNI

Composizione del kit:

Filtro + Guarnizione in gomma

Acquisto consigliato insieme a:

AB6054AT

Alternative al prodotto:

-

AB6054AT

GM VT40



Immagini non in scala

Altri riferimenti:

CVT250

N. Rapporti	CVT
N. Fori Guarnizione	-

Note o Discriminanti:

Filtro interno

Intervallo di manutenzione:

80000 / 4 ANNI

Composizione del kit:

Cartuccia + O' Ring

Acquisto consigliato insieme a:

AB6053AT

Alternative al prodotto:

-

AB6055AT

HYUNDAI A6GF1-2

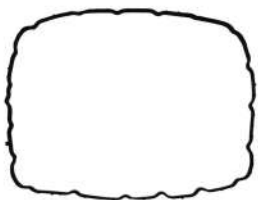

Immagini non in scala

Altri riferimenti:

-

N. Rapporti 6

N. Fori Guarnizione -

Note o Discriminanti:

-

Intervallo di manutenzione:

80000 / 4 ANNI

Composizione del kit:

Filtro + Guarnizione in gomma

Acquisto consigliato insieme a:

-

Alternative al prodotto:

-

AB6056AT

HYUNDAI A6LF1, A6LF2, A6LF3



Immagini non in scala

Altri riferimenti:

-

N. Rapporti 6

N. Fori Guarnizione 19

Note o Discriminanti:

-

Intervallo di manutenzione:

80000 / 4 ANNI

Composizione del kit:

Filtro + Guarnizione in gomma

Acquisto consigliato insieme a:

-

Alternative al prodotto:

-

AB6057AT

HYUNDAI A6MF1, A6MF2, A6GF1

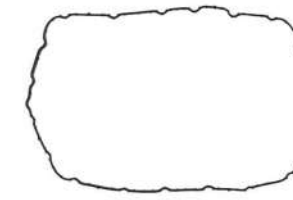

Immagini non in scala

Altri riferimenti:

-

N. Rapporti 6

N. Fori Guarnizione -

Note o Discriminanti:

-

Intervallo di manutenzione:

80000 / 4 ANNI

Composizione del kit:

Filtro + Guarnizione in gomma

Acquisto consigliato insieme a:

-

Alternative al prodotto:

-

AB6058AT

HYUNDAI A8MF1, A8F27



Immagini non in scala

Altri riferimenti:

-

N. Rapporti 8

N. Fori Guarnizione -

Note o Discriminanti:

-

Intervallo di manutenzione:

80000 / 4 ANNI

Composizione del kit:

Filtro + Guarnizione in gomma

Acquisto consigliato insieme a:

-

Alternative al prodotto:

-

AB6059AT

JATCO F4A-EL
FORD F-4EAT

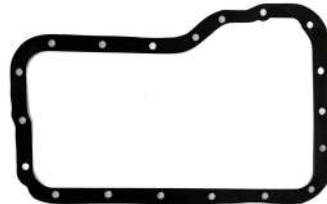

Immagini non in scala

Altri riferimenti:

-

N. Rapporti 4

N. Fori Guarnizione 19

Note o Discriminanti:

-

Intervallo di manutenzione:

60000 / 4 ANNI

Composizione del kit:

Filtro + Guarnizione in gomma

Acquisto consigliato insieme a:

-

Alternative al prodotto:

-

AB6060AT

JATCO JF011E

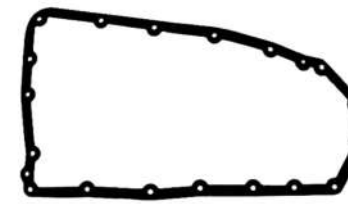

Immagini non in scala

Altri riferimenti:

REOF10A, REOF10B

N. Rapporti CVT

N. Fori Guarnizione 20

Note o Discriminanti:

Filtro interno -Pescante rotondo h.41mm

Intervallo di manutenzione:

80000 / 4 ANNI

Composizione del kit:

Filtro + Guarnizione in gomma

Acquisto consigliato insieme a:

AB6063AT

Alternative al prodotto:

-

AB6061AT

JATCO JF011E

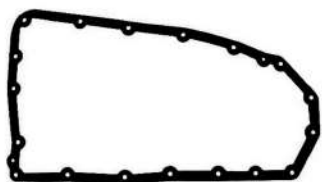

Immagini non in scala

Altri riferimenti:

REOF10A, REOF10B

N. Rapporti	CVT
N. Fori Guarnizione	20

Note o Discriminanti:

Filtro interno - Pescante quadrato h. 13mm

Intervallo di manutenzione:

80000 / 4 ANNI

Composizione del kit:

Filtro + Guarnizione in gomma

Acquisto consigliato insieme a:

AB6063AT

Alternative al prodotto:

-

AB6062AT

JATCO JF011E

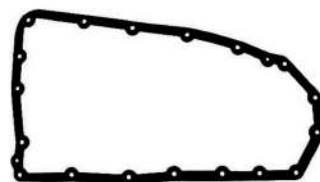

Immagini non in scala

Altri riferimenti:

REOF10A, REOF10B

N. Rapporti	CVT
N. Fori Guarnizione	20

Note o Discriminanti:

Filtro interno - Pescante quadrato h. 22mm

Intervallo di manutenzione:

80000 / 4 ANNI

Composizione del kit:

Filtro + Guarnizione in gomma

Acquisto consigliato insieme a:

AB6063AT

Alternative al prodotto:

-

AB6063AT

JATCO JF011E



Immagini non in scala

Altri riferimenti:

REOF10A, REOF10B

N. Rapporti	CVT
N. Fori Guarnizione	-

Note o Discriminanti:

Filtro esterno

Intervallo di manutenzione:

80000 / 4 ANNI

Composizione del kit:

Cartuccia + O' Ring

Acquisto consigliato insieme a:

AB6060AT o AB6061AT o AB6062AT

Alternative al prodotto:

-

AB6064AT

JATCO JF015E



Altri riferimenti:

CV7 X-TRONIC, REOF11A

N. Rapporti	CVT
-------------	-----

N. Fori Guarnizione	-
---------------------	---

Note o Discriminanti:

-

Intervallo di manutenzione:

80000 / 4 ANNI

Composizione del kit:

Cartuccia + O' Ring

Acquisto consigliato insieme a:

AB6065AT o AB6066AT o AB6067AT o ATF6068AT

Alternative al prodotto:

-

AB6065AT

JATCO JF015E, JF016E, JF017E, JF018E, JF019E



Altri riferimenti:

CV7 X-TRONIC, REOF11A, F1CJB

N. Rapporti	CVT
-------------	-----

N. Fori Guarnizione	15
---------------------	----

Note o Discriminanti:

-

Intervallo di manutenzione:

80000 / 4 ANNI

Composizione del kit:

Filtro + Guarnizione in gomma

Acquisto consigliato insieme a:

AB6064AT

Alternative al prodotto:

-

AB6066AT

JATCO JF016E, JF017E

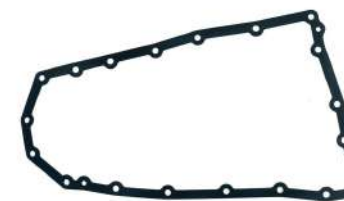

Altri riferimenti:

REOF10A, REOF10D, REOF10E

N. Rapporti	CVT
-------------	-----

N. Fori Guarnizione	21
---------------------	----

Note o Discriminanti:

Pescante basso centrale

Intervallo di manutenzione:

80000 / 4 ANNI

Composizione del kit:

Filtro + Guarnizione in gomma

Acquisto consigliato insieme a:

AB6064AT

Alternative al prodotto:

-

AB6067AT

JATCO JF016E, JF017E, JF018E

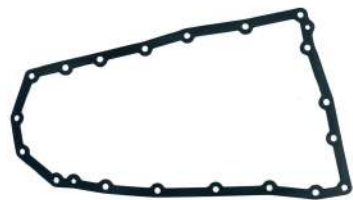

Immagini non in scala

Altri riferimenti:

CVT8

N. Rapporti	CVT
N. Fori Guarnizione	21

Note o Discriminanti:

Pescante basso laterale

Intervallo di manutenzione:

80000 / 4 ANNI

Composizione del kit:

Filtro + Guarnizione in gomma

Acquisto consigliato insieme a:

AB6064AT

Alternative al prodotto:

-

AB6068AT

JATCO JF019E

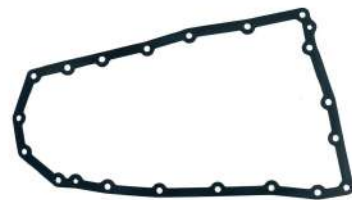

Immagini non in scala

Altri riferimenti:

REOF10J

N. Rapporti	CVT
N. Fori Guarnizione	21

Note o Discriminanti:

Pescante alto

Intervallo di manutenzione:

80000 / 4 ANNI

Composizione del kit:

Filtro + Guarnizione in gomma

Acquisto consigliato insieme a:

AB6064AT

Alternative al prodotto:

-

AB6069AT

JATCO JF404E



Immagini non in scala

Altri riferimenti:

-

N. Rapporti	4
N. Fori Guarnizione	17

Note o Discriminanti:

Per applicazioni da 07.1999

Intervallo di manutenzione:

80000 / 4 ANNI

Composizione del kit:

Filtro + Guarnizione in gomma

Acquisto consigliato insieme a:

-

Alternative al prodotto:

-

AB6070AT

JATCO JF506E



Immagini non in scala

Altri riferimenti:

RE5F01A, 5F31J, JA5A-EL

N. Rapporti	5
N. Fori Guarnizione	20

Note o Discriminanti:

Pescante rotondo h.23mm

Intervallo di manutenzione:

80000 / 4 ANNI

Composizione del kit:

Filtro + Guarnizione in gomma

Acquisto consigliato insieme a:

-

Alternative al prodotto:

-

AB6071AT

JATCO JF506E



Immagini non in scala

Altri riferimenti:

F5A5, 09A

N. Rapporti	5
N. Fori Guarnizione	20

Note o Discriminanti:

Pescante quadrato h.17mm

Intervallo di manutenzione:

80000 / 4 ANNI

Composizione del kit:

Filtro + Guarnizione in gomma

Acquisto consigliato insieme a:

-

Alternative al prodotto:

-

AB6072AT

JATCO JF506E



Immagini non in scala

Altri riferimenti:

F5A5, 09A

N. Rapporti	5
N. Fori Guarnizione	20

Note o Discriminanti:

Pescante quadrato h.33mm

Intervallo di manutenzione:

80000 / 4 ANNI

Composizione del kit:

Filtro + Guarnizione in gomma

Acquisto consigliato insieme a:

-

Alternative al prodotto:

-

AB6073AT

JEEP DFT850RE



Immagini non in scala

Altri riferimenti:

-

N. Rapporti	8
N. Fori Guarnizione	13

Note o Discriminanti:

-

Intervallo di manutenzione:

80000 / 4 ANNI

Composizione del kit:

Filtro + Guarnizione in metallo

Acquisto consigliato insieme a:

-

Alternative al prodotto:

-

AB6074AT

MAZDA SKYACTIVE DRIVE



Immagini non in scala

Altri riferimenti:

JATCO FW6A-EL, GW6A-EL

N. Rapporti	6
N. Fori Guarnizione	16

Note o Discriminanti:

-

Intervallo di manutenzione:

80000 / 4 ANNI

Composizione del kit:

Filtro + Guarnizione in gomma

Acquisto consigliato insieme a:

-

Alternative al prodotto:

-

AB6075AT

MAZDA SKYACTIVE DRIVE



Immagini non in scala

Altri riferimenti:

CW6A-EL, EW6A-EL

N. Rapporti	6
N. Fori Guarnizione	16

Note o Discriminanti:

-

Intervallo di manutenzione:

80000 / 4 ANNI

Composizione del kit:

Filtro + Guarnizione in gomma

Acquisto consigliato insieme a:

-

Alternative al prodotto:

-

AB6076AT

MB 4G-Tronic



Immagini non in scala

Altri riferimenti:

722.3, 722.4

N. Rapporti	4
N. Fori Guarnizione	-

Note o Discriminanti:

Pescante stretto

Intervallo di manutenzione:

60000 / 4 ANNI

Composizione del kit:

Filtro + Guarnizione in gomma

Acquisto consigliato insieme a:

-

Alternative al prodotto:

-

AB6077AT

MB 4G-Tronic



Immagini non in scala

Altri riferimenti:

722.5

N. Rapporti	4
N. Fori Guarnizione	-

Note o Discriminanti:

Pescante largo

Intervallo di manutenzione:

50000 / 3 ANNI

Composizione del kit:

Filtro + Guarnizione in gomma

Acquisto consigliato insieme a:

-

Alternative al prodotto:

-

AB6078AT

MB 5G-TRONIC



Immagini non in scala

Altri riferimenti:

722.6

N. Rapporti	5
N. Fori Guarnizione	-

Note o Discriminanti:

-

Intervallo di manutenzione:

50000 / 3 ANNI

Composizione del kit:

Filtro + Guarnizione in gomma

Acquisto consigliato insieme a:

-

Alternative al prodotto:

-

AB6079AT

MB 5G-TRONIC



Immagini non in scala

Altri riferimenti:

722.6

N. Rapporti 5

N. Fori Guarnizione -

Note o Discriminanti:

Per applicazioni Porsche

Intervallo di manutenzione:

50000 / 3 ANNI

Composizione del kit:

Filtro + Guarnizione in gomma

Acquisto consigliato insieme a:

-

Alternative al prodotto:

-

AB6080AT

MB 7G-DCT

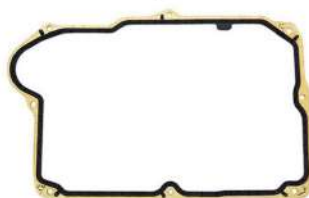

Immagini non in scala

Altri riferimenti:

724.0, K7A240, K7A350, K7X350, K7X400

N. Rapporti 7

N. Fori Guarnizione 8

Note o Discriminanti:

Filtro interno

Intervallo di manutenzione:

50000 / 3 ANNI

Composizione del kit:

Filtro + Guarnizione in metallo

Acquisto consigliato insieme a:

AB6081AT

Alternative al prodotto:

-

AB6081AT

MB 7G-DCT



lpz

Altri riferimenti:

724.0, K7A240, K7A350, K7X350, K7X400

N. Rapporti 7

N. Fori Guarnizione -

Note o Discriminanti:

Filtro esterno

Intervallo di manutenzione:

50000 / 3 ANNI

Composizione del kit:

Cartuccia + O' Ring

Acquisto consigliato insieme a:

AB6080AT

Alternative al prodotto:

-

AB6082AT

MB 7G-TRONIC PLUS



Immagini non in scala

Altri riferimenti:

722.9

N. Rapporti	7
N. Fori Guarnizione	-

Note o Discriminanti:

-

Intervallo di manutenzione:

50000 / 3 ANNI

Composizione del kit:

Filtro + Guarnizione in gomma

Acquisto consigliato insieme a:

-

Alternative al prodotto:

-

AB6083AT

MB 7G-TRONIC PLUS



Immagini non in scala

Altri riferimenti:

722.9

N. Rapporti	7
N. Fori Guarnizione	-

Note o Discriminanti:

-

Intervallo di manutenzione:

50000 / 3 ANNI

Composizione del kit:

Filtro + Guarnizione in gomma

Acquisto consigliato insieme a:

-

Alternative al prodotto:

-

AB6084AT

MB 7G-TRONIC PLUS



Immagini non in scala

Altri riferimenti:

722.9

N. Rapporti	7
N. Fori Guarnizione	-

Note o Discriminanti:

-

Intervallo di manutenzione:

50000 / 3 ANNI

Composizione del kit:

Filtro + Guarnizione in gomma

Acquisto consigliato insieme a:

-

Alternative al prodotto:

-

AB6085AT

MB 7G-TRONIC PLUS

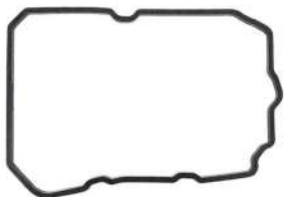

Immagini non in scala

Altri riferimenti:

724.2

N. Rapporti	7
-------------	---

N. Fori Guarnizione	-
---------------------	---

Note o Discriminanti:

-

Intervallo di manutenzione:

50000 / 3 ANNI

Composizione del kit:

Filtro + Guarnizione in gomma

Acquisto consigliato insieme a:

-

Alternative al prodotto:

-

AB6086AT

MB 9G-TRONIC



x10

Immagini non in scala

Altri riferimenti:

725.0

N. Rapporti	9
-------------	---

N. Fori Guarnizione	-
---------------------	---

Note o Discriminanti:

-

Intervallo di manutenzione:

60000 / 4 ANNI

Composizione del kit:

Coppa con guarnizione installata + Viti torx (x10)

Acquisto consigliato insieme a:

-

Alternative al prodotto:

-

AB6087AT

MB 9G-TRONIC



x10

Immagini non in scala

Altri riferimenti:

725.0

N. Rapporti	9
-------------	---

N. Fori Guarnizione	-
---------------------	---

Note o Discriminanti:

Per versioni Hybrid

Intervallo di manutenzione:

60000 / 4 ANNI

Composizione del kit:

Coppa con guarnizione installata + Viti torx (x10)

Acquisto consigliato insieme a:

-

Alternative al prodotto:

-

AB6088AT

MB 9G-TRONIC
JATCO JR913E

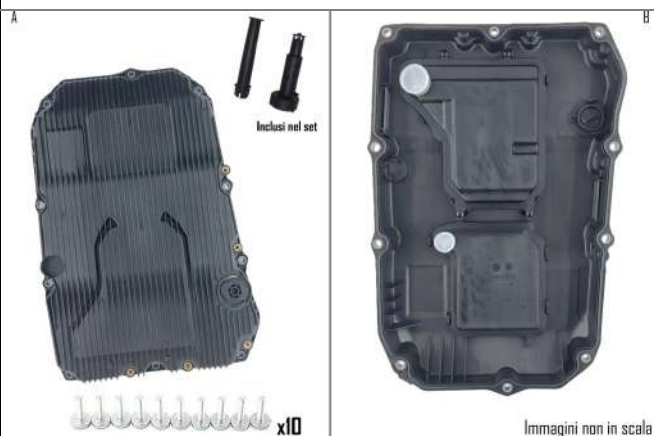

Altri riferimenti:

725.0

N. Rapporti	9
-------------	---

N. Fori Guarnizione	-
---------------------	---

Note o Discriminanti:

-

Intervallo di manutenzione:

60000 / 4 ANNI

Composizione del kit:

Completo filtro con OR installati + 2 Tubi olio + Viti torx (x10)

Acquisto consigliato insieme a:

-

Alternative al prodotto:

-

AB6089AT

MB FTC Siemens



Altri riferimenti:

722.7

N. Rapporti	5
-------------	---

N. Fori Guarnizione	-
---------------------	---

Note o Discriminanti:

-

Intervallo di manutenzione:

60000 / 4 ANNI

Composizione del kit:

Filtro + Guarnizione in gomma

Acquisto consigliato insieme a:

-

Alternative al prodotto:

-

AB6090AT

MB Temic VGS



Altri riferimenti:

722.8

N. Rapporti	CVT
-------------	-----

N. Fori Guarnizione	-
---------------------	---

Note o Discriminanti:

-

Intervallo di manutenzione:

50000 / 3 ANNI

Composizione del kit:

Filtro + Guarnizione in gomma

Acquisto consigliato insieme a:

-

Alternative al prodotto:

AB6091AT

AB6091AT

MB Temic VGS



Altri riferimenti:

722.8

N. Rapporti	CVT
N. Fori Guarnizione	8

Note o Discriminanti:

-

Intervallo di manutenzione:

50000 / 3 ANNI

Composizione del kit:

Filtro + Guarnizione in metallo

Acquisto consigliato insieme a:

-

Alternative al prodotto:

AB6090AT

AB6092AT

MITSUBISHI F4A51, F5A51



Altri riferimenti:

-

N. Rapporti	4 / 5
N. Fori Guarnizione	15

Note o Discriminanti:

-

Intervallo di manutenzione:

80000 / 4 ANNI

Composizione del kit:

Filtro + Guarnizione in gomma

Acquisto consigliato insieme a:

-

Alternative al prodotto:

-

AB6093AT

MITSUBISHI R4A51, V4A51
MITSUBISHI R5A51, V5A51



Altri riferimenti:

V73

N. Rapporti	4
N. Fori Guarnizione	20

Note o Discriminanti:

Pescante basso

Intervallo di manutenzione:

60000 / 4 ANNI

Composizione del kit:

Filtro + Guarnizione in gomma

Acquisto consigliato insieme a:

-

Alternative al prodotto:

-

AB6094AT

MITSUBISHI R4A51, V4A51
MITSUBISHI R5A51, V5A51



Immagini non in scala

Altri riferimenti:

V75

N. Rapporti	4
N. Fori Guarnizione	20

Note o Discriminanti:

Pescante h.12mm

Intervallo di manutenzione:

60000 / 4 ANNI

Composizione del kit:

Filtro + Guarnizione in gomma

Acquisto consigliato insieme a:

-

Alternative al prodotto:

-

AB6095AT

MULTITRONIC



Immagini non in scala

Altri riferimenti:

OAW

N. Rapporti	CVT 8
N. Fori Guarnizione	-

Note o Discriminanti:

-

Intervallo di manutenzione:

60000 / 4 ANNI

Composizione del kit:

Cartuccia + O' Ring

Acquisto consigliato insieme a:

AB6097AT

Alternative al prodotto:

AB6096AT

AB6096AT

MULTITRONIC



Immagini non in scala

Altri riferimenti:

OAW

N. Rapporti	CVT 8
N. Fori Guarnizione	-

Note o Discriminanti:

-

Intervallo di manutenzione:

60000 / 4 ANNI

Composizione del kit:

Completo filtro premontato

Acquisto consigliato insieme a:

AB6097AT

Alternative al prodotto:

AB6095AT

AB6097AT

MULTITRONIC



Altri riferimenti:

OAW

N. Rapporti

CVT

N. Fori Guarnizione

12 e 21

Note o Discriminanti:

Filtro interno

Intervallo di manutenzione:

60000 / 4 ANNI

Composizione del kit:

Filtro + Guarnizione carta x2

Acquisto consigliato insieme a:

AB6095AT

Alternative al prodotto:

-

AB6098AT

POWERSHIFT DCT450 , DCT470



Altri riferimenti:

DCS6 ,SPS6, MPS6

N. Rapporti

6

N. Fori Guarnizione

-

Note o Discriminanti:

Filtro esterno

Intervallo di manutenzione:

60000 / 4 ANNI

Composizione del kit:

Cartuccia + O' Ring

Acquisto consigliato insieme a:

AB6100AT

Alternative al prodotto:

AB6099AT

AB6099AT

POWERSHIFT DCT450 , DCT470



Altri riferimenti:

DCS6 ,SPS6, MPS6

N. Rapporti

6

N. Fori Guarnizione

-

Note o Discriminanti:

Filtro esterno

Intervallo di manutenzione:

60000 / 4 ANNI

Composizione del kit:

Cartuccia + O' Ring + Calotta

Acquisto consigliato insieme a:

AB6100AT

Alternative al prodotto:

AB6098AT

AB6100AT

POWERSHIFT DCT450 , DCT470



Immagini non in scala

Altri riferimenti:

DCS6 ,SPS6, MPS6

N. Rapporti	6
N. Fori Guarnizione	-

Note o Discriminanti:

Filtro interno

Intervallo di manutenzione:

60000 / 4 ANNI

Composizione del kit:

Filtro + Guarnizione in gomma

Acquisto consigliato insieme a:

AB6098AT o AB6099AT

Alternative al prodotto:

-

AB6101AT

RENAULT DPO AL4



Immagini non in scala

Altri riferimenti:

-

N. Rapporti	4
N. Fori Guarnizione	-

Note o Discriminanti:

-

Intervallo di manutenzione:

80000 / 4 ANNI

Composizione del kit:

Filtro + Guarnizione in gomma

Acquisto consigliato insieme a:

-

Alternative al prodotto:

-

AB6102AT

S-TRONIC DL382

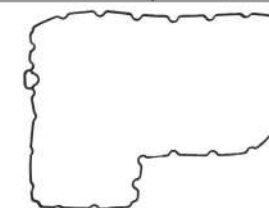

Immagini non in scala

Altri riferimenti:

OCL, OCK, OCL

N. Rapporti	7
N. Fori Guarnizione	-

Note o Discriminanti:

Filtro interno

Intervallo di manutenzione:

60000 / 4 ANNI

Composizione del kit:

Filtro + Guarnizione in gomma

Acquisto consigliato insieme a:

AB6103AT + AB6105AT

Alternative al prodotto:

-

AB6103AT

S-TRONIC DL382



Immagini non in scala

Altri riferimenti:

OCL, OCK, OCL

N. Rapporti	7
N. Fori Guarnizione	-

Note o Discriminanti:

Filtro esterno

Intervallo di manutenzione:

60000 / 4 ANNI

Composizione del kit:

Cartuccia + O' Ring

Acquisto consigliato insieme a:

AB6102AT + AT6105AT

Alternative al prodotto:

AB6104AT

AB6104AT

S-TRONIC DL382



Immagini non in scala

Altri riferimenti:

OCL, OCK, OCL

N. Rapporti	7
N. Fori Guarnizione	-

Note o Discriminanti:

Filtro esterno

Intervallo di manutenzione:

60000 / 4 ANNI

Composizione del kit:

Cartuccia + O' Ring + Calotta

Acquisto consigliato insieme a:

-

Alternative al prodotto:

AB6103AT

AB6105AT

S-TRONIC DL382



Immagini non in scala

Altri riferimenti:

OCL, OCK, OCL

N. Rapporti	7
N. Fori Guarnizione	-

Note o Discriminanti:

Filtro esterno

Intervallo di manutenzione:

60000 / 4 ANNI

Composizione del kit:

Cartuccia + O' Ring

Acquisto consigliato insieme a:

AB6102AT + AB6103AT

Alternative al prodotto:

AB6106AT

AB6106AT

S-TRONIC DL382



Altri riferimenti:

OCJ, OCK, OCL

N. Rapporti	7
-------------	---

N. Fori Guarnizione	-
---------------------	---

Note o Discriminanti:

Filtro esterno

Intervallo di manutenzione:

60000 / 4 ANNI

Composizione del kit:

Cartuccia + O' Ring + Calotta

Acquisto consigliato insieme a:

AB6105AT

Alternative al prodotto:

-

AB6107AT

S-TRONIC DL501



Altri riferimenti:

OB5

N. Rapporti	7
-------------	---

N. Fori Guarnizione	15
---------------------	----

Note o Discriminanti:

Filtro interno

Intervallo di manutenzione:

60000 / 4 ANNI

Composizione del kit:

Filtro + Guarnizione in metallo

Acquisto consigliato insieme a:

AB6108AT

Alternative al prodotto:

-

AB6108AT

S-TRONIC DL501



Altri riferimenti:

OB5

N. Rapporti	7
-------------	---

N. Fori Guarnizione	-
---------------------	---

Note o Discriminanti:

Filtro esterno

Intervallo di manutenzione:

60000 / 4 ANNI

Composizione del kit:

Cartuccia + O' Ring

Acquisto consigliato insieme a:

AB6107AT

Alternative al prodotto:

AB6109AT o AB6110AT

AB6109AT

S-TRONIC DL501



Altri riferimenti:

OB5

N. Rapporti 7

N. Fori Guarnizione -

Note o Discriminanti:

Filtro esterno

Intervallo di manutenzione:

60000 / 4 ANNI

Composizione del kit:

Cartuccia + O' Ring + Calotta

Acquisto consigliato insieme a:

AB6107AT

Alternative al prodotto:

AB6108AT o AB6110AT

AB6110AT

S-TRONIC DL501



Altri riferimenti:

OB5

N. Rapporti 7

N. Fori Guarnizione -

Note o Discriminanti:

Filtro esterno

Intervallo di manutenzione:

60000 / 4 ANNI

Composizione del kit:

Completo filtro premontato

Acquisto consigliato insieme a:

AB6107AT

Alternative al prodotto:

AB6108AT o AB6110AT

AB6111AT

SUBARU LINEATRONIC



Altri riferimenti:

TR580, TR690

N. Rapporti CVT

N. Fori Guarnizione -

Note o Discriminanti:

Filtro esterno

Intervallo di manutenzione:

80000 / 4 ANNI

Composizione del kit:

Cartuccia

Acquisto consigliato insieme a:

AB6112AT + AB6113AT / AB6112AT + AB6114AT

Alternative al prodotto:

-

AB6112AT

SUBARU LINEATRONIC



Altri riferimenti:

TR580

N. Rapporti

CVT

N. Fori Guarnizione

12

Note o Discriminanti:

Filtro interno, versione a trapezio

Intervallo di manutenzione:

80000 / 4 ANNI

Composizione del kit:

Filtro + Guarnizione in gomma

Acquisto consigliato insieme a:

AB6111AT + AB6113AT / AB6111AT + AB6114AT

Alternative al prodotto:

-

AB6113AT

SUBARU LINEATRONIC



Altri riferimenti:

TR580

N. Rapporti

CVT

N. Fori Guarnizione

12

Note o Discriminanti:

Filtro interno, versione quadrata

Intervallo di manutenzione:

80000 / 4 ANNI

Composizione del kit:

Filtro + Guarnizione in gomma

Acquisto consigliato insieme a:

AB6111AT + AB6112AT

Alternative al prodotto:

AB6114AT

AB6114AT

SUBARU LINEATRONIC

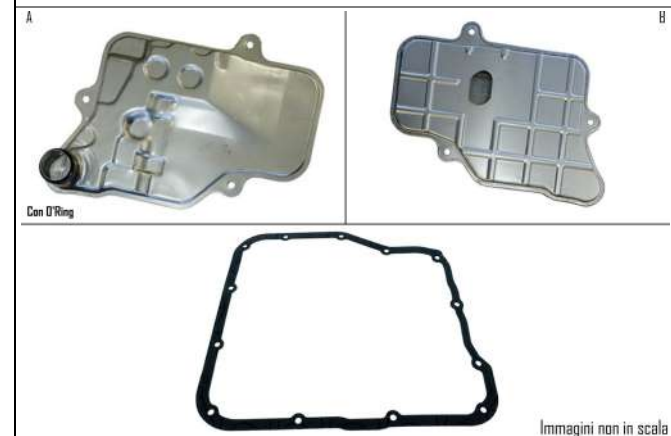

Altri riferimenti:

TR690

N. Rapporti

CVT

N. Fori Guarnizione

13

Note o Discriminanti:

Filtro interno

Intervallo di manutenzione:

80000 / 4 ANNI

Composizione del kit:

Filtro + Guarnizione in gomma

Acquisto consigliato insieme a:

AB6111AT + AB6112AT

Alternative al prodotto:

AB6113AT

AB6115AT

SUBARU R4AX-EL



Immagini non in scala

Altri riferimenti:

-

N. Rapporti	4
-------------	---

N. Fori Guarnizione	20
---------------------	----

Note o Discriminanti:

-

Intervallo di manutenzione:

80000 / 4 ANNI

Composizione del kit:

Filtro + Guarnizione in gomma

Acquisto consigliato insieme a:

AB6116AT

Alternative al prodotto:

-

AB6116AT

SUBARU R4AX-EL



Immagini non in scala

Altri riferimenti:

-

N. Rapporti	4
-------------	---

N. Fori Guarnizione	-
---------------------	---

Note o Discriminanti:

-

Intervallo di manutenzione:

80000 / 4 ANNI

Composizione del kit:

Filtro olio spin on

Acquisto consigliato insieme a:

AB6115AT

Alternative al prodotto:

-

AB6117AT

SUZUKI TW-40LS

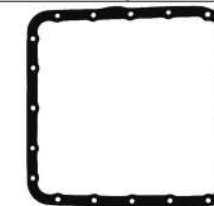

Immagini non in scala

Altri riferimenti:

-

N. Rapporti	4
-------------	---

N. Fori Guarnizione	19
---------------------	----

Note o Discriminanti:

-

Intervallo di manutenzione:

80000 / 4 ANNI

Composizione del kit:

Filtro + Guarnizione in gomma

Acquisto consigliato insieme a:

-

Alternative al prodotto:

-

AB6118AT

TESLA



Immagini non in scala

Altri riferimenti:

-

N. Rapporti

-

N. Fori Guarnizione

-

Note o Discriminanti:

Filtro Interno

Intervallo di manutenzione:

80000 / 4 ANNI

Composizione del kit:

Cartuccia + O' Ring

Acquisto consigliato insieme a:

-

Alternative al prodotto:

-

AB6119AT

TESLA



lpz

Immagini non in scala

Altri riferimenti:

-

N. Rapporti

-

N. Fori Guarnizione

-

Note o Discriminanti:

-

Intervallo di manutenzione:

80000 / 4 ANNI

Composizione del kit:

Filtro olio spin on

Acquisto consigliato insieme a:

-

Alternative al prodotto:

-

AB6120AT

TOYOTA A340H AW4



Immagini non in scala

Altri riferimenti:

-

N. Rapporti

4

N. Fori Guarnizione

19

Note o Discriminanti:

Veicoli dotati di 4x4

Intervallo di manutenzione:

80000 / 4 ANNI

Composizione del kit:

Filtro + Guarnizione in gomma

Acquisto consigliato insieme a:

-

Alternative al prodotto:

-

AB6121AT

TOYOTA A442F



Immagini non in scala

Altri riferimenti:

-

N. Rapporti 4

N. Fori Guarnizione 20

Note o Discriminanti:

A doppio ingresso -Per applicazioni dal 1995

Intervallo di manutenzione:

80000 / 4 ANNI

Composizione del kit:

Filtro + Guarnizione in gomma

Acquisto consigliato insieme a:

-

Alternative al prodotto:

-

AB6122AT

TOYOTA A750E, A750F

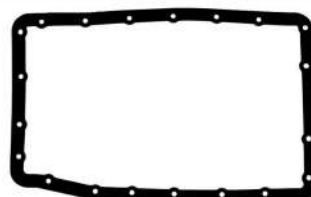

Immagini non in scala

Altri riferimenti:

-

N. Rapporti 5

N. Fori Guarnizione 20

Note o Discriminanti:

-

Intervallo di manutenzione:

80000 / 4 ANNI

Composizione del kit:

Filtro + Guarnizione in gomma

Acquisto consigliato insieme a:

-

Alternative al prodotto:

-

AB6123AT

TOYOTA A760E, A760H, A761E, A761H, A960E



Immagini non in scala

Altri riferimenti:

-

N. Rapporti 6

N. Fori Guarnizione 12

Note o Discriminanti:

-

Intervallo di manutenzione:

80000 / 4 ANNI

Composizione del kit:

Filtro + Guarnizione in gomma + Boccole (x12)

Acquisto consigliato insieme a:

-

Alternative al prodotto:

-

AB6124AT

TOYOTA K114, K115



Immagini non in scala

Altri riferimenti:

-

N. Rapporti

CVT

N. Fori Guarnizione

19

Note o Discriminanti:

-

Intervallo di manutenzione:

80000 / 4 ANNI

Composizione del kit:

Filtro + Guarnizione in gomma

Acquisto consigliato insieme a:

-

Alternative al prodotto:

-

AB6125AT

TOYOTA K120

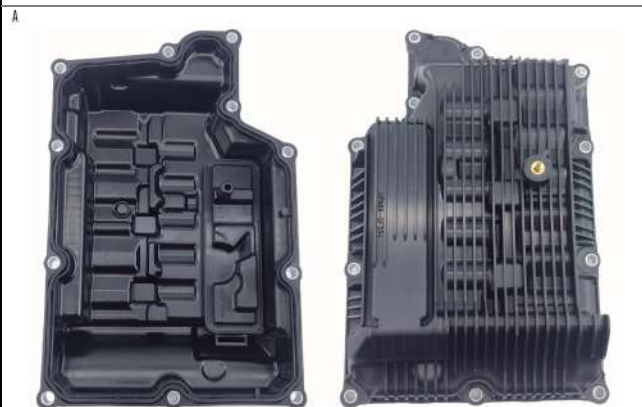

Altri riferimenti:

-

N. Rapporti

CVT

N. Fori Guarnizione

-

Note o Discriminanti:

Filtro esterno

Intervallo di manutenzione:

80000 / 4 ANNI

Composizione del kit:

Coppa con guarnizione preinstallata

Acquisto consigliato insieme a:

AB6126AT

Alternative al prodotto:

-

AB6126AT

TOYOTA K120



Immagini non in scala

Altri riferimenti:

-

N. Rapporti

CVT

N. Fori Guarnizione

22

Note o Discriminanti:

Filtro interno

Intervallo di manutenzione:

80000 / 4 ANNI

Composizione del kit:

Filtro + Guarnizione in gomma

Acquisto consigliato insieme a:

AB6125AT

Alternative al prodotto:

-

AB6127AT

TOYOTA K310, K311



Immagini non in scala

Altri riferimenti:

-

N. Rapporti

CVT

N. Fori Guarnizione

-

Note o Discriminanti:

-

Intervallo di manutenzione:

80000 / 4 ANNI

Composizione del kit:

Cartuccia

Acquisto consigliato insieme a:

AB6128AT o AB6129AT

Alternative al prodotto:

-

AB6128AT

TOYOTA K310

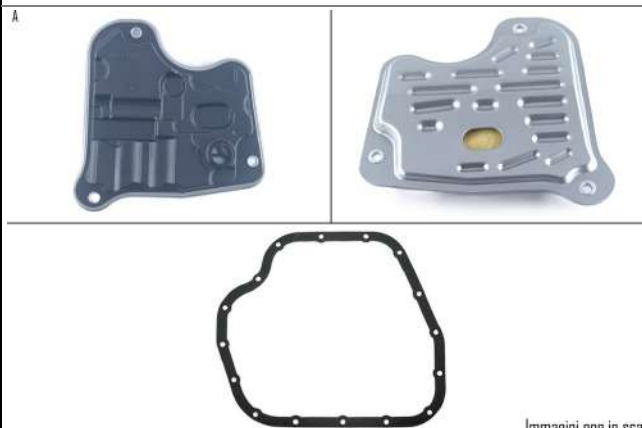

Immagini non in scala

Altri riferimenti:

-

N. Rapporti

CVT

N. Fori Guarnizione

16

Note o Discriminanti:

Pescante basso

Intervallo di manutenzione:

80000 / 4 ANNI

Composizione del kit:

Filtro + Guarnizione in gomma

Acquisto consigliato insieme a:

AB6127AT

Alternative al prodotto:

AB6129AT

AB6129AT

TOYOTA K311



Immagini non in scala

Altri riferimenti:

-

N. Rapporti

CVT

N. Fori Guarnizione

16

Note o Discriminanti:

Pescante alto

Intervallo di manutenzione:

80000 / 4 ANNI

Composizione del kit:

Filtro + Guarnizione in gomma

Acquisto consigliato insieme a:

AB6127AT

Alternative al prodotto:

AB6128AT

AB6130AT

TOYOTA K313



Immagini non in scala

Altri riferimenti:

-

N. Rapporti	CVT
N. Fori Guarnizione	16

Note o Discriminanti:

Pescante tagliato

Intervallo di manutenzione:

80000 / 4 ANNI

Composizione del kit:

Filtro + Guarnizione in gomma

Acquisto consigliato insieme a:

-

Alternative al prodotto:

-

AB6131AT

TOYOTA U660E, U660F, U760E



Immagini non in scala

Altri riferimenti:

-

N. Rapporti	6
N. Fori Guarnizione	18

Note o Discriminanti:

-

Intervallo di manutenzione:

80000 / 4 ANNI

Composizione del kit:

Filtro + Guarnizione in gomma

Acquisto consigliato insieme a:

-

Alternative al prodotto:

-

AB6132AT

VW AG4



Immagini non in scala

Altri riferimenti:

096

N. Rapporti	4
N. Fori Guarnizione	4

Note o Discriminanti:

Per OE: 096321370

Intervallo di manutenzione:

80000 / 4 ANNI

Composizione del kit:

Filtro + Guarnizione gomma (boccole x4)

Acquisto consigliato insieme a:

-

Alternative al prodotto:

-

AB6133AT

VW AG4



Immagini non in scala

Altri riferimenti:

097

N. Rapporti	4
-------------	---

N. Fori Guarnizione	5
---------------------	---

Note o Discriminanti:

Per OE: 097321370

Intervallo di manutenzione:

80000 / 4 ANNI

Composizione del kit:

Filtro + Guarnizione in gomma + Boccole (x5)

Acquisto consigliato insieme a:

-

Alternative al prodotto:

-

AB6134AT

VW AG4



Immagini non in scala

Altri riferimenti:

01M

N. Rapporti	4
-------------	---

N. Fori Guarnizione	4
---------------------	---

Note o Discriminanti:

Per OE: 095321371

Intervallo di manutenzione:

80000 / 4 ANNI

Composizione del kit:

Filtro + Guarnizione gomma + Boccole (x4)

Acquisto consigliato insieme a:

-

Alternative al prodotto:

-

AB6135AT

VW AG4



Immagini non in scala

Altri riferimenti:

01N

N. Rapporti	4
-------------	---

N. Fori Guarnizione	5
---------------------	---

Note o Discriminanti:

Per OE: 01N321371

Intervallo di manutenzione:

80000 / 4 ANNI

Composizione del kit:

Filtro + Guarnizione in gomma + Boccole (x5)

Acquisto consigliato insieme a:

-

Alternative al prodotto:

-

AB6136AT

VW AISIN TF60SN/61



Immagini non in scala

Altri riferimenti:

09G, 09K, 09M, AQ250

N. Rapporti	6
-------------	---

N. Fori Guarnizione	8
---------------------	---

Note o Discriminanti:

Pescante basso

Intervallo di manutenzione:

60000 / 4 ANNI

Composizione del kit:

Filtro + Guarnizione gomma + Boccole (x8)

Acquisto consigliato insieme a:

-

Alternative al prodotto:

-

AB6137AT

VW AISIN TF60SN/61



Immagini non in scala

Altri riferimenti:

09G, 09K, 09M, AQ250

N. Rapporti	6
-------------	---

N. Fori Guarnizione	8
---------------------	---

Note o Discriminanti:

Pescante h.4mm

Intervallo di manutenzione:

60000 / 4 ANNI

Composizione del kit:

Filtro + Guarnizione in gomma + Boccole (x8)

Acquisto consigliato insieme a:

-

Alternative al prodotto:

-

AB6138AT

VW AISIN TF64SN



Immagini non in scala

Altri riferimenti:

AQ250, 09G

N. Rapporti	6
-------------	---

N. Fori Guarnizione	8
---------------------	---

Note o Discriminanti:

Pescante basso

Intervallo di manutenzione:

80000 / 4 ANNI

Composizione del kit:

Filtro + Guarnizione in gomma + Boccole (x8) + OR

Acquisto consigliato insieme a:

-

Alternative al prodotto:

AB6139AT

AB6139AT

VW AISIN TF64SN



Altri riferimenti:

AQ250, 09G

N. Rapporti	6
N. Fori Guarnizione	8

Note o Discriminanti:

Pescante h.10mm

Intervallo di manutenzione:

80000 / 4 ANNI

Composizione del kit:

Filtro + Guarnizione in gomma + Boccole (x8) + OR

Acquisto consigliato insieme a:

-

Alternative al prodotto:

AB6138AT

AB6140AT

VW AQ450



Altri riferimenti:

09Q

N. Rapporti	8
N. Fori Guarnizione	9

Note o Discriminanti:

-

Intervallo di manutenzione:

80000 / 4 ANNI

Composizione del kit:

Filtro + Guarnizione in gomma + OR + Boccole (x9)

Acquisto consigliato insieme a:

-

Alternative al prodotto:

-

AB6141AT

ZF 4HP18



Altri riferimenti:

-

N. Rapporti	4
N. Fori Guarnizione	-

Note o Discriminanti:

-

Intervallo di manutenzione:

80000 / 4 ANNI

Composizione del kit:

Filtro + Guarnizione in gomma

Acquisto consigliato insieme a:

AB6142AT

Alternative al prodotto:

-

AB6142AT

ZF 4HP18



Immagini non in scala

Altri riferimenti:

-

N. Rapporti

4

N. Fori Guarnizione

-

Note o Discriminanti:

Non per applicazioni AUDI

Intervallo di manutenzione:

80000 / 4 ANNI

Composizione del kit:

Cartuccia + O' Ring

Acquisto consigliato insieme a:

AB6141AT

Alternative al prodotto:

-

AB6143AT

ZF 4HP20



Immagini non in scala

Altri riferimenti:

-

N. Rapporti

4

N. Fori Guarnizione

-

Note o Discriminanti:

-

Intervallo di manutenzione:

80000 / 4 ANNI

Composizione del kit:

Filtro + Guarnizione in gomma

Acquisto consigliato insieme a:

-

Alternative al prodotto:

-

AB6144AT

ZF 4HP22, 4HP24



Immagini non in scala

Altri riferimenti:

-

N. Rapporti

4

N. Fori Guarnizione

-

Note o Discriminanti:

Senza beccuccio - Per BMW

Intervallo di manutenzione:

80000 / 4 ANNI

Composizione del kit:

Filtro + Guarnizione in gomma

Acquisto consigliato insieme a:

-

Alternative al prodotto:

AB6145AT

AB6145AT

ZF 4HP22, 4HP24



Altri riferimenti:

-

N. Rapporti

4

N. Fori Guarnizione

-

Note o Discriminanti:

Con beccuccio - Per BMW

Intervallo di manutenzione:

80000 / 4 ANNI

Composizione del kit:

Filtro + Guarnizione in gomma

Acquisto consigliato insieme a:

-

Alternative al prodotto:

AB6144AT

AB6146AT

ZF 4HP22, 4HP24



Altri riferimenti:

-

N. Rapporti

4

N. Fori Guarnizione

-

Note o Discriminanti:

Con beccuccio - Per L. ROVER

Intervallo di manutenzione:

80000 / 4 ANNI

Composizione del kit:

Filtro + Guarnizione in gomma

Acquisto consigliato insieme a:

-

Alternative al prodotto:

-

AB6147AT

ZF 4HP24A



Altri riferimenti:

-

N. Rapporti

4

N. Fori Guarnizione

-

Note o Discriminanti:

-

Intervallo di manutenzione:

80000 / 4 ANNI

Composizione del kit:

Filtro + Guarnizione in gomma

Acquisto consigliato insieme a:

-

Alternative al prodotto:

-

AB6148AT

ZF 5HP18



Immagini non in scala

Altri riferimenti:

A5S 310Z

N. Rapporti	5
N. Fori Guarnizione	-

Note o Discriminanti:

-

Intervallo di manutenzione:

80000 / 4 ANNI

Composizione del kit:

Filtro + Guarnizione in gomma

Acquisto consigliato insieme a:

-

Alternative al prodotto:

-

AB6149AT

ZF 5HP19 01V

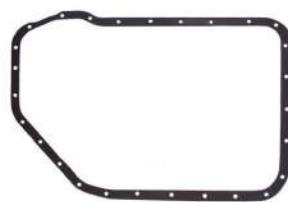

Immagini non in scala

Altri riferimenti:

FL, FLA, A5S335Z

N. Rapporti	5
N. Fori Guarnizione	27

Note o Discriminanti:

Per applicazioni AUDI

Intervallo di manutenzione:

80000 / 4 ANNI

Composizione del kit:

Filtro + Guarnizione in gomma

Acquisto consigliato insieme a:

-

Alternative al prodotto:

-

AB6150AT

ZF 5HP19

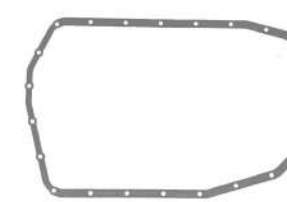

Immagini non in scala

Altri riferimenti:

A5S 325Z

N. Rapporti	5
N. Fori Guarnizione	22

Note o Discriminanti:

Per applicazioni BMW

Intervallo di manutenzione:

80000 / 4 ANNI

Composizione del kit:

Filtro + Guarnizione in gomma

Acquisto consigliato insieme a:

-

Alternative al prodotto:

-

AB6151AT

ZF 5HP24



Immagini non in scala

Altri riferimenti:

A5S 440Z

N. Rapporti	5
N. Fori Guarnizione	22

Note o Discriminanti:

-

Intervallo di manutenzione:

80000 / 4 ANNI

Composizione del kit:

Filtro + Guarnizione in gomma

Acquisto consigliato insieme a:

-

Alternative al prodotto:

-

AB6152AT

ZF 6HP19

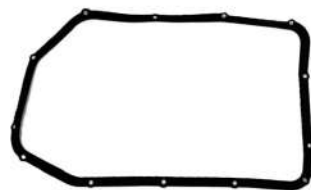

Immagini non in scala

Altri riferimenti:

OAT

N. Rapporti	6
N. Fori Guarnizione	13

Note o Discriminanti:

Tubo OUT h.96mm e pescante alto

Intervallo di manutenzione:

80000 / 4 ANNI

Composizione del kit:

Filtro + Guarnizione in gomma

Acquisto consigliato insieme a:

-

Alternative al prodotto:

AB6153AT

AB6153AT

ZF 6HP19



Immagini non in scala

Altri riferimenti:

OAT

N. Rapporti	6
N. Fori Guarnizione	13 + 6

Note o Discriminanti:

Tubo OUT h.96mm e pescante alto

Intervallo di manutenzione:

80000 / 4 ANNI

Composizione del kit:

Filtro + Guarnizione in metallo

Acquisto consigliato insieme a:

-

Alternative al prodotto:

AB6152AT

AB6154AT

ZF 6HP19A



Immagini non in scala

Altri riferimenti:

09L

N. Rapporti 6

N. Fori Guarnizione 13

Note o Discriminanti:

Veicoli dotati di 4x4
Tubo OUT h.142mm e pescante basso

Intervallo di manutenzione:

80000 / 4 ANNI

Composizione del kit:

Filtro + Guarnizione in gomma

Acquisto consigliato insieme a:

-

Alternative al prodotto:

AB6155AT

AB6155AT

ZF 6HP19A



Immagini non in scala

Altri riferimenti:

09L

N. Rapporti 6

N. Fori Guarnizione 13 + 6

Note o Discriminanti:

Veicoli dotati di 4x4
Tubo OUT h.142mm e pescante basso

Intervallo di manutenzione:

80000 / 4 ANNI

Composizione del kit:

Filtro + Guarnizione in metallo

Acquisto consigliato insieme a:

-

Alternative al prodotto:

AB6154AT

AB6156AT

ZF 6HP26, 6HP32



Immagini non in scala

Altri riferimenti:

R60, R75, R80

N. Rapporti 6

N. Fori Guarnizione 21

Note o Discriminanti:

Tubo OUT h.97mm

Intervallo di manutenzione:

80000 / 4 ANNI

Composizione del kit:

Filtro + Guarnizione in gomma

Acquisto consigliato insieme a:

-

Alternative al prodotto:

AB6157AT

AB6157AT

ZF 6HP26, 6HP32



Immagini non in scala

Altri riferimenti:

R60, R75, R80

N. Rapporti	6
N. Fori Guarnizione	21

Note o Discriminanti:

Tubo OUT h.97mm

Intervallo di manutenzione:

80000 / 4 ANNI

Composizione del kit:

Filtro + Guarnizione in metallo

Acquisto consigliato insieme a:

-

Alternative al prodotto:

AB6156AT

AB6158AT

ZF 6HP26



Immagini non in scala

Altri riferimenti:

09E

N. Rapporti	6
N. Fori Guarnizione	13

Note o Discriminanti:

Tubo OUT h.113mm e pescante stretto

Intervallo di manutenzione:

80000 / 4 ANNI

Composizione del kit:

Filtro + Guarnizione in gomma

Acquisto consigliato insieme a:

-

Alternative al prodotto:

AB6159AT

AB6159AT

ZF 6HP26



Immagini non in scala

Altri riferimenti:

09E

N. Rapporti	6
N. Fori Guarnizione	13 + 6

Note o Discriminanti:

Tubo OUT h.113mm e pescante stretto

Intervallo di manutenzione:

80000 / 4 ANNI

Composizione del kit:

Filtro + Guarnizione in metallo

Acquisto consigliato insieme a:

-

Alternative al prodotto:

AB6158AT

AB6160AT

ZF 6HP26A, 6HP28AF



Immagini non in scala

Altri riferimenti:

OB6

N. Rapporti	6
N. Fori Guarnizione	13

Note o Discriminanti:

Tubo OUT h.113mm e pescante largo

Intervallo di manutenzione:

80000 / 4 ANNI

Composizione del kit:

Filtro + Guarnizione in gomma

Acquisto consigliato insieme a:

-

Alternative al prodotto:

AB6161AT

AB6161AT

ZF 6HP26A, 6HP28AF



Immagini non in scala

Altri riferimenti:

OB6

N. Rapporti	6
N. Fori Guarnizione	13 + 6

Note o Discriminanti:

Tubo OUT h.113mm e pescante largo

Intervallo di manutenzione:

80000 / 4 ANNI

Composizione del kit:

Filtro + Guarnizione in metallo

Acquisto consigliato insieme a:

-

Alternative al prodotto:

AB6160AT

AB6162AT

ZH 6HP19X, 6HP19Z, 6HP21X



Immagini non in scala

Altri riferimenti:

-

N. Rapporti	6
N. Fori Guarnizione	-

Note o Discriminanti:

-

Intervallo di manutenzione:

80000 / 4 ANNI

Composizione del kit:

Coppa con guarnizione installata + Viti torx (x24)

Acquisto consigliato insieme a:

-

Alternative al prodotto:

-

AB6163AT

ZF 6HP26Z



Altri riferimenti:

GA6HP26Z

N. Rapporti	6
N. Fori Guarnizione	-

Note o Discriminanti:

-

Intervallo di manutenzione:

80000 / 4 ANNI

Composizione del kit:

Coppa con guarnizione installata + Viti torx (x21)

Acquisto consigliato insieme a:

-

Alternative al prodotto:

-

AB6164AT

ZF 8HP45



Altri riferimenti:

AT8

N. Rapporti	8
N. Fori Guarnizione	-

Note o Discriminanti:

-

Intervallo di manutenzione:

60000 / 4 ANNI

Composizione del kit:

Coppa con guarnizione installata + Viti torx (x13)

Acquisto consigliato insieme a:

-

Alternative al prodotto:

-

AB6165AT

ZF 8HP45X

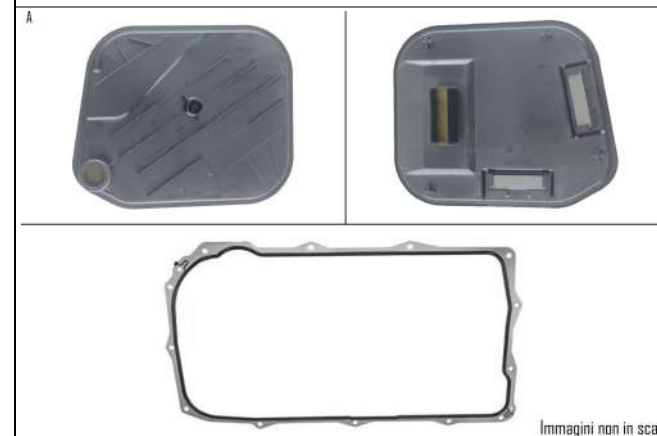

Altri riferimenti:

OCM, AL450

N. Rapporti	8
N. Fori Guarnizione	13 + 2 piccoli

Note o Discriminanti:

-

Intervallo di manutenzione:

80000 / 4 ANNI

Composizione del kit:

Filtro + Guarnizione in metallo

Acquisto consigliato insieme a:

-

Alternative al prodotto:

-

AB6166AT

ZF 8HP55, 8HP90A



Immagini non in scala

Altri riferimenti:

OBK, NVF, QD

N. Rapporti	8
N. Fori Guarnizione	12 + 3 piccoli

Note o Discriminanti:

-

Intervallo di manutenzione:

80000 / 4 ANNI

Composizione del kit:

Filtro + Guarnizione in metallo

Acquisto consigliato insieme a:

-

Alternative al prodotto:

-

AB6167AT

ZF 8HP55AH, 8HP55H



Immagini non in scala

Altri riferimenti:

OBL

N. Rapporti	8
N. Fori Guarnizione	12 + 3 piccoli

Note o Discriminanti:

-

Intervallo di manutenzione:

80000 / 4 ANNI

Composizione del kit:

Filtro + Guarnizione in metallo

Acquisto consigliato insieme a:

-

Alternative al prodotto:

-

AB6168AT

ZF 8HP65A



x12

Immagini non in scala

Altri riferimenti:

OD5

N. Rapporti	8
N. Fori Guarnizione	-

Note o Discriminanti:

-

Intervallo di manutenzione:

80000 / 4 ANNI

Composizione del kit:

Coppa con guarnizione installata + Viti torx (x12)

Acquisto consigliato insieme a:

-

Alternative al prodotto:

-

AB6169AT

ZF 8HP65A



Altri riferimenti:

OD7

N. Rapporti	8
N. Fori Guarnizione	-

Note o Discriminanti:

Per versioni Hybrid

Intervallo di manutenzione:

80000 / 4 ANNI

Composizione del kit:

Coppa con guarnizione installata + Viti torx (x12)

Acquisto consigliato insieme a:

-

Alternative al prodotto:

-

AB6170AT

ZF 8HP70



Altri riferimenti:

-

N. Rapporti	8
N. Fori Guarnizione	-

Note o Discriminanti:

-

Intervallo di manutenzione:

80000 / 4 ANNI

Composizione del kit:

Coppa con guarnizione installata + Viti torx (x13)

Acquisto consigliato insieme a:

-

Alternative al prodotto:

-

AB6171AT

ZF 8HP70H



Altri riferimenti:

-

N. Rapporti	8
N. Fori Guarnizione	-

Note o Discriminanti:

-

Intervallo di manutenzione:

80000 / 4 ANNI

Composizione del kit:

Coppa con guarnizione installata + Viti torx (x13)

Acquisto consigliato insieme a:

-

Alternative al prodotto:

-

AB6172AT

ZF 8HP75PH, 8HP75XPH



Altri riferimenti:

GA8P75HZ

N. Rapporti	8
N. Fori Guarnizione	-

Note o Discriminanti:

-

Intervallo di manutenzione:

50000 / 3 ANNI

Composizione del kit:

Coppa con guarnizione installata + Viti torx (x14)

Acquisto consigliato insieme a:

-

Alternative al prodotto:

-

AB6173AT

ZF 8HP75X, 8HP75, 8HP75HIS



Altri riferimenti:

-

N. Rapporti	8
N. Fori Guarnizione	15

Note o Discriminanti:

-

Intervallo di manutenzione:

80000 / 4 ANNI

Composizione del kit:

Filtro + Guarnizione in gomma

Acquisto consigliato insieme a:

-

Alternative al prodotto:

-

AB6174AT

ZT 8HP90



Altri riferimenti:

OD6

N. Rapporti	8
N. Fori Guarnizione	-

Note o Discriminanti:

-

Intervallo di manutenzione:

80000 / 4 ANNI

Composizione del kit:

Coppa con guarnizione installata + Viti torx (x13)

Acquisto consigliato insieme a:

-

Alternative al prodotto:

-

AB6175AT

ZF 8HP95



Altri riferimenti:

OD6

N. Rapporti	8
-------------	---

N. Fori Guarnizione	-
---------------------	---

Note o Discriminanti:

-

Intervallo di manutenzione:

80000 / 4 ANNI

Composizione del kit:

Coppa con guarnizione installata + Viti torx (x13)

Acquisto consigliato insieme a:

-

Alternative al prodotto:

-

AB6176AT

ZF 9HP48



Altri riferimenti:

948TE

N. Rapporti	9
-------------	---

N. Fori Guarnizione	-
---------------------	---

Note o Discriminanti:

-

Intervallo di manutenzione:

80000 / 4 ANNI

Composizione del kit:

Filtro + Guarnizione in gomma

Acquisto consigliato insieme a:

-

Alternative al prodotto:

-

AB6177AT

MB 7G-TRONIC

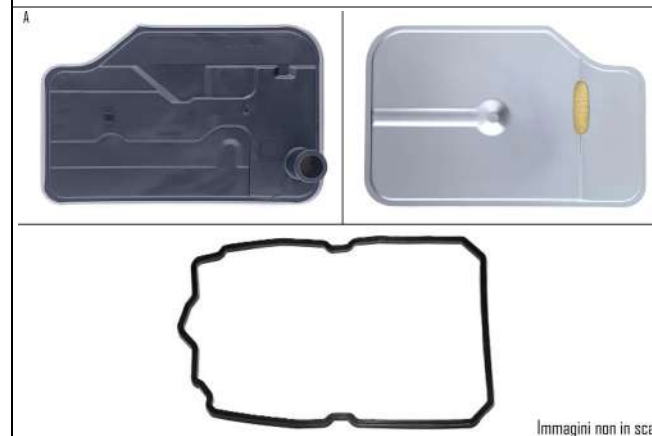

Altri riferimenti:

722.9

N. Rapporti	7
-------------	---

N. Fori Guarnizione	-
---------------------	---

Note o Discriminanti:

-

Intervallo di manutenzione:

50000 / 3 ANNI

Composizione del kit:

Filtro + Guarnizione in gomma

Acquisto consigliato insieme a:

-

Alternative al prodotto:

-

CORRISPONDENZE - FILTRI PER CAMBI AUTOMATICI

CROSS REFERENCE - AUTOMATIC TRANSMISSION FILTERS

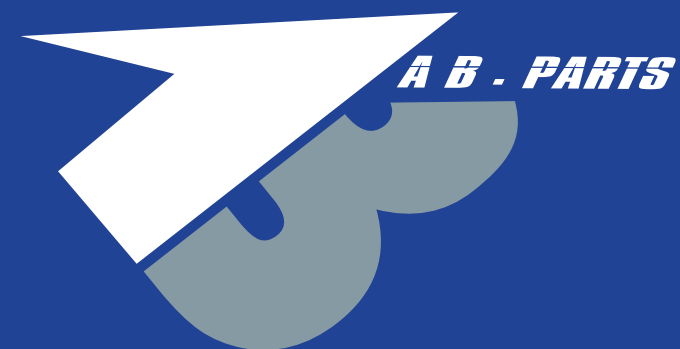



CATALOGO CROSS REFERENCE

AP XENERGY	X1570013	AB6153AT	ASHIKA	FTA058	AB6153AT	BENTLEY	OD6398359	AB6174AT	BMW - MINI	24117571227	AB6163AT
AP XENERGY	X1570061	AB6157AT	ASHIKA	FTA061	AB6032AT	BLUE PRINT	ADB112130	AB6157AT	BMW - MINI	24118632189	AB6172AT
AP XENERGY	X1570095	AB6099AT	ASHIKA	FTA064	AB6096AT	BLUE PRINT	ADBP210015	AB6084AT	BMW - MINI	24152285600	AB6148AT
AP XENERGY	X1578018	AB6157AT	ASHIKA	FTA078	AB6099AT	BLUE PRINT	ADBP210015	AB6083AT	BMW - MINI	24152333824	AB6046AT
AP XENERGY	X1578019	AB6157AT	ASHIKA	FTA098	AB6084AT	BLUE PRINT	ADBP210026	AB6099AT	BMW - MINI	24152333920	AB6148AT
AP XENERGY	X1578032	AB6084AT	ASHIKA	FTA098	AB6083AT	BLUE PRINT	ADBP210048	AB6159AT	BMW - MINI	24311218550	AB6144AT
AP XENERGY	X1578032	AB6083AT	ASHIKA	FTA161	AB6104AT	BLUE PRINT	ADBP210049	AB6159AT	BMW - MINI	24341215554	AB6144AT
AP XENERGY	X1578033	AB6084AT	ASHIKA	FTA161	AB6106AT	BLUE PRINT	ADBP210097	AB6153AT	BMW - MINI	24110403404	AB6163AT
AP XENERGY	X1578033	AB6083AT	AVS	TA0712K	AB6157AT	BLUE PRINT	ADBP210124	AB6104AT	BMW - MINI	24111423604	AB6047AT
AP XENERGY	X1578035	AB6084AT	AVS	TA0712KPLUS	AB6157AT	BLUE PRINT	ADBP210125	AB6106AT	BMW - MINI	24111423605	AB6047AT
AP XENERGY	X1578035	AB6083AT	AVS	TA1110K	AB6084AT	BLUE PRINT	ADBP210126	AB6104AT	BMW - MINI	24115A13115	AB6164AT
AP XENERGY	X1578055	AB6153AT	AVS	TA1110K	AB6083AT	BLUE PRINT	ADBP210126	AB6106AT	BMW - MINI	24115A13116	AB6164AT
AP XENERGY	X1578061	AB6032AT	AVS	TA1110KPLUS	AB6084AT	BLUE PRINT	ADF122123	AB6099AT	BMW - MINI	24117507643	AB6047AT
AP XENERGY	X1578064	AB6096AT	AVS	TA1110KPLUS	AB6083AT	BLUE PRINT	ADV182151	AB6153AT	BMW - MINI	24117510010	AB6047AT
ASHIKA	FTA018	AB6157AT	AVS	TA1315K	AB6159AT	BLUE PRINT	ADV182162	AB6159AT	BMW - MINI	2411751001251	AB6046AT
ASHIKA	FTA019	AB6157AT	AVS	TA1316K	AB6159AT	BLUE PRINT	ADV182166	AB6032AT	BMW - MINI	24117522923	AB6163AT
ASHIKA	FTA032	AB6084AT	AVS	TA1317K	AB6153AT	BLUE PRINT	ADV182170	AB6153AT	BMW - MINI	24117524707	AB6046AT
ASHIKA	FTA032	AB6083AT	AVS	TA1320K	AB6032AT	BLUE PRINT	ADV182179	AB6096AT	BMW - MINI	24117533657	AB6047AT
ASHIKA	FTA033	AB6084AT	AVS	TA1322	AB6096AT	BMW - MINI	24007855263	AB6173AT	BMW - MINI	24117533699	AB6046AT
ASHIKA	FTA033	AB6083AT	AVS	TA1337KPLUS	AB6104AT	BMW - MINI	24111218899	AB6043AT	BMW - MINI	2411753369951	AB6046AT
ASHIKA	FTA035	AB6084AT	AVS	TA1337KPLUS	AB6106AT	BMW - MINI	24117510011	AB6048AT	BMW - MINI	24117536387	AB6162AT
ASHIKA	FTA035	AB6083AT	AVS	TA4002K	AB6099AT	BMW - MINI	24117518741	AB6016AT	BMW - MINI	24117543550	AB6156AT
ASHIKA	FTA055	AB6153AT	BENTLEY	09E325429	AB6158AT	BMW - MINI	24117519359	AB6163AT	BMW - MINI	24117557070	AB6046AT
ASHIKA	FTA056	AB6159AT	BENTLEY	086325429	AB6160AT	BMW - MINI	24117557069	AB6048AT	BMW - MINI	24117557071	AB6047AT

BMW - MINI	24117571217	AB6162AT	BMW - MINI	28108070791	AB6014AT	CHEVROLET	24289324	AB6039AT	DACIA - RENAULT	317261XZ0A	AB6063AT
BMW - MINI	24117604960	AB6164AT	CADILLAC	747477	AB6043AT	CHEVROLET	24297793	AB6040AT	DACIA - RENAULT	3172628X0A	AB6064AT
BMW - MINI	24117624192	AB6164AT	CADILLAC	24230708	AB6052AT	CHEVROLET	96015432	AB6043AT	DACIA - RENAULT	317263JX0A	AB6064AT
BMW - MINI	24117631728	AB6171AT	CADILLAC	24237508	AB6051AT	CHEVROLET	24263302	AB6050AT	DACIA - RENAULT	317263XX0A	AB6064AT
BMW - MINI	24118632188	AB6171AT	CADILLAC	24246194	AB6052AT	CHEVROLET	24268086	AB6050AT	DACIA - RENAULT	317266A00A	AB6065AT
BMW - MINI	24152333899	AB6156AT	CADILLAC	24251353	AB6052AT	CHEVROLET	24290959	AB6054AT	DACIA - RENAULT	3172804X0B	AB6065AT
BMW - MINI	24152333903	AB6163AT	CADILLAC	24267569	AB6052AT	CHEVROLET	24292809	AB6053AT	DACIA - RENAULT	317281XA00	AB6062AT
BMW - MINI	24152333907	AB6162AT	CADILLAC	24268438	AB6040AT	CHEVROLET	3533080A010	AB6001AT	DACIA - RENAULT	317281XF02	AB6061AT
BMW - MINI	24152333915	AB6150AT	CADILLAC	24272927	AB6040AT	CHEVROLET	93741509	AB6001AT	DACIA - RENAULT	317281XF03	AB6062AT
BMW - MINI	24152361176	AB6005AT	CADILLAC	24289324	AB6039AT	CHRYSLER	05083122AA	AB6120AT	DACIA - RENAULT	317281XF0A	AB6062AT
BMW - MINI	24311218204	AB6145AT	CADILLAC	24297793	AB6040AT	CHRYSLER	5189838AA	AB6061AT	DACIA - RENAULT	317281XH0A	AB6061AT
BMW - MINI	24311218571	AB6145AT	CADILLAC	96015432	AB6043AT	CHRYSLER	52118789	AB6018AT	DACIA - RENAULT	317281XZ0B	AB6061AT
BMW - MINI	24341219156	AB6148AT	CADILLAC	24290959	AB6054AT	CHRYSLER	68142478AB	AB6164AT	DACIA - RENAULT	317281XZ0D	AB6062AT
BMW - MINI	24341219631	AB6148AT	CADILLAC	24292809	AB6053AT	CHRYSLER	68362041AB	AB6073AT	DACIA - RENAULT	317281XZ0A	AB6062AT
BMW - MINI	24341422513	AB6148AT	CHEVROLET	747477	AB6043AT	CHRYSLER	68417054AB	AB6073AT	DACIA - RENAULT	3172828X0A	AB6067AT
BMW - MINI	24341422673	AB6151AT	CHEVROLET	24041506	AB6050AT	CHRYSLER	83504032	AB6120AT	DACIA - RENAULT	3172829X0D	AB6068AT
BMW - MINI	24341423376	AB6150AT	CHEVROLET	24225323	AB6045AT	CHRYSLER	K68142478AB	AB6164AT	DACIA - RENAULT	3172829X0E	AB6066AT
BMW - MINI	24347551087	AB6006AT	CHEVROLET	24230708	AB6052AT	CHRYSLER	K68225344AA	AB6164AT	DACIA - RENAULT	317283JX0A	AB6065AT
BMW - MINI	24347566358	AB6005AT	CHEVROLET	24237508	AB6051AT	CHRYSLER	K68362041AB	AB6073AT	DACIA - RENAULT	317283JX0B	AB6065AT
BMW - MINI	24722000	AB6047AT	CHEVROLET	24246194	AB6052AT	CHRYSLER	K68417054AB	AB6073AT	DACIA - RENAULT	317283JX0C	AB6065AT
BMW - MINI	28107842385	AB6014AT	CHEVROLET	24251353	AB6052AT	DACIA - RENAULT	172804X0C	AB6065AT	DACIA - RENAULT	317283TX0A	AB6060AT
BMW - MINI	28107842828	AB6014AT	CHEVROLET	24267569	AB6052AT	DACIA - RENAULT	313971XF0A	AB6061AT	DACIA - RENAULT	317283XX0A	AB6065AT
BMW - MINI	28107842840	AB6015AT	CHEVROLET	24268438	AB6040AT	DACIA - RENAULT	313971XF0C	AB6061AT	DACIA - RENAULT	317283XX0B	AB6065AT
BMW - MINI	28107850148	AB6014AT	CHEVROLET	24272927	AB6040AT	DACIA - RENAULT	317261XF00	AB6063AT	DACIA - RENAULT	3172850X0A	AB6065AT

DACIA - RENAULT	31728X480A	AB6062AT	EVOBUS	A1693771395	AB6091AT	EVOBUS	A7252704012	AB6086AT	FCA	5078555AA	AB6022AT
DACIA - RENAULT	7700107587	AB6101AT	EVOBUS	A2012700298	AB6076AT	EVOBUS	A7252707702	AB6088AT	FCA	5179267AC	AB6021AT
DAEWOO	3533080A010	AB6001AT	EVOBUS	A2122770295	AB6085AT	EVOBUS	A7252707911	AB6086AT	FCA	5191890AA	AB6061AT
DAEWOO	93741509	AB6001AT	EVOBUS	A2202770395	AB6083AT	EVOBUS	A7252708704	AB6088AT	FCA	52108325AA	AB6078AT
EVOBUS	7252700408	AB6087AT	EVOBUS	A2202770695	AB6083AT	EVOBUS	A7252708804	AB6088AT	FCA	52852913AB	AB6019AT
EVOBUS	7252701518	AB6087AT	EVOBUS	A220277069505	AB6083AT	EVOBUS	A7252709110	AB6087AT	FCA	52854834AA	AB6170AT
EVOBUS	7252703114	AB6086AT	EVOBUS	A2212770000	AB6082AT	FCA	3410253	AB6023AT	FCA	68018555AA	AB6022AT
EVOBUS	7252704012	AB6086AT	EVOBUS	A2212770095	AB6083AT	FCA	3621456	AB6023AT	FCA	68059549AA	AB6019AT
EVOBUS	7252707911	AB6086AT	EVOBUS	A2212770100	AB6082AT	FCA	7701467106	AB6101AT	FCA	68142478AA	AB6164AT
EVOBUS	7252709110	AB6087AT	EVOBUS	A2212770195	AB6083AT	FCA	8201219252	AB6101AT	FCA	68225344AA	AB6170AT
EVOBUS	2122770295	AB6085AT	EVOBUS	A2212770200	AB6083AT	FCA	152004740R	AB6098AT	FCA	68233701AA	AB6170AT
EVOBUS	7252700712	AB6086AT	EVOBUS	A2222772000	AB6082AT	FCA	168018555AA	AB6022AT	FCA	68233701AB	AB6170AT
EVOBUS	A1262700298	AB6076AT	EVOBUS	A2222772800	AB6082AT	FCA	3515996	AB6023AT	FCA	7700107587	AB6101AT
EVOBUS	A1262700598	AB6076AT	EVOBUS	A2463710780	AB6080AT	FCA	432931C2	AB6023AT	FCA	77367950	AB6164AT
EVOBUS	A1262770295	AB6076AT	EVOBUS	A2463770395	AB6080AT	FCA	4799662AB	AB6021AT	FCA	K03515996	AB6023AT
EVOBUS	A1262770298	AB6076AT	EVOBUS	A2463770495	AB6081AT	FCA	4799662AC	AB6021AT	FCA	K05015267AD	AB6020AT
EVOBUS	A1292770095	AB6077AT	EVOBUS	A2463771400	AB6080AT	FCA	4800029AA	AB6020AT	FCA	K05078555AA	AB6022AT
EVOBUS	A1292770195	AB6077AT	EVOBUS	A2463772300	AB6081AT	FCA	5013470AA	AB6021AT	FCA	K05179267AD	AB6020AT
EVOBUS	A1402770095	AB6078AT	EVOBUS	A2463772400	AB6080AT	FCA	5013470AB	AB6021AT	FCA	K68018555AA	AB6022AT
EVOBUS	A1683770295	AB6089AT	EVOBUS	A7222770095	AB6079AT	FCA	5013470AC	AB6021AT	FCA	K68142478AB	AB6164AT
EVOBUS	A1683770395	AB6089AT	EVOBUS	A7252700408	AB6087AT	FCA	5013470AD	AB6021AT	FCA	K68225344AA	AB6164AT
EVOBUS	A1693770995	AB6091AT	EVOBUS	A7252701518	AB6087AT	FCA	5015267AC	AB6020AT	FCA	KJ8123042	AB6023AT
EVOBUS	A1693771195	AB6091AT	EVOBUS	A7252703114	AB6086AT	FCA	5015267AD	AB6020AT	FCA	KJ8126768	AB6023AT
EVOBUS	A1693771295	AB6091AT	EVOBUS	A7252703707	AB6088AT	FCA	5073878AA	AB6078AT	FCA	MD673110	AB6094AT

FCA	MD758684	AB6092AT	FEBI	176877	AB6099AT	FORD	1589089	AB6098AT	HYUNDAI - KIA	4632126000	AB6057AT
FCA	MD758691	AB6092AT	FEBI	180577	AB6104AT	FORD	2303133	AB6035AT	HYUNDAI - KIA	463212F000	AB6055AT
FCA	MR357710	AB6093AT	FEBI	180578	AB6106AT	FORD	2335955	AB6041AT	HYUNDAI - KIA	463212Z000	AB6059AT
FCA	MR528836	AB6094AT	FEBI	180604	AB6104AT	FORD	2379800	AB6035AT	HYUNDAI - KIA	463212Z010	AB6059AT
FEBI	100250	AB6084AT	FEBI	180604	AB6106AT	FORD	2401937	AB6041AT	HYUNDAI - KIA	463213B000	AB6056AT
FEBI	100250	AB6083AT	FEBI	194616	AB6084AT	FORD	3044026	AB6033AT	HYUNDAI - KIA	463213B600	AB6057AT
FEBI	100398	AB6157AT	FEBI	194616	AB6083AT	FORD	5046305	AB6033AT	HYUNDAI - KIA	KFU6121500	AB6059AT
FEBI	100399	AB6157AT	FEBI	24538	AB6084AT	FORD	5430977	AB6041AT	HYUNDAI - KIA	KFW0121500	AB6059AT
FEBI	104788	AB6099AT	FEBI	24538	AB6083AT	FORD	6E5Z7B155A	AB6034AT	HYUNDAI - KIA	MFU6121500B	AB6059AT
FEBI	105812	AB6153AT	FEBI	30157	AB6084AT	FORD	6L2Z7A098AA	AB6156AT	HYUNDAI - KIA	OK01519815	AB6059AT
FEBI	107405	AB6159AT	FEBI	30157	AB6083AT	FORD	7M5R7G186AC	AB6100AT	HYUNDAI / KIA	463214G100	AB6058AT
FEBI	107826	AB6032AT	FEBI	44530	AB6084AT	FORD	7M5R7G186AE	AB6100AT	IVECO	42577152	AB6164AT
FEBI	107830	AB6153AT	FEBI	44530	AB6083AT	FORD	E4LY7A098A	AB6144AT	JAGUAR	JDE26442	AB6164AT
FEBI	109626	AB6096AT	FEBI	48368	AB6155AT	FORD	F1CZ7A098A	AB6059AT	JAGUAR	JDE36541	AB6164AT
FEBI	14256	AB6135AT	FORD	2245798	AB6100AT	FORD	HL3P7G186CA	AB6041AT	JAGUAR	JLM650	AB6147AT
FEBI	14258	AB6133AT	FORD	21015020	AB6100AT	FORD	HL3P7P086	AB6161AT	JAGUAR	JLM664	AB6144AT
FEBI	171195	AB6099AT	FORD	501315183	AB6143AT	FORD	HL3Z7A098A	AB6041AT	JAPANPARTS	FT018	AB6157AT
FEBI	171640	AB6159AT	FORD	1305775	AB6038AT	FORD	J1KP7G186AD	AB6035AT	JAPANPARTS	FT019	AB6157AT
FEBI	171642	AB6159AT	FORD	1305783	AB6038AT	FORD	J1KP7G186AE	AB6035AT	JAPANPARTS	FT032	AB6084AT
FEBI	171750	AB6084AT	FORD	1406310	AB6038AT	FORD	J1KZ7B301A	AB6036AT	JAPANPARTS	FT032	AB6083AT
FEBI	171750	AB6083AT	FORD	1493239	AB6098AT	FORD	J1KZ7F396A	AB6035AT	JAPANPARTS	FT033	AB6084AT
FEBI	171772	AB6032AT	FORD	1498784	AB6037AT	FORD	J1KZ7G186A	AB6035AT	JAPANPARTS	FT033	AB6083AT
FEBI	176671	AB6153AT	FORD	1564960	AB6098AT	FORD	L1MZ7A098A	AB6041AT	JAPANPARTS	FT035	AB6084AT
FEBI	176875	AB6157AT	FORD	1564965	AB6098AT	HUMMER	24225323	AB6045AT	JAPANPARTS	FT035	AB6083AT

JAPANPARTS	FT055	AB6153AT	JAPKO	FTJ098	AB6084AT	MASERATI	673011113	AB6164AT	MERCEDES - SMART	A1262770295	AB6076AT
JAPANPARTS	FT056	AB6159AT	JAPKO	FTJ098	AB6083AT	MAZDA	AW0121500	AB6009AT	MERCEDES - SMART	A1262770298	AB6076AT
JAPANPARTS	FT058	AB6153AT	JAPKO	FTJ161	AB6104AT	MAZDA	FN0121500	AB6033AT	MERCEDES - SMART	A1292770095	AB6077AT
JAPANPARTS	FT061	AB6032AT	JAPKO	FTJ161	AB6106AT	MAZDA	FN0121500A	AB6033AT	MERCEDES - SMART	A1292770195	AB6077AT
JAPANPARTS	FT064	AB6096AT	LAMBORGHINI	0D6398359	AB6174AT	MAZDA	FNC121500	AB6034AT	MERCEDES - SMART	A1402770095	AB6078AT
JAPANPARTS	FT078	AB6099AT	LAND ROVER	0501218843	AB6176AT	MAZDA	FNC121500A	AB6034AT	MERCEDES - SMART	A1683770295	AB6089AT
JAPANPARTS	FT098	AB6084AT	LAND ROVER	1043226011	AB6146AT	MAZDA	FP0121500	AB6070AT	MERCEDES - SMART	A1683770395	AB6089AT
JAPANPARTS	FT098	AB6083AT	LAND ROVER	1043226037	AB6146AT	MAZDA	FU6121500	AB6059AT	MERCEDES - SMART	A1693770995	AB6091AT
JAPANPARTS	FT161	AB6104AT	LAND ROVER	LR007474	AB6163AT	MAZDA	FU6121500B	AB6059AT	MERCEDES - SMART	A1693771195	AB6091AT
JAPANPARTS	FT161	AB6106AT	LAND ROVER	LR023294	AB6164AT	MAZDA	FZ0121500	AB6074AT	MERCEDES - SMART	A1693771295	AB6091AT
JAPKO	FTJ018	AB6157AT	LAND ROVER	LR053470	AB6171AT	MAZDA	FZ1121500	AB6075AT	MERCEDES - SMART	A1693771395	AB6091AT
JAPKO	FTJ019	AB6157AT	LAND ROVER	LR065238	AB6164AT	MAZDA	R2Y110431A	AB6074AT	MERCEDES - SMART	A2012700298	AB6076AT
JAPKO	FTJ032	AB6084AT	LAND ROVER	RTC4653	AB6146AT	MAZDA	XS4Z7A098AB	AB6033AT	MERCEDES - SMART	A2122770295	AB6085AT
JAPKO	FTJ032	AB6083AT	LAND ROVER	TED500010	AB6163AT	MERCEDES - SMART	7252700408	AB6087AT	MERCEDES - SMART	A2202770395	AB6083AT
JAPKO	FTJ033	AB6084AT	LAND ROVER	THE500030	AB6048AT	MERCEDES - SMART	7252701518	AB6087AT	MERCEDES - SMART	A2202770695	AB6083AT
JAPKO	FTJ033	AB6083AT	LAND ROVER	THE500031	AB6048AT	MERCEDES - SMART	7252703114	AB6086AT	MERCEDES - SMART	A220277069505	AB6083AT
JAPKO	FTJ035	AB6084AT	LEXUS	3530330060	AB6003AT	MERCEDES - SMART	7252704012	AB6086AT	MERCEDES - SMART	A2212770000	AB6082AT
JAPKO	FTJ035	AB6083AT	LEXUS	3533052010	AB6001AT	MERCEDES - SMART	7252707911	AB6086AT	MERCEDES - SMART	A2212770095	AB6083AT
JAPKO	FTJ055	AB6153AT	MAN	65331180001	AB6164AT	MERCEDES - SMART	7252709110	AB6087AT	MERCEDES - SMART	A2212770100	AB6082AT
JAPKO	FTJ056	AB6159AT	MANN FILTER	H27001	AB6084AT	MERCEDES - SMART	1019222019	AB6143AT	MERCEDES - SMART	A2212770195	AB6083AT
JAPKO	FTJ058	AB6153AT	MANN FILTER	H27001	AB6083AT	MERCEDES - SMART	2122770295	AB6085AT	MERCEDES - SMART	A2212770200	AB6083AT
JAPKO	FTJ061	AB6032AT	MANN FILTER	H6005Z	AB6032AT	MERCEDES - SMART	7252700712	AB6086AT	MERCEDES - SMART	A2222772000	AB6082AT
JAPKO	FTJ064	AB6096AT	MASERATI	673003178	AB6164AT	MERCEDES - SMART	A1262700298	AB6076AT	MERCEDES - SMART	A2222772800	AB6082AT
JAPKO	FTJ078	AB6099AT	MASERATI	673005766	AB6164AT	MERCEDES - SMART	A1262700598	AB6076AT	MERCEDES - SMART	A2463710780	AB6080AT

MERCEDES - SMART	A2463770395	AB6080AT	MEYLE	014 137 1007	AB6084AT	MEYLE	100 136 0010	AB6159AT	mitsubishi	2824A018	AB6066AT
MERCEDES - SMART	A2463770495	AB6081AT	MEYLE	014 137 1007	AB6083AT	MEYLE	100 136 0011	AB6155AT	mitsubishi	2824A021	AB6065AT
MERCEDES - SMART	A2463771400	AB6080AT	MEYLE	100 135 0003	AB6155AT	MEYLE	100 136 1007	AB6106AT	mitsubishi	2824A025	AB6063AT
MERCEDES - SMART	A2463772300	AB6081AT	MEYLE	100 135 0003/SK	AB6155AT	MEYLE	100 136 1008	AB6104AT	mitsubishi	2921A007	AB6064AT
MERCEDES - SMART	A2463772400	AB6080AT	MEYLE	100 135 0003/XK	AB6155AT	MEYLE	100 137 0009	AB6153AT	mitsubishi	MD673110	AB6094AT
MERCEDES - SMART	A7222770095	AB6079AT	MEYLE	100 135 0004	AB6159AT	MEYLE	100 137 0012	AB6153AT	mitsubishi	MD758684	AB6092AT
MERCEDES - SMART	A7252700408	AB6087AT	MEYLE	100 135 0004/SK	AB6159AT	MEYLE	100 325 0001	AB6135AT	mitsubishi	MD758691	AB6092AT
MERCEDES - SMART	A7252701518	AB6087AT	MEYLE	100 135 0005	AB6153AT	MEYLE	100 325 0002	AB6133AT	mitsubishi	MR195988	AB6120AT
MERCEDES - SMART	A7252703114	AB6086AT	MEYLE	100 135 0005/SK	AB6153AT	MEYLE	100 325 0011	AB6153AT	mitsubishi	MR357710	AB6093AT
MERCEDES - SMART	A7252703707	AB6088AT	MEYLE	100 135 0005/XK	AB6153AT	MEYLE	300 135 1006	AB6157AT	mitsubishi	MR528836	AB6094AT
MERCEDES - SMART	A7252704012	AB6086AT	MEYLE	100 135 0103	AB6032AT	MEYLE	300 135 1006/SK	AB6157AT	NISSAN	31728PR001	AB6070AT
MERCEDES - SMART	A7252707702	AB6088AT	MEYLE	100 135 0103/SK	AB6032AT	MEYLE	300 137 0002	AB6157AT	NISSAN	31728PW001	AB6071AT
MERCEDES - SMART	A7252707911	AB6086AT	MEYLE	100 135 0103/XK	AB6032AT	MEYLE	314 316 0001	AB6157AT	NISSAN	31728PW003	AB6072AT
MERCEDES - SMART	A7252708704	AB6088AT	MEYLE	100 135 0110	AB6153AT	MEYLE	714 135 0002	AB6099AT	NISSAN - INFINITI	15208HG00J	AB6081AT
MERCEDES - SMART	A7252708804	AB6088AT	MEYLE	100 135 0110/SK	AB6153AT	MEYLE	714 135 0102	AB6099AT	NISSAN - INFINITI	172804X0C	AB6065AT
MERCEDES - SMART	A7252709110	AB6087AT	MEYLE	100 135 0110/XK	AB6153AT	MEYLE	714 135 0102/XK	AB6099AT	NISSAN - INFINITI	31391X280A	AB6088AT
MEYLE	014 135 1202	AB6084AT	MEYLE	100 135 0115	AB6104AT	MEYLE	714 137 0002	AB6099AT	NISSAN - INFINITI	313971XF0A	AB6061AT
MEYLE	014 135 1202	AB6083AT	MEYLE	100 135 0115	AB6106AT	mitsubishi	2513A040	AB6098AT	NISSAN - INFINITI	313971XF0C	AB6061AT
MEYLE	014 135 1202/XK	AB6084AT	MEYLE	100 135 0115/SK	AB6104AT	mitsubishi	2705A015	AB6061AT	NISSAN - INFINITI	317261XF00	AB6063AT
MEYLE	014 135 1202/XK	AB6083AT	MEYLE	100 135 0115/SK	AB6106AT	mitsubishi	2804A020	AB6122AT	NISSAN - INFINITI	317261XZ0A	AB6063AT
MEYLE	014 135 1212	AB6084AT	MEYLE	100 135 0115/XK	AB6104AT	mitsubishi	2804A032	AB6011AT	NISSAN - INFINITI	3172628X0A	AB6064AT
MEYLE	014 135 1212	AB6083AT	MEYLE	100 135 0115/XK	AB6106AT	mitsubishi	2824A004	AB6061AT	NISSAN - INFINITI	317263JX0A	AB6064AT
MEYLE	014 136 0000	AB6084AT	MEYLE	100 136 0004	AB6032AT	mitsubishi	2824A006	AB6063AT	NISSAN - INFINITI	317263XX0A	AB6064AT
MEYLE	014 136 0000	AB6083AT	MEYLE	100 136 0009	AB6153AT	mitsubishi	2824A007	AB6061AT	NISSAN - INFINITI	317266A00A	AB6065AT

NISSAN - INFINITI	31726HG00A	AB6082AT	OPEL	24230708	AB6052AT	PORSCHE	95530740301	AB6010AT	QUALITY TESTED	FT055JM	AB6153AT
NISSAN - INFINITI	31726HG00B	AB6082AT	OPEL	24237508	AB6051AT	PORSCHE	98630740300	AB6149AT	QUALITY TESTED	FT056JM	AB6159AT
NISSAN - INFINITI	3172804X0B	AB6065AT	OPEL	24246194	AB6052AT	PORSCHE	9A731707000	AB6044AT	QUALITY TESTED	FT058JM	AB6153AT
NISSAN - INFINITI	317281XA00	AB6062AT	OPEL	24251353	AB6052AT	PORSCHE	9A731718900	AB6044AT	QUALITY TESTED	FT061JM	AB6032AT
NISSAN - INFINITI	317281XF02	AB6061AT	OPEL	24267569	AB6052AT	PORSCHE	PAB398009	AB6169AT	QUALITY TESTED	FT064JM	AB6096AT
NISSAN - INFINITI	317281XF03	AB6062AT	OPEL	24268438	AB6040AT	PORSCHE	PAB39800901	AB6169AT	QUALITY TESTED	FT078JM	AB6099AT
NISSAN - INFINITI	317281XF0A	AB6062AT	OPEL	24272927	AB6040AT	PSA	226336	AB6061AT	QUALITY TESTED	FT098JM	AB6084AT
NISSAN - INFINITI	317281XH0A	AB6061AT	OPEL	24289324	AB6039AT	PSA	221414	AB6061AT	QUALITY TESTED	FT098JM	AB6083AT
NISSAN - INFINITI	317281XZ0B	AB6061AT	OPEL	24297793	AB6040AT	PSA	226322	AB6142AT	QUALITY TESTED	FT161JM	AB6104AT
NISSAN - INFINITI	317281XZ0D	AB6062AT	OPEL	96015432	AB6043AT	PSA	226709	AB6098AT	QUALITY TESTED	FT161JM	AB6106AT
NISSAN - INFINITI	317281XZ0A	AB6062AT	OPEL	96042545	AB6046AT	PSA	2644086Z00	AB6143AT	REDLINE	72AU000	AB6096AT
NISSAN - INFINITI	3172828X0A	AB6067AT	OPEL	24263302	AB6050AT	PURFLUX	TEK014	AB6153AT	RENAULT	8983504032	AB6120AT
NISSAN - INFINITI	3172829X0D	AB6068AT	OPEL	24268086	AB6050AT	PURFLUX	TEK047	AB6084AT	ROLLS ROYCE	24117624192	AB6164AT
NISSAN - INFINITI	3172829X0E	AB6066AT	OPEL	24290959	AB6054AT	PURFLUX	TEK047	AB6083AT	ROLLS ROYCE	24118612901	AB6164AT
NISSAN - INFINITI	317283JX0A	AB6065AT	OPEL	24292809	AB6053AT	PURFLUX	TK008	AB6099AT	ROLLS ROYCE	24152333903	AB6163AT
NISSAN - INFINITI	317283JX0B	AB6065AT	OPEL	7599525	AB6142AT	PURFLUX	TK011	AB6032AT	SSANGYONG	1402770095	AB6078AT
NISSAN - INFINITI	317283JX0C	AB6065AT	OPEL	90444592	AB6004AT	QUALITY TESTED	FT018JM	AB6157AT	SSANGYONG	0578738007	AB6017AT
NISSAN - INFINITI	317283TX0A	AB6060AT	OPEL	93741509	AB6001AT	QUALITY TESTED	FT019JM	AB6157AT	SSANGYONG	2222772000	AB6082AT
NISSAN - INFINITI	317283XX0A	AB6065AT	PORSCHE	501222921	AB6044AT	QUALITY TESTED	FT032JM	AB6084AT	SUBARU	31726AN800	AB6116AT
NISSAN - INFINITI	317283XX0B	AB6065AT	PORSCHE	1262700298	AB6076AT	QUALITY TESTED	FT032JM	AB6083AT	SUBARU	31728AA050	AB6115AT
NISSAN - INFINITI	3172850X0A	AB6065AT	PORSCHE	96030790101	AB6076AT	QUALITY TESTED	FT033JM	AB6084AT	SUBARU	31728AA120	AB6114AT
NISSAN - INFINITI	31728X480A	AB6062AT	PORSCHE	1262770295	AB6076AT	QUALITY TESTED	FT033JM	AB6083AT	SUBARU	31728AA121	AB6114AT
OPEL	747477	AB6043AT	PORSCHE	7222770095	AB6079AT	QUALITY TESTED	FT035JM	AB6084AT	SUBARU	31728AA141	AB6113AT
OPEL	24041506	AB6050AT	PORSCHE	95530740300	AB6010AT	QUALITY TESTED	FT035JM	AB6083AT	SUBARU	31728AA180	AB6112AT



CATALOGO CROSS REFERENCE

SUBARU	31835AA030	AB6111AT	TOYOTA	3530330060	AB6003AT	TOYOTA - LEXUS	3533060060	AB6123AT	VAG	09A325429A	AB6072AT
SUBARU	38325AA030	AB6116AT	TOYOTA	3533052010	AB6001AT	VAG	21024500	AB6097AT	VAG	09D325429	AB6010AT
SUBARU	38325AA031	AB6116AT	TOYOTA - LEXUS	3014012021	AB6128AT	VAG	095325429C	AB6132AT	VAG	09D325435	AB6010AT
SUBARU	38325AA032	AB6116AT	TOYOTA - LEXUS	3533012050	AB6130AT	VAG	001325429A	AB6069AT	VAG	09G325429	AB6136AT
SUZUKI	2644560G10	AB6004AT	TOYOTA - LEXUS	3533012080	AB6126AT	VAG	018325433B	AB6147AT	VAG	09G325429A	AB6137AT
SUZUKI	2644579C10	AB6001AT	TOYOTA - LEXUS	3533028020	AB6124AT	VAG	01F321371	AB6141AT	VAG	09G325429D	AB6139AT
SUZUKI	2657054J10	AB6122AT	TOYOTA - LEXUS	3533030010	AB6140AT	VAG	01F325433	AB6141AT	VAG	09G325429E	AB6138AT
SUZUKI	2657076J10	AB6117AT	TOYOTA - LEXUS	3533030011	AB6140AT	VAG	01J301517B	AB6012AT	VAG	09K325429	AB6007AT
SUZUKI	2658257B00	AB6003AT	TOYOTA - LEXUS	3533033050	AB6131AT	VAG	01J301517D	AB6013AT	VAG	09L325429	AB6154AT
TECNECO	AT110	AB6153AT	TOYOTA - LEXUS	3533039565	AB6124AT	VAG	01J301519L	AB6012AT	VAG	09M325429	AB6008AT
TECNECO	AT115	AB6032AT	TOYOTA - LEXUS	3533047230	AB6130AT	VAG	01L325429	AB6151AT	VAG	09P321370	AB6002AT
TECNECO	AT130	AB6157AT	TOYOTA - LEXUS	3533048020	AB6131AT	VAG	01M325429	AB6134AT	VAG	09P325429	AB6002AT
TECNECO	AT136	AB6099AT	TOYOTA - LEXUS	3533058020	AB6124AT	VAG	01N321371	AB6135AT	VAG	0AM325433D	AB6024AT
TECNECO	AT140	AB6084AT	TOYOTA - LEXUS	310311312	AB6127AT	VAG	01V325429	AB6149AT	VAG	0AM325433E	AB6024AT
TECNECO	AT140	AB6083AT	TOYOTA - LEXUS	3501512010	AB6125AT	VAG	01V398003	AB6149AT	VAG	0AT325429	AB6152AT
TECNECO	AT153	AB6096AT	TOYOTA - LEXUS	353300C010	AB6123AT	VAG	095321371	AB6134AT	VAG	0AW301516C	AB6095AT
TECNECO	AT173	AB6135AT	TOYOTA - LEXUS	353300W050	AB6128AT	VAG	095325429D	AB6132AT	VAG	0AW301516D	AB6095AT
TESLA	109503800A	AB6119AT	TOYOTA - LEXUS	353300W060	AB6129AT	VAG	095325443	AB6132AT	VAG	0AW301516E	AB6095AT
TESLA	161553000B	AB6118AT	TOYOTA - LEXUS	353300W080	AB6129AT	VAG	095325443A	AB6132AT	VAG	0AW301516G	AB6095AT
TOYOTA	3533060080	AB6011AT	TOYOTA - LEXUS	3533012090	AB6126AT	VAG	095398002	AB6132AT	VAG	0AW301516H	AB6095AT
TOYOTA	1693771395	AB6091AT	TOYOTA - LEXUS	3533033001	AB6140AT	VAG	095398009	AB6132AT	VAG	0AW301519C	AB6097AT
TOYOTA	35106WAA03	AB6164AT	TOYOTA - LEXUS	3533034010	AB6123AT	VAG	095398425	AB6132AT	VAG	0B6325429	AB6160AT
TOYOTA	35106WAA04	AB6164AT	TOYOTA - LEXUS	3533060040	AB6121AT	VAG	096321370	AB6132AT	VAG	0BH325429B	AB6029AT
TOYOTA	3516852010	AB6001AT	TOYOTA - LEXUS	3533060050	AB6122AT	VAG	09A325429	AB6071AT	VAG	0BH325429C	AB6029AT

VAG	OBK398009	AB6166AT	VAICO	V10-2218	AB6153AT	VAICO	V10-5390-XXL	AB6104AT	VAICO	V30-7550	AB6084AT
VAG	OBK398009A	AB6166AT	VAICO	V10-2287-1	AB6032AT	VAICO	V10-5390-XXL	AB6106AT	VAICO	V30-7550	AB6083AT
VAG	0BT325429A	AB6030AT	VAICO	V10-2354	AB6155AT	VAICO	V10-5391	AB6104AT	VOLVO	13397252	AB6144AT
VAG	0BW398009	AB6167AT	VAICO	V10-3014	AB6159AT	VAICO	V10-5391	AB6106AT	VOLVO	31256837	AB6098AT
VAG	0C8325435	AB6011AT	VAICO	V10-3016	AB6159AT	VAICO	V10-5393	AB6104AT	VOLVO	31259415	AB6098AT
VAG	0CK325121D	AB6105AT	VAICO	V10-3016-1	AB6159AT	VAICO	V10-5394	AB6106AT	VOLVO	60270F0990080	AB6009AT
VAG	0CK325149D	AB6104AT	VAICO	V10-3017	AB6159AT	VAICO	V10-5953	AB6104AT	ZF	0501212401	AB6155AT
VAG	0CK325421A	AB6102AT	VAICO	V10-3021	AB6096AT	VAICO	V20-0046	AB6157AT	ZF	0501212974	AB6159AT
VAG	0CM301519	AB6165AT	VAICO	V10-3216	AB6153AT	VAICO	V20-0048	AB6157AT	ZF	0501223001	AB6153AT
VAG	0D5398009	AB6168AT	VAICO	V10-3216-BEK	AB6153AT	VAICO	V20-2081	AB6157AT	ZF	1068298061	AB6157AT
VAG	0D5398009A	AB6169AT	VAICO	V10-3219	AB6153AT	VAICO	V20-2081-BEK	AB6157AT	ZF	1068298084	AB6157AT
VAG	0D6398359	AB6174AT	VAICO	V10-3219-BEK	AB6153AT	VAICO	V25-0130	AB6099AT	ZF	1071298027	AB6155AT
VAG	0D6398359A	AB6175AT	VAICO	V10-3223	AB6032AT	VAICO	V25-0796	AB6099AT	ZF	1071298027	AB6159AT
VAG	0DE325429C	AB6028AT	VAICO	V10-3223-XXL	AB6032AT	VAICO	V25-0796-XXL	AB6099AT	ZF	1071298039	AB6155AT
VAG	0DR301519	AB6164AT	VAICO	V10-3229	AB6159AT	VAICO	V30-2258	AB6084AT	ZF	1071298039	AB6159AT
VAG	95832543500	AB6011AT	VAICO	V10-3229-BEK	AB6159AT	VAICO	V30-2258	AB6083AT	ZF	1084298013	AB6153AT
VAG	9A325429A	AB6072AT	VAICO	V10-3230	AB6159AT	VAICO	V30-2258-BEK	AB6084AT	ZF	1084298014	AB6153AT
VAG	A0002772695	AB6134AT	VAICO	V10-3230-BEK	AB6159AT	VAICO	V30-2258-BEK	AB6083AT	ZF	5961303474	AB6084AT
VAICO	V10-0381	AB6135AT	VAICO	V10-3231	AB6096AT	VAICO	V30-2258-XXL	AB6084AT	ZF	5961303474	AB6083AT
VAICO	V10-0383	AB6133AT	VAICO	V10-3231-XXL	AB6096AT	VAICO	V30-2258-XXL	AB6083AT	ZF	5961304069	AB6099AT
VAICO	V10-1866	AB6153AT	VAICO	V10-5390	AB6104AT	VAICO	V30-7455	AB6084AT	ZF	5961306996	AB6032AT
VAICO	V10-1868	AB6153AT	VAICO	V10-5390	AB6106AT	VAICO	V30-7455	AB6083AT	ZF	5961308372	AB6084AT
VAICO	V10-1868-1	AB6153AT	VAICO	V10-5390-BEK	AB6104AT	VAICO	V30-7524	AB6084AT	ZF	5961308372	AB6083AT
VAICO	V10-2216	AB6153AT	VAICO	V10-5390-BEK	AB6106AT	VAICO	V30-7524	AB6083AT	ZF	5961308444	AB6096AT



CATALOGO CROSS REFERENCE

ZF 5961308602 **AB6032AT**

ZF 5961309120 **AB6084AT**

ZF 5961309120 **AB6083AT**



 www.abparts.it

 info@abparts.it

